



HER KİLOMETREDE YENİ / NEWER IN EVERY MILE

OTOBÜS EGZOZLARI EXHAUST SYSTEMS FOR BUSES

ÜRÜN KATALOĞU

PRODUCT CATALOGUE

Tecrübemizden gelen üstün mühendislik ve işçilik kalitesiyle geliştirdiğimiz, yeni nesil egzoz sistemlerimiz artık daha uzun ömürlü.

Our new generation exhaust systems, which we have developed with our superior engineering and workmanship from our experience, now have a longer life.



www.soylu.com

HER KİLOMETREDE YENİ / NEWER IN EVERY MILE

Daha iyisini yapmak için çıktığımız bu yolda,
Müşterilerimizin işine değer katacak parçaları üretiyoruz.
Sert koşullarda sağlam kalabilmeyi gerektiren işimiz,
Malzeme üzerinde en iyi sonucu almayı gerektiriyor.
Aracınızın ne istediğini bilen deneyimli mühendislerimizin,
Kaliteden ödün vermeyen çalışanlarımızın,
Kendini işine adanmış yönetim kadromuzun,
Tek amacı bunu gerçekleştirebilmek:
Köklerimizden gelen kalite ve yeniliği her kilometrede sunabilmektir.
Yerel üretimimiz, geniş servis ağıımız ve kolay tedarik hizmetlerimiz ile;
Ülkemizde üreten bir değer olma gayesiyle yükseliyoruz.

On this road we went out to do better,
We produce parts that will add value to our customers.
Our job is to be able to remain firm in harsh conditions,
It requires the best finish on the material.
Our experienced engineers, who know what your car wants,
Our employees who do not compromise in quality,
We have a dedicated management team,
The only goal is to be able to do this:
Quality and innovation from our roots can be offered every kilometer.
With our local production, extensive service network and easy
procurement services;
We rise up to be a value producing in our country.

www.soylu.com



OTOBÜS EGZOZLARI

ÜRÜN KATALOĞU

PRODUCT CATALOGUE

OTOBÜS EGZOZLARI

İÇİNDEKİLER / CONTENTS

Soylu'ya Bakış / About The Soylu	6
Ayats	10
Bova	12
Bredamenarini	22
DAF	25
Drögmöller	33
Iveco	35
MAN	53
Mercedes	174

Neoplan	363
Renault	382
Scania	416
Setra	455
Solaris	503
TEMSA	508
Van Hool	513
Volvo	517
VW	577

SOYLU'YA BAKIŞ/ ABOUT THE SOYLU

Soylu Ltd. 2001 yılında İstanbul Dolapdere Sanayi Sitesinde Yönetim Kurulu Başkanımız Sn. Niyazi Soylu tarafından kurulmuştur. 2018 yılında Merkezi İstanbul'da olmak üzere; üretimi Düzce Gümüşova ilçesinde 9.000 metrekare kapalı 3000 metrekare açık alanlı fabrikasına taşınmaktadır. Her nevi motorlu araçların egzoz sistemleri üreticisi olarak faaliyet göstermeye başlayan Soylu Ltd. takip eden yıllarda, hava tankları ve yakıt depoları için pazarda güçlü bir talebin var olduğu neticesiyle ürün gamına eklemiştir.

Soylu Ltd. ürünleri için gerekli tüm bileşenleri kendi bünyesinde üretmekte olup, tüm üretim süreçleri ve satış sonrası hizmetlerde kalite yönetim sistemi doğrultusunda hareket ederek, güncel teknolojileri yakından takip etmektedir. Kullanılan tüm kalıplar, aparatlar Soylu Ltd. bünyesinde tasarlanmakta (thinkdesign) ve CAD/CAM programları ile (Mastercam, Machining Strategist) CNC tezgâhları kullanılarak, ISO 9001-2008 Kalite Yönetim Sistemi ile sertifikalandırıp Dünya standartlarında üretim gerçekleştirmektedir.

OEM ve After Market piyasasında ihtiyaçlara yönelik her türlü teknolojik altyapıya sahip olan Soylu Ltd. tesisleri'nde, sektörün ihtiyaçlarına yönelik çözüm üretmeye devam ediyor.

Daha iyisini yapmak için çıktığımız bu yolda müşterilerimizin işine değer katacak parçaları üretiyoruz. Yerel üretimimiz, geniş servis ağımız ve kolay tedarik hizmetlerimiz ile; ülkemizde üreten bir değer olma gayesiyle yükseliyoruz.

Soylu Ltd. siz değerli müşterilerine hizmet vermenin haklı gururunu yaşamaktadır.

Soylu Ltd. was established in 2001 by Mr. Niyazi Soylu, the Chairman of the Board of Directors, at Dolapdere Industry area in Istanbul. The Head office was originally located in Istanbul, however, in 2018, production was moved to Düzce, to a new 3000m2 open area and 9000 m2 closed area factory. Soylu Ltd. started operation as a producer of exhaust systems for a diverse variety of motor vehicles. In the following years, due to a strong market demand for air and fuel tanks, these were also added to the range of products that Soylu Ltd. offers.

Soylu Ltd. produces all the necessary components for its products in accordance with a rigorous quality management system that is utilized throughout all production processes. All molds and apparatuses used by Soylu Ltd. are designed via (ThinkDesign) and CAD /CAM programs (Mastercam, Machining Strategist) and built using CNC machines, achieving ISO 9001-2008 Quality Management System certification. Soylu Ltd., which has the technological infrastructure for all needs in OEM and After Market facilities, continues to produce solutions for the needs of the industry.

In order to do better, we produce parts that will add value to our customers. With our local production, extensive service network and easy procurement services; we rise up to be a value producing in our country.

Soylu Ltd. is rightfully proud of serving our esteemed customers.

VİZYON / VISION

Otomotiv sektöründe, farklılıklar yaratarak ve sürekli büyüyerek, liderlik konumunu sürdüren bir marka olmak.

To secure the leading position within the automotive industry through innovative differences and continual growth.

STRATEJİ / STRATEGY

VERİMLİLİK:

- Sektörün en verimli şirketi haline gelme,
- Operasyonel verimlilik kapsamında ürün kalitesinin artırılması ve üretim maliyetlerinin düşürülmesini sağlama,
- Satış maliyetlerini azaltarak dağıtım kanallarında ve satış noktalarında daha verimli ve etkin olmasını sağlama.

MARKA YATIRIMLARI:

- Marka yatırımlarımızı sürekli kılma,
- Yeni ve kuvvetli ürünlerin tüketicilere sunulması,
- Talebi yaratacak, tüketimi arttıracak inovasyonları başarma.

STRATEJİMİZ KAPSAMINDA:

- Bölgesel güç olacak şekilde genişleme,
- Geniş Coğrafyada yeni pazarlara ulaşma,
- Sinerji çalışmalarını hem sahada hem üretimde uygulama,
- En iyi seviyede kurumsal yönetim uygulamalarını sürdürme,

Büyüyen Türkiye otomotiv sektöründe, Şirketimizin sürdürülebilir ve istikrarlı büyüme stratejisine dayanarak, çalışanlarımızla ve Şirket

IN THE AREA OF PRODUCTIVITY, WE AIM TO:

- Become the most productive company in the industry,
- Boost product quality through operational efficiency efforts and slash production costs,
- Achieve further efficiency and productivity in distribution channels and sales points by cutting sales costs.

IN BRAND INVESTMENTS, WE AIM TO:

- Ensure the continuity of our brand investments,
- Launch of new and strong products,
- Achieve success in innovation and lead higher demand consumption,

WITHIN THE CONTEXT OF STRATEGY, WE AIM TO:

- Expand to become a strong regional player,
 - Serving new consumers in wide geography,
 - Synergy studies both in the field and in production,
 - Implement and maintain good corporate governance practices at the highest level,
- Based on our Company's sustainable and stable growth

dışındaki müşterilerimizle sinerji içerisinde, inovasyon ve teknolojiyi kullanarak geliştireceğimiz yeni uygulamaları sektörde ilk hayata geçiren kurum olmayı hedefliyoruz. Bununla birlikte, ana ve yardımcı faaliyet kollarımızla ve hizmetlerimizle kaliteyi sürekli artırmak ve tüm paydaşlarımızı mutlu eden sonuçlara ulaşma hedefleriyle çalışıyoruz.

strategy in the growing Turkish automotive industry and in synergy with our employees and customers, we aim at being the first institution that implements newly developed applications using innovation and technology. Accordingly, we see it as our priority to work on new projects to continuously increase the quality and to we are working to reach to be happy our all stakeholders.

KALİTE / QUALITY

1. AMAÇ: Soylu Ltd. merkezi ve üretim destek süreçlerinin ve grubun koordinasyonunu yapar.

2. POLİTİKA: Mükemmel is modeli geliştirilmesi ve devam ettirilmesi amacıyla kalite yönetim sistemi tüm fonksiyonlarda aşağıdaki hedeflerin gerçekleşmesi için is süreçlerine katkıda bulunur.

2.1. ÇALIŞANLAR: Tüm çalışanlarda is performanslarının parça ve proses kalitesine etkisi, aktif olarak kalite ile ilgili süreçlerde rol almaları ve iletişimi verimli hale getirmeleri bilinci geliştirilir.

2.2. MÜŞTERİLER: Müşteri ihtiyaçlarının karşılanması ve müşteri memnuniyetinin artırılması.

2.3. TEDARİKÇİLER: Tedarikçilerimizin Kalite, Sevkiyat ve Servis performansları sürekli iyileştirme kapsamında değerlendirilir ve geliştirilir.

2.4. PROSESLER: Firma hedefleri ve Müşteri memnuniyeti doğrultusunda proseslerin verimliliği sürekli geliştirilerek

1. PURPOSE: Soylu Exhaust Systems ensure coordination for central and production support processes and group.

2. POLICY: Quality Management System contributes to business processes to achieve the following goals for all functions with the purpose of developing and maintaining an excellent business model.

2.1. EMPLOYEES: The consciousness is raised for all employees in order that they have an effect on part and process quality thanks to their work performances, they play an active part in relevant processes related to quality and they make the communication productive and efficient.

2.2. CUSTOMERS: Meeting the requirements of Customer and increasing the customer satisfaction.

2.3. SUPPLIERS: Quality, Shipment and Service performances of our Suppliers are evaluated and developed



"Sıfır Hatalı Parça Üretimi" ve "Tek Seferde Hatasız Üretim" hedefine ulaşmaya çalışılır.

2.5. KALİTE YÖNETİM SİSTEMİ VE STANDARTLARI: ISO 9001-2008 kalite yönetim sistemi, ISO 14001-2004 çevre yönetim sistemi ve CE belgesi ve müşteri özel isteklerine tam uyumluluk.

Çalışanlar, müşteriler ve son kullanıcılar nezdinde ürün emniyeti vaz geçilemeyecek bir gerekliliktir. Uygunluk, verimlilik ve etkinlik parametrelerinin ışığı altında kalite yönetim sistemi üst yönetim tarafından periyodik olarak gözden geçirilir ve gerekli görüldüğü takdirde uygun düzeltmeler ve eklemler yapılmaları için aksiyonlar başlatılır.



within the scope of continuous improvement.

2.4. PROCESSES: All efforts are made for achieving the goal stated as "Zero-Error Spare Part Production" and "Error-Free Production at once" by developing continuous productivity of processes according to firm's goals and Customer satisfaction.

2.5. QUALITY MANAGEMENT SYSTEMS AND STANDARDS: Full-compatible with ISO 9001-2008 Quality Management System, ISO 14001-2004, Environmental Management System, CE Certificate and Special Requirements of Customer.

Product security refers to a critical necessity for Employees, Customers and End-Users. Quality Management System is subject to periodical surveillance carried out by Senior Management in the light of Compatibility, Productivity and Efficiency parameters and actions are taken to make appropriate amendments and additions if appropriate.

İŞ GÜVENLİĞİ, SAĞLIK VE EMNİYET POLİTİKASI / WORK SAFETY, HEALTH AND SECURITY POLICY

Soylu Ltd. müşterilerine ve topluma hizmet verirken kalite, çevre, güvenlik, sağlık şartlarına uygun olarak çalışmayı ve buna bağlı yasal mevzuata riayet etmeyi şirket prensibi olarak kabul etmiştir.

Birinci önceliğimiz hataları meydana gelmeden önlemektir; bunu kurmuş olduğumuz etkin sürekli iyileştirme, önleme ve düzeltme sistemi ile gerçekleştiririz.

When providing services for its customers and society, Soylu Ltd. accepts to work in compliance with quality, environment, security and health conditions and requirements and follow the legal regulation with respect to this as a company principle.

Our first priority is to prevent the occurrence of any mistake; we make this happen through an established, efficient and

Hizmetlerimizi yerine getirirken, müşterilerimizin bize emanet ettikleri ürün, ekipman ve bilginin yüksek değerinin bilincinde hareket ederek, bunların güvenliği ve bütünlüğünü korumak için gerekli tüm önlemleri almayı taahhüt ederiz.

Benzer şekilde, hizmetimizin kalite ve güvenliğini sürdürmek için şirket varlığımızı da suistimalden ve zarardan korumayı öncelikli görevlerimiz arasında kabul ediyoruz.

Bu prensipler çerçevesinde sorumlu olduğumuz tarafların kalite, çevre, güvenlik ve sağlık

continuous improvement, avoidance and correction system.

When providing our services, we hereby guarantee to take all necessary precautions in order to protect safety and entirety of all products, equipments and information consigned to us by our customers by acting with the consciousness of high value of such information.

Accordingly, we hereby accept to protect our corporate assets from any misuse and damage as an essential duty with the purpose of maintaining

ile ilgili beklentilerini karşılamak; bunu yaparken de bizden kaynaklanan çevre etkilerini en düşük seviyeye indirmek ve kaynaklarımızı etkin kullanarak gelecek nesillere daha iyi bir ekolojik çevre bırakmak amaç ve hedeflerimiz arasındadır.

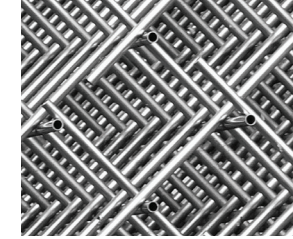

the quality and safety of our services.

Within the frame of such principles; issues such as meeting the expectations related to environment, safety and health of parties for whom we are responsible; minimalising the environmental effects arising from our intervention when carrying out this and providing more ecological environment for future generations by using our resources effectively are available amount our goals and purposes.



AR-GE / R&D

Ar-Ge Merkezi'nde yapılan geliştirme faaliyetleri ile OEM ve After Market müşterilerinin talep ettiği ürün süreci yönetilmektedir. Sürdürülebilir büyüme modeli stratejisi ile sürekli ileri teknolojiye yatırım yapan Soylu Ltd. Ar-Ge Merkezi; tasarım, test ve analiz imkanları ile inovatif ürünler ortaya çıkarmaktadır. Proje bazında ürün tasarım kabiliyeti ile ön plana çıkan Soylu Ltd. Ar-Ge Merkezi, fikri ve sınai

The priority of Soylu Exhaust Systems is the high quality and eco-friendly production which is better than the other competitors. Soylu, that volume-produces in the light of this information, is a company that produces sheet metal parts, air intake pipes, chassis pipes, radiator pipes and water pipes beside the exhaust equipment and has already proved its quality to the whole world with the qualified labour force. And

mülkiyet hakları Soylu Ltd.'e ait olan ve Ar-Ge kapsamında geliştirilen patentli ürünler ve endüstriyel tasarımlar ortaya çıkarmaktadır.

Yenilikçi ve sürdürülebilir bir anlayışa sahip olan Soylu Ltd. genç ve dinamik AR-GE ekibi, ileri Teknolojiye yönelik araştırma ve tasarımları ile farkımızı ortaya koymaktadır.

provides the production with strict quality control standards at the every stage of production.

The prototypes of the products are prepared as agreeably to the strict quality control and standards by R&D department.

Soylu Exhaust Systems that has a muffler production capacity ranging between Ø89 mm - Ø905 mm and 55 different types of scale; reduces the need for resources with the silencer body clamps it develops and maximizes the product performance.

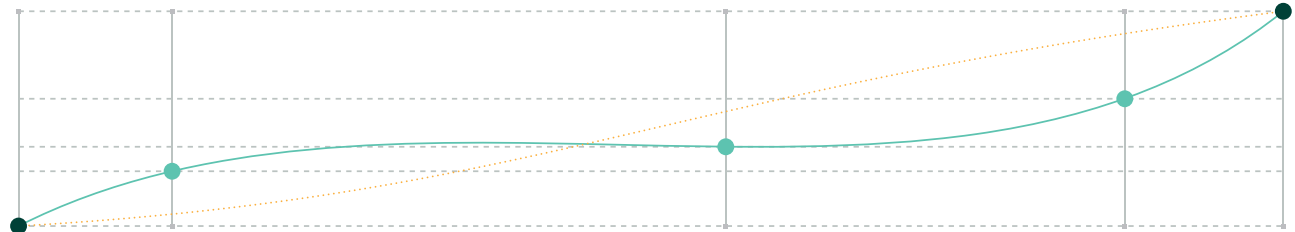

**GARANTİ UYGULAMALARI /
GUARANTEE APPLICATIONS**

Müşteri memnuniyeti ve toplam kalite yönetimini temel ilke olarak benimseyen Soylu Ltd. satış sonrası hizmet kalitesini de bu temel ilkeler doğrultusunda geliştirmektedir.

Soylu Ltd. ürünlerinde garanti süresi; malın müşteriye satış tarihinden itibaren başlar ve 2 yıl sürer.

Customer satisfaction and total quality management as a basic principle, adopting the quality of after sales service Soylu Ltd. that are developing in line with the basic principles.

Soylu Ltd. products warranty period; from the date of sale to the customer of the goods begins and lasts for 2 years.

Malın bütün parçaları dahil olmak üzere tamamı firmamızın garantisini kapsamaktadır. Garanti talebinin kabul edilebilmesi için, parçanın arıza yaptığı tarihin garanti döneminin içerisinde olması esastır.

Ürününüzle birlikte almanız gereken garanti belgenizin, ürünün garanti kapsamında değiştirilebilmesi veya arızanın giderilebilmesi için mutlak ibrazı gereklidir.

All goods are covered by our guarantee all parts including.

Warranty claim is to be considered, it is essential to have in his history of the warranty period of breakdown.

If you need warranty document that came with the product, the product can be exchanged under warranty or failure about the absolute submission is required.



SERTİFİKALAR / CERTIFICATES



TS EN ISO 14001 - 2004 Çevre Yönetim Sistemi



ISO 9001- 2008 Kalite Yönetim Sistemi



CE Belgesi - EEC 70/157 Standartları



SOYLU / OTOBÜS

AYATS

Bravo

11

Series BRAVO

Type

Euro III
35/01 →



MANA 34 chassis

D2866 LUH
12,0l tr.
6 cyl.
228 KW/310 HP
265 KW/360 HP

Front pipe

14765
81.15205.5089



10379
81.15204.5090

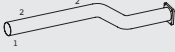

Silencer

10581
81.15101.0356



Tail pipe

10363
81.15205.5091



Mounting Parts

1.
00971
81.97420.0152



2.
00981
81.97420.2017



3.
10082
81.97460.5245



4.
10431
81.97488.0534



5.
10454
81.96210.0101



Horizontal
LHD/RHD
Standard

SOYLU / OTOBÜS

BOVA



Europa 13

Futura 14

Series EUROPA

Type

Euro I



DHU 825
8,3l tr.
6 cyl.
169 KW/230 HP

Front pipeT

Silencer

ail pipe

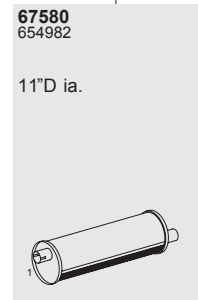
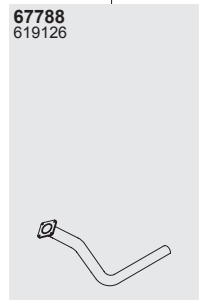
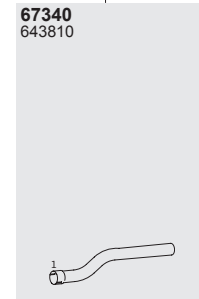
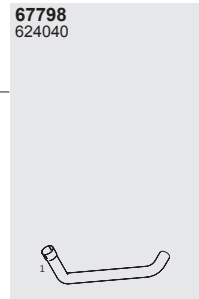
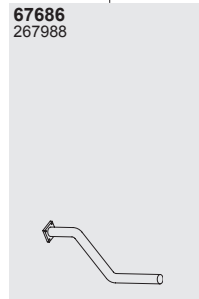

Mounting Parts

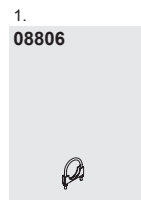

Horizontal
LHD
Standard

Series FUTURA

Type



DKV 1160
11,6 ltr.
6 cyl.
211K W/280 HP

DKT 1160
11,6 ltr.
6 cyl.
213 KW/290 HP

Front pipe

Silencer

Tail pipe

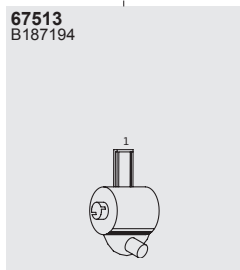
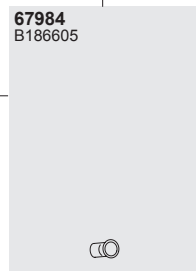
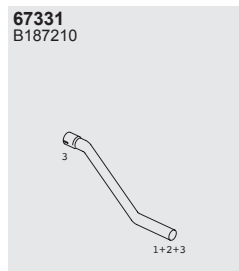
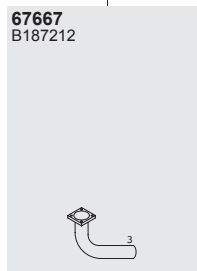

Mounting Parts

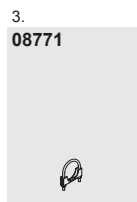
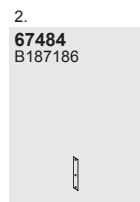
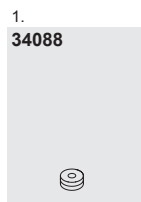

Horizontal
LHD
Standard

Series FUTURA

Type



DKV 1160
11,6 ltr.
6 cyl.
211K W/280 HP

DKT 1160
11,6 ltr.
6 cyl.
213 KW/290 HP

Front pipeT

67668
B185920



Silencer

67533
▶CHno 3181



67595
B185949

3181 ▶CHno



ail pipe

67984
B186605



Mounting Parts

1.
34088



2.
00671



3.
08771



Horizontal
LHD
Standard

Series FUTURA

Type

Euro II
1994 →



FHD

DAF Engine
11,6 ltr.
6 cyl.
250 KW/340 HP
272 KW/370 HP
315 KW/430 HP

Front pipeT

67684
B219270



Silencer

67534
B214072
B219740

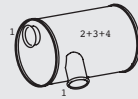

ail pipe

67985
B219277



Mounting Parts

1.
67453
B219843



2.
67459
B219274



3.
67454
B219278



4.
67466
285530



5.
67418
B185953



6.
67417
B214311



7.
67416
B219809



Horizontal
LHD
Standard

Series FUTURA

Type

Euro II
1994 →



④X②
⑥X②

FHD

DAF Engine
11,6 ltr.
6 cyl.
250 KW/340 HP
272 KW/370 HP
315 KW/430 HP

Front pipeT

67669
B212127

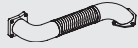

Silencer

67555
555004

TÜV/KBA 21194

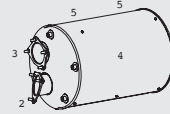

ail pipe

67977
B212141



67976
B212143



Mounting Parts

1.

08768
682608
279634
279633



2.

67087
1248140
375044



3.

67085
1248143
555011



4.

67472
373316



5.

67468
221342



Horizontal
LHD
Standard

Series FUTURA

Type

Euro II
1994 →



FHX

MAN
FHX15-370
12,0l tr.
6 cyl.
272 KW/370 HP

Horizontal
LHD
Standard

Front pipeT

67683
B214028

N.A.
B214002

Silencer

67534
B214072
B219740

ail pipe

N.A.
B208955

Mounting Parts

1.
67453
B219843

2.
67459
B219274

3.
67454
B219278

4.
67466
285530

Series FUTURA

Type

Euro II
1994 →



FLC

CUMMINS
11,6 ltr.
6 cyl.
278 KW/378 HP

Front pipeT Silencer ail pipe

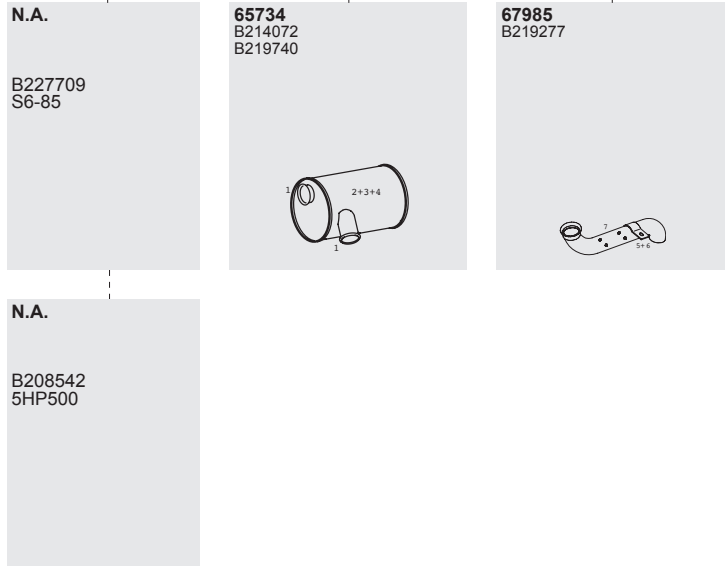

Mounting Parts

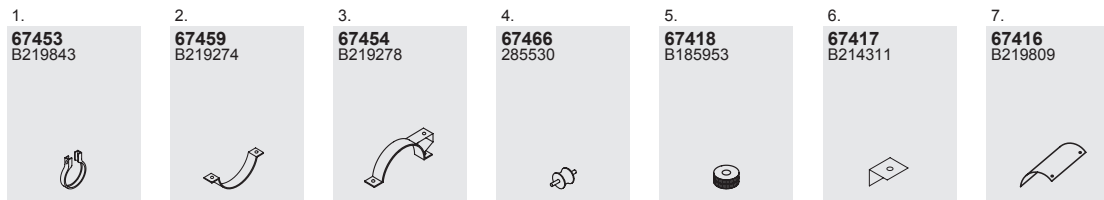

Horizontal
LHD
Standard

Series FUTURA

Type

Euro II
1994 →



FLD

DAF XE340C
13,0l tr.
6 cyl.
256 KW/340 HP

Front pipeT

Silencer

ail pipe

67680
B208114



67678
B208109



67534
B214072
B219740

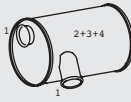

67985
B219277



Mounting Parts

1.

67453
B219843



2.

67459
B219274



3.

67454
B219278



4.

67466
285530



5.

67418
B185953



6.

67417
B214311



7.

67416
B219809



Horizontal
LHD
Standard

Series FUTURA

Type

Euro III
09/01 →



FHD

DAF RS 200 M
8,7l tr.
6 cyl.
200 KW/270 HP

DAF RS 222 M
8,7l tr.
6 cyl.
222 KW/302 HP

DAF RS 245 M
8,7l tr.
6 cyl.
245 KW/333 HP

Silencer

Tail pipe

67531
B 226 899

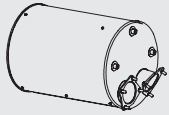

62287
B 226 925
20 226 925



62987
B 226 927
20 226 927



Mounting Parts

1.
67085
1248143
555011



2.
08768
682608
279634
279633



Horizontal
LHD/RHD
Standard

SOYLU / OTOBÜS

BREDAMENARINI

M 230

23

M 321

24



Series M 230

Type



M 230

Front pipe

60747
D016893



60790
D017531

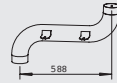

60799
D016887



60793
D016886



60746
0076696



60748
D017529



Silencer

64562
D000601

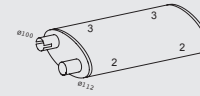

Tail pipe

64921
D016890



Mounting Parts

1.
00981
0179551



2.
64442
D000809



3.
64443
D000807



4.
00971
0179544



Horizontal
LHD
Standard

Series M 321

Type



④ X ②
⑥ X ②

M 321

Front pipe

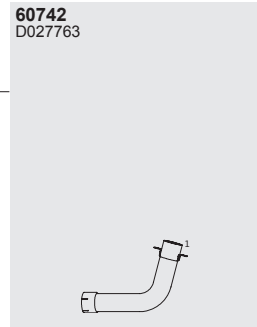
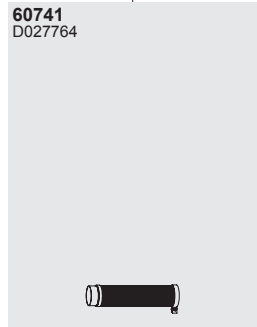

Silencer

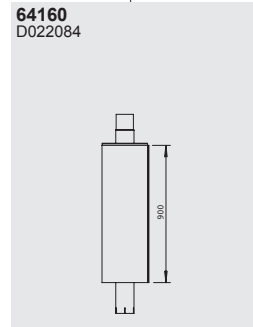

Mounting Parts

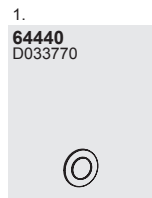

Horizontal
LHD
Standard

SOYLU / OTOBÜS

DAF

DB 250	26
SB 120	27
SB 200	28
SB 220	29
SB 2005	30
SB 2300	31
B 3000	32



Series DB250

Type

Euro II



4X2

Spectra

Front pipe

Silencer

Tail pipe

67740
1245025



67535
1207495



67304
1241648



Mounting Parts

1.
67479
1232410



2.
67466
B210027
0285530
651183



3.
08780
682605
377937



4.
10476
0740737
1328104



Horizontal
LHD
Standard

Series SB120

Type

Euro III
1999 →



CUMMINS
ISBE
5,9l tr.
4 cyl.
110K W/150 HP
136 KW/185 HP
162 KW/220 HP

Front pipe

66733
1145507

Insulation



66739
1155077
1145624
1150330



Silencer

67150
1145502

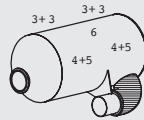

Tail pipe

67942
1145510
1147336



Mounting Parts

1.
00381
1337543



2.
17455
1136486



3.
11488
0487257
1146166



4.
02184
1150196



5.
04408
1145623



6.
67405
1145508



7.
67440
1147024



8.
08802
1146157



Horizontal
LHD/RHD
Standard

Series SB200

Type

Euro III
2001 →



CUMMINS
ISBE
5,9l tr.
4 cyl.
110K W/150 HP
136 KW/185 HP
162 KW/220 HP

Front pipe

66731
1147405

Insulation



66732
1155076



Silencer

67150
1145502

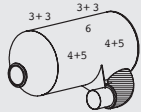

Tail pipe

67943
1146556

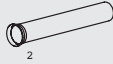

Mounting Parts

1.
00381
1337543



2.
17455
1136486



3.
11488
0487257
1146166



4.
02184
1150196



5.
04408
1145623



6.
67401
1146571



Horizontal
LHD/RHD
Standard

Series SB220

Type

Euro II



DeltaB ody
Icarus Body

Front pipe

Silencer

Tail pipe

67660
0083162



67510
386296
1726436

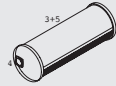

67738
388007

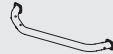

67528
387500

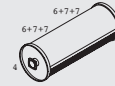

67393
388009



Mounting Parts

1.
08282
682606



2.
00381
1337543



3.
67464
0298390
298390



4.
67086
274809



5.
67480
297614



6.
67478
271589



7.
67466
B210027
0285530
651183



8.
10476
0740737
1328104



Horizontal
LHD
Standard

Series SB2005

Type

Euro II



4X2

Front pipe



Silencer



Mounting Parts



Horizontal
LHD
Standard

Series SB2300

Type

Euro II



4X2

Rear Engine

Front pipe

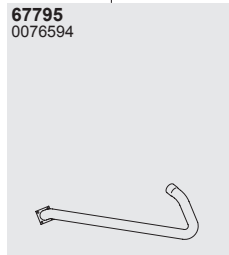

Silencer

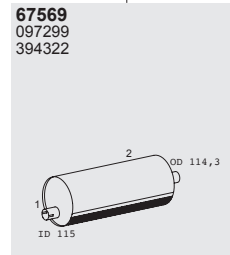

Tail pipe

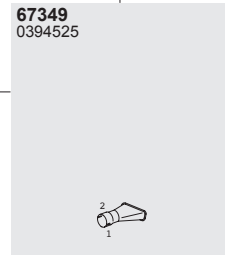
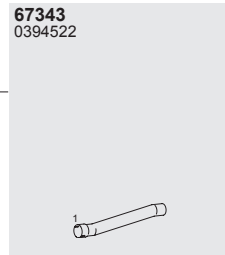

Mounting Parts

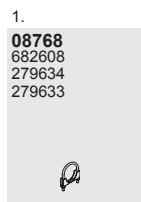

Horizontal
LHD
Standard

Series SB3000

Type

Euro II



4X2

Rear Engine

Front pipe

Silencer

Tail pipe

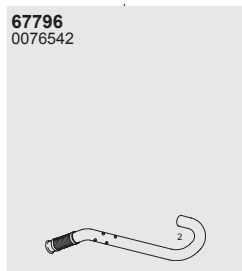
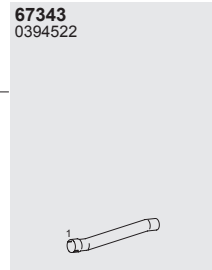
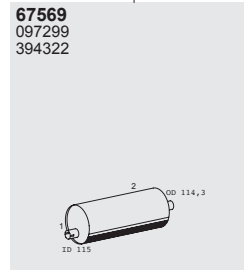
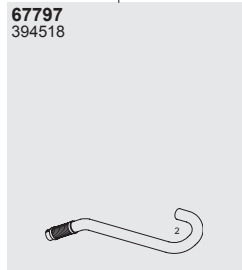

Mounting Parts

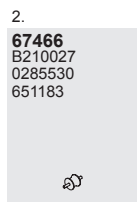

Horizontal
LHD
Standard

SOYLU / OTOBÜS

DRÖGMÖLLER

E 330 H

34

Series E330H

Type

Euro I



E330H

Front pipe

Silencer

Tail pipe

27762
834.100.0254
621.490.0065



27763
621.492.0008



26693
618.492.0201
356.492.1501



28151
356.490.0001

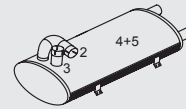

26937
613.490.0021
356.490.0221
356.490.0121



27762
834.100.0254
621.490.0065



27763
621.492.0008



26937
613.490.0021
356.490.0221
356.490.0121



Mounting Parts

1.
28410
621.997.0090



2.
28073
625.492.0040



3.
00901
071.555.094.502



4.
28480
381.492.0082
301.492.0382
0201.175.00



5. Kit
28007



Horizontal
LHD
Standard

SOYLU / OTOBÜS

IVECO



370SE.27

36

New Daily

44

Cityclass

37

Daily III

48

Daily

38

Euroclass

50

Daily 96

41

Eurorider

51

Daily City Truck

42

Turbocity

52

Series 370SE.27

Type

Euro I



370SE.27

Front pipe

60750
93197952



60751
4866342



60752
93197953



Silencer

64176
4772912

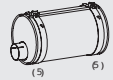

Tail pipe

64911
93197954

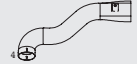

Mounting Parts

1.
28061
4839514



2.
28069
4819971



3.
64424
2483398
4808624
0.248.3398



4.
64423
61605919
4831522



5.
64421
4776740



Horizontal
LHD
Standard

Series CITYCLASS

Type

Euro III



491.22
491.27
591.22
591.27

WB 5150, 6050

Front pipe

Silencer

Tail pipe

60753
99450909

64177
99438706

N.A.
99467231

64918
99440614

64917
99467298

64916
4866341

64915
99440618

60754
99471461
500342807

60759
99440594

Mounting Parts

1.
64424
2483398
4808624
0.248.3398

2.
28012
61597491
8572665
61597791

3.
64423
61605919
4831522

4.
64422
99467729

5.
64426
99482279

6.
64411
41015925
42092142

7.
64489
98456735

Horizontal
LHD
Standard

Series DAILY

Type



4X2

Turbo
Restyling

LHD
35.10
49.10 [Ⓧ]

RHD
35.10
45.10
49.10

Horizontal
LHD/RHD
Standard

Front pipeT

64622
93814191
93809314

Silencer

64553
93822262
93809509
93809799

ail pipe

64333
93810561

64339
93811172

RHD

64334
93825417
8585475

RHD

Mounting Parts

1.
64478
8585923

2.
64477
8582510

3.
64087
93818454
93809649
93806171

4.
64476
93806116

5.
64475
8586089

Series DAILY

Type



4X2

Restyling

30.8(Heavy duty)
35.8
40.8

Horizontal
LHD
Standard

Front pipeT

64788
93803466

Silencer

64588
93806921
93801800
8581937

ail pipe

64370
93806153

1983 → 1990

64388
93804204
93802875

→ 1982

64342
93806155

Mounting Parts

1.
00827
93804147

2.
64087
93818454
93809649
93806171

3.
64476
93806116

Series DAILY

Type



Turbo
Restyling

35.10
40.10
45.10
49.10

Horizontal
LHD
Standard

Front pipeT

Silencer

ail pipe

64757
8582280

Standard

64575
8588810
8585093

64367
8587425

WB 2800, 3200, 3600

64617
60135813

40.10

64368
8587428

WB 3950

64341
8587660

49.10

64334
93825417
8585475

49.10

64339
93811172

49.10

Mounting Parts

1.
64478
8585923

2.
64477
8582510

3.
64087
93818454
93809649
93806171

4.
64476
93806116

5.
64475
8586089

Series DAILY 96

Type

Euro 2
1996 →



④X②
④X④

30.8
35.8

Turbo
30.10
35.10
40.10
49.10

Turbo/intercooler
35.12
49.12
59.12

Front pipe

64693
93822952

LHD
Incl.C AT
30.10, 35.10, 49.10, 35.12,
49.12, 59.12

64699
93822671

LHD
30.8, 30.10, 35.10, 49.10,
35.12, 49.12, 59.12

64694
93822954

Interp pipe
Used with CAT

64649
93822859

30.8, 35.8

64642
93822719

RHD
30.8, 30.10, 35.10, 49.10,
35.12, 49.12, 59.12

64641
93825397

④X④
40.10

64643
93822953

RHD
Incl.C AT
30.10, 35.10, 49.10, 35.12,
49.12, 59.12

Silencer

64553
93822262
93809509
93809799
Turbo

64516
93822669
93809798
93811160
▶CHno 2088423

Tail pipe

06831
93821950

64983
93811990

LHD
59.12

64984
93811173

RHD

64333
93810561

LHD
30.8, 35.8, 30.10, 35.10, 49.10,
35.12, 49.12, 59.12

64952
93809770

LHD- 59.12
RHD

Mounting Parts

1.
64475
8586089

2.
64478
8585923

3.
64087
93818454
93809649
93806171

4.
64477
8582510

5. Kit
18829

6. CAT retrofit
18573

Horizontal
LHD/RHD
Standard

Series DAILY CITY TRUCK

Type

Euro 3



④X②
④X④

29L10
29L12
35S9
35S10
35S11
35S12
35S13
35S15
35C9
35C10
35C11
35C12
35C13
35C15
50C11
50C13
50C15
65C13
65C15



④X②
④X④

40C13
40C15
50C11
50C13
50C15

Front pipe

60659
500329487
504033946

29L10, 29L12
35C9, 35C10, 35C11, 35C12, 35C13, 35C15
35S9, 35S10, 35S11, 35S12, 35S13, 35S15
50C11, 50C13, 50C15
65C13, 65C15

40C13, 40C15
50C11, 50C13, 50C15

60650
500329481
504033945
504098008

35C11, 35S11
50C11

35C13, 35S11, 35S13
50C11
CAT

60654
500329488

, WB 3000/3450/3750
35S9
WB 3000/3450/3750/4100
35C9
 , WB 3000/3300/3950
35C9, 35S9
CAT

Silencer

64184
500329489
500329483

Mounting Parts

1.
33814
9603895480

2.
60482
500329485

3.
64478
8585923

Page 1/2
Next page:
(syst. 228000009)

Horizontal
LHD/RHD
Standard

Series DAILY CITY TRUCK

Type

Euro 3



④X②
④X④

29L10
29L12
35S9
35S10
35S11
35S12
35S13
35S15
35C9
35C10
35C11
35C12
35C13
35C15
50C11
50C13
50C15
65C13
65C15



④X②
④X④

40C13
40C15
50C11
50C13
50C15

Page 2/2
Previous page:
(syst. 228000008)

Horizontal
LHD/RHD
Standard

Silencer

Tail pipe

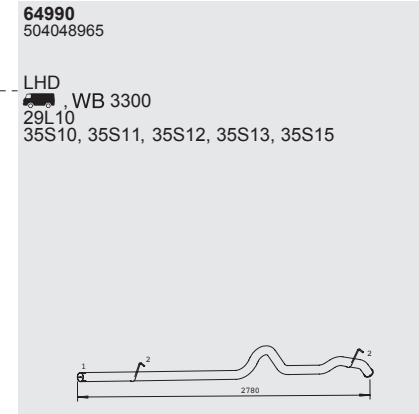
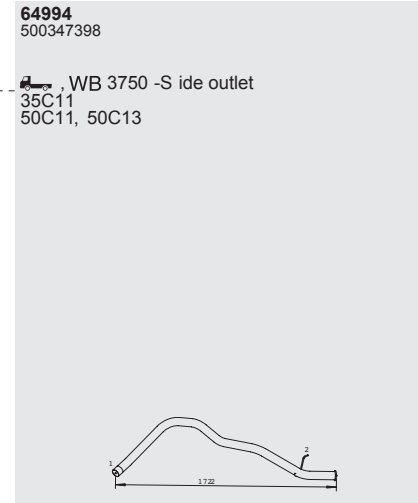
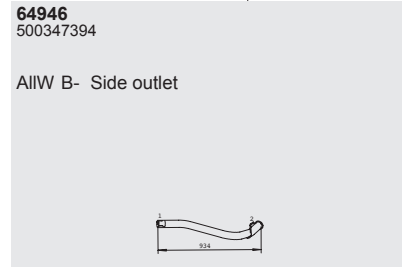
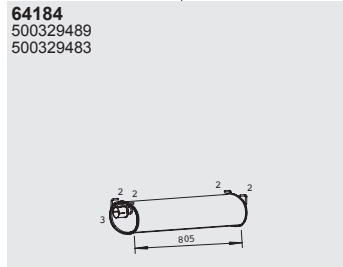

Mounting Parts

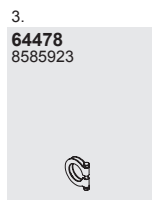
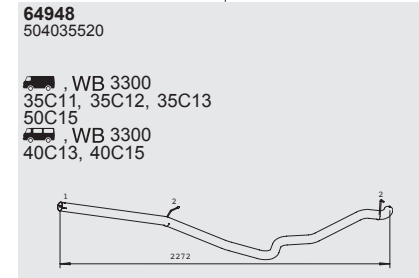
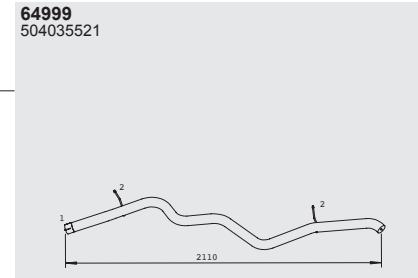
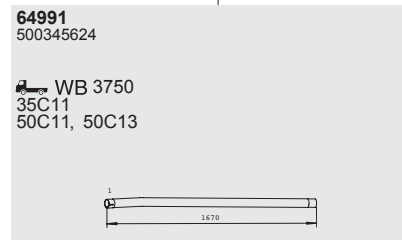
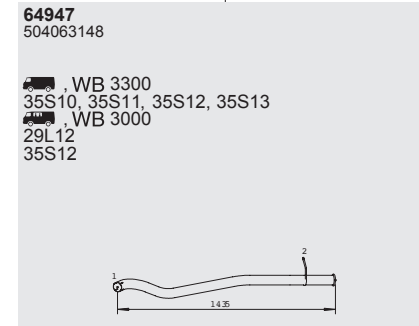
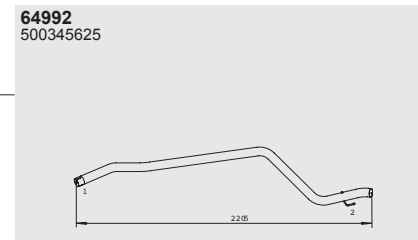
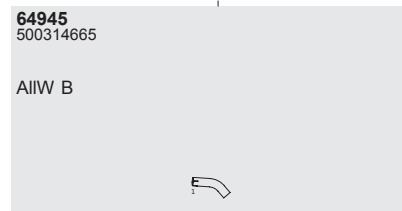
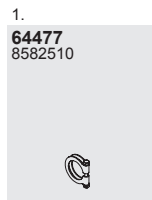

Series NEW DAILY

Type

Euro 1
1990 → 1995



Nont urbo
30.8
35.8
40.8

Front pipeT

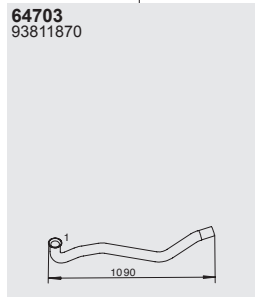
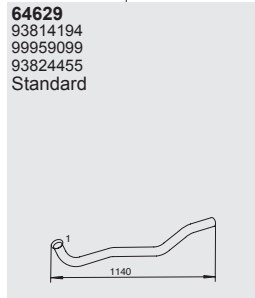

Silencer

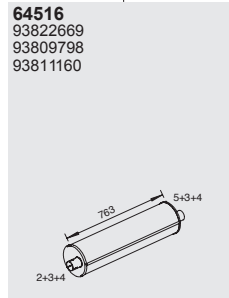

ail pipe

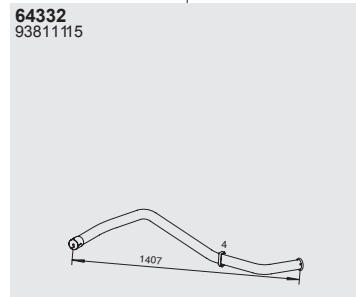
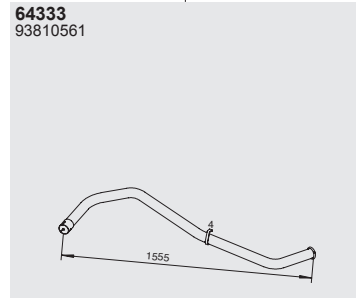

Mounting Parts

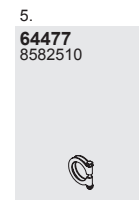
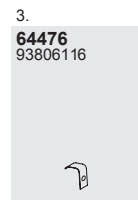
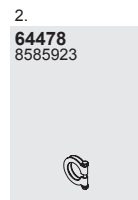
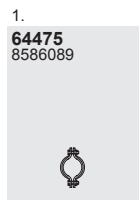

Horizontal
LHD/RHD
Standard

Series NEW DAILY

Type

Euro 1
1990 → 1995



Turbo
35.10
45.10
49.10

Turbo/intercooler
35.12
49.12
59.12

Horizontal
LHD/RHD
Standard

Front pipe

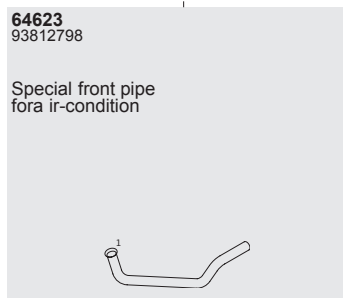
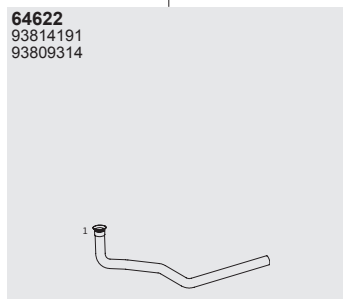

Silencer

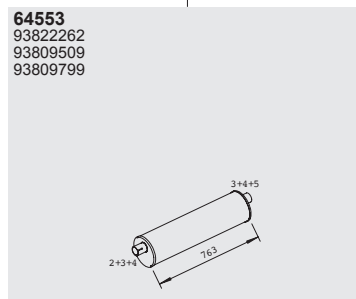

Tail pipe

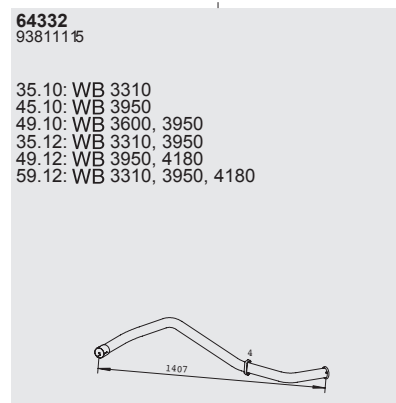
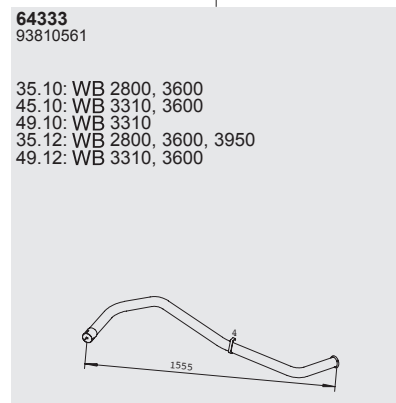

Mounting Parts

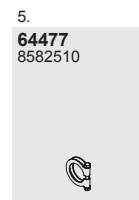
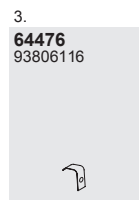
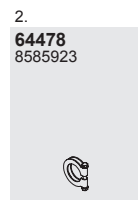
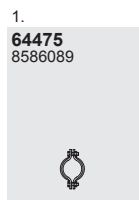

Series NEW DAILY

Type

Euro 1
1990 → 1995



Turbo
35.10
49.10

Turbo/intercooler
35.12
49.12
59.12

Front pipeT

Silencer

ail pipe

64623
93812798

Fora ir-condition

64553
93822262
93809509
93809799

64983
93811990

35.10, 35.12, 49.10, 49.12, 59.12: WB 3600

64977
93814429

49.12, 59.12: WB 4180.

64622
93814191
93809314

64984
93811173

35.12: WB 3310, 3950

64976
93814989

49.12, 59.12: WB 4180.

Mounting Parts

1.
64475
8586089

2.
64478
8585923

3.
64476
93806116

4.
64087
93818454
93809649
93806171

5.
64477
8582510

64334
93825417
8585475

35.10, WB 3310

64980
93808127

35.12: WB 3310. 35.12: WB 3950

64339
93811172

64989
93814586

35.10, 35.12, 49.10, 49.12, 59.12: WB 3600

Horizontal
LHD/RHD
Standard

Series NEW DAILY

Type

Euro 1
1990 → 1995



Turbo
35.10
WB 3310

Front pipeT

Silencer

ail pipe

64623
93812798

Fora ir-condition

64553
93822262
93809509
93809799

64339
93811172

64334
93825417
8585475

64622
93814191
93809314

Mounting Parts

1.
64475
8586089

2.
64478
8585923

3.
64476
93806116

4.
64087
93818454
93809649
93806171

5.
64477
8582510

Horizontal
LHD
Standard

Series DAILY III

Type

Euro 4
05/2006 →



29L12
29L14
35C18
35S12
35S14
50C15
50C18



35C10
35C15
35C12
35S18
40C15
40C18
40C12



29L10
35S10



50C15BUS
50C18BUS



35C14



35S10



F1AE0481
2,3l tr.
4 cyl.
70 KW/95H P
85 KW/116 HP
100 KW/136 HP

F1C10481
3,0l tr.
4 cyl.
107 KW/146 HP
130 KW/176 HP

Horizontal
LHD
Standard

Front pipe

Silencer

Tail pipe

60608
504141540



64513
504141541

Excl.:
35C18, 35S18, 40C18, 50C18

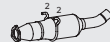

64511
504141545

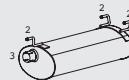

64945
500314665

Excl.:
35S14, 35C14, 35C18
35S10, 40C15, WB 3750
50C15BUS, 50C18BUS



64947
504063148

35S14, WB 3000



64519
504141542

35C15, 35C18, 35S18,
40C18, 50C18



64380
504197227
500347392

50C18, WB 3950
35C14, 35C18, WB 3950
(CAMPER) 35C18 WB
3750, 3950
35C18, WB 3950
▶CHno 5345677/5375347

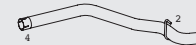

64993
500345628

WB 3950
50C15BUS, 50C18BUS

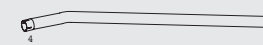

Mounting Parts

1.
55471
9603895480



2.
60482
500329485



3.
64478
8585923



4.
64477
8582510



Series DAILY III

Type

Euro 4
05/2006 →



50C15
65C18

40C15
40C18
65C14
65C15

50C18

35C15
35C18

35S18
35S18W

F1CE0481
3,0l tr.
4 cyl.
107 KW/146 HP
130 KW/176 HP

Horizontal
LHD
Standard

Front pipe

60603
504161873



64512
504131264

CAT/DPF

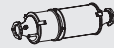

Silencer

64552
504131265

Round
Incl. heatshield

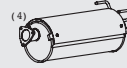

Tail pipe

64993
500345628

WB 3950
50C15, 50C18
50C15

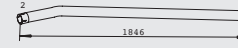

64991
500345624

WB 3750
50C15
50C18

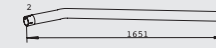

64380
504197227
500347392

(CAMPER)
35C18, WB 3950

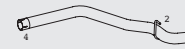

64378
500347393

65C14, WB 4350



64999
504035521

50C15, 50C18
WB 3950
5362114 ▶CHno



60374
504041806

35C15, 35C18, 35S18, 35S18W,
40C15, 40C18, 65C14, 65C15, 65C18
Excl. 50C15, WB 3750
Excl. 65C14, WB 4350



Mounting Parts

1.
55471
9603895480



2.
64477
8582510



3.
60482
500329485



4. Used for 35S18W
60285
504239913



Series EUROCLASS

Type

Euro I



EuroClass 29
EuroClass 35
EuroClass HD

WB 5520, 6210

Front pipe

Silencer

Tail pipe

64604
93196795

64600
98495744

64178
99432294

64950
98495746



Mounting Parts

1.
64433
42075780
42094001

2.
64432
42075779
42090154

3.
00968

4.
64427
99448202



Horizontal
LHD
Standard

Series EURORIDER

Type

Euro I



EuroRider 29 A
EuroRider 35

WB 6150

Front pipe

60623
99469078
99435647



60629
99435656



60624
99469081
99435661



Silencer

64116
42092438
500306919

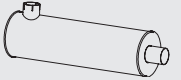

Tail pipe

64940
99435689



Mounting Parts

1.
08771
99435657



2.
00971
41800522
41801045
42073330



Horizontal
LHD/RHD
Standard

Series TURBOCITY

Type

Euro I



4X2

TurboCity 480

WB 5110

Front pipe

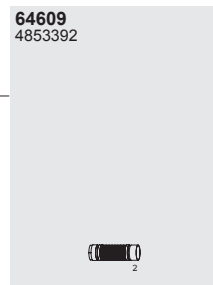
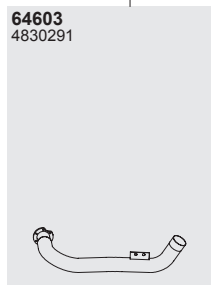

Silencer

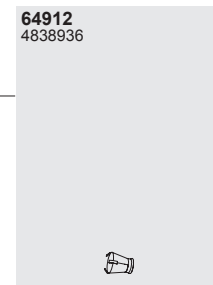

Tail pipe

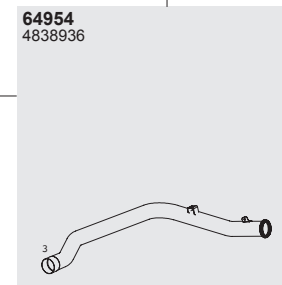

Mounting Parts

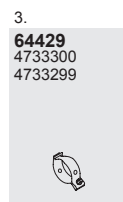

Horizontal
LHD
Standard

MAN

1

10.150	56	16.280	74
10.180	57	16.290	77
10.190	58	16.360	79
11.150	60	16.372	83
11.180	61	18.220	85
11.190	62	18.220/230/250	89
12.220 HOCL/R-NL	64	18.220/280	92
13.210/220/230 HOCL/R	66	18.260/410/460 HOCL/R	93
13.230	67	18.310/350/370/400/420/460 HOCL/R	94
14.220	68	18.310/350/370/400/420 HOCL/R LBC	95
16.240	73	18.310/350/370/400/420 HOCL/R-SDK	96

MAN

2

18.310/370/470	97	LION'S CITY	111
19.290	98	LION'S CITY DD	120
22.330	99	LION'S CITY G	122
22.360	100	LION'S CITY M	124
24.350/400 HOCLN	102	LION'S CITY T	126
24.400/460 HOCLN/R-CKD	103	LION'S CITY/ LION'S CITY UE	127
290	104	LION'S CITY UE	131
292	105	LION'S CITY/ LION'S CITY UE/G/UELL/LL	136
292/332/362 H	106	LION'S CLASSIC G	144
322/352/402/422/462 FRH	108	LION'S CITY T	145
EL 202	110	LION'S CLASSIC UE	146

MAN

3

LION'S COACH	149	SG 242	162
LION'S STAR	150	SG 292	164
ND 202	151	SL 202	165
ND 242/272	153	SL 18.220/260/280 HOLCL/R	167
ND 263/313 F	154	SR 280	168
NM 152	155	SUE 242	169
NL 202	156	SUE 280	170
NL 202/222/272/312	157	UEL 242/272/292	171
NL 223/263/313 F	158	UEL 313/353	173
RUE 280	161		

Series 10.150

Type

32/87 →



④X②

469
10.150 HOCL/R

D0826 OH
7,0l tr
6 cyl.
110K W/150 HP

Silencer

10577
81.15101.0192
81.15101.0191

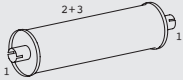

Tail pipe

10976
81.15204.0148

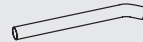

Mounting Parts

1.
00934
06.67042.0116
06.67049.0099



2.
10486
81.15501.5374
81.15501.5560



3.
10089
81.96210.0052



Horizontal
LHD
Standard

Series 10.180

Type

→ 15/90



④X②

469

10.180 HOCL/R

DO826 TOH

7,0l tr.

6 cyl.

132 KW/180 HP

Front pipe

17919
81.15204.0164



10634
81.15210.0056



19714
81.15204.5450
81.15204.0165



Silencer

10563
81.15101.0158
81.15101.0159

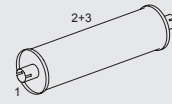

Tail pipe

10975
81.15204.0095



Mounting Parts

1.

00942
06.67041.0121
81.97420.0023
06.67041.0133



2.

10486
81.15501.5374
81.15501.5560



3.

10089
81.96210.0052



Horizontal
LHD
Standard

Series 10.190

Type

16/90 → 09/91



4X2

469

10.190 HOCL/R

16/90 → 09/91

DO826 TOH

7,0l tr.

6 cyl.

132 KW/180 HP

MAN

Front pipe

19719
81.15204.0164



10634
81.15210.0056



19714
81.15204.5450
81.15204.0165



Silencer

10563
81.15101.0158
81.15101.0159

→ 23/90

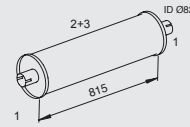

10555
81.15101.0229

24/90 → 09/91

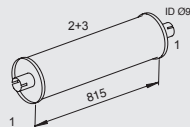

Tail pipe

10975
81.15204.0095

→ 23/90



10972
81.15204.0177

24/90 → 09/91



Mounting Parts

1.
00942
06.67041.0121
81.97420.0023
06.67041.0133



2.
10486
81.15501.5374
81.15501.5560



3.
10089
81.96210.0052



Horizontal
LHD
Standard

Series 10.190

Type

Euro I
10/91 →



469
10.190 HOCL/R

DO826 TOH
Vectra
7,0l tr.
6 cyl.
132 KW/180 HP
MAN

Front pipe

19710
81.15204.0174

10634
81.15210.0056

19728
81.15204.0176
→ 03/92

19727
81.15201.5065
81.15204.0213
04/92 →

Silencer

10534
81.15101.0251

10973
81.15204.0212
81.15204.0175

Tail pipe

N.A.
81.15205.5073

Mounting Parts

1.
00942
06.67041.0121
81.97420.0023
06.67041.0133

2.
00901
81.97420.0140
06.67041.0125
85.15640.0001

3.
10089
81.96210.0052

4.
10417
81.15502.5079
81.15501.6023
81.15502.5120

Horizontal
LHD
Standard

Series 11.150

Type

32/87 →



④X②

469
11.150 HOCL/R

D0826 OH
7,0l tr.
6 cyl.
110K W/150 HP

Silencer

10577
81.15101.0192
81.15101.0191

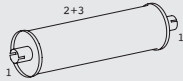

Tail pipe

10976
81.15204.0148



Mounting Parts

1.
00934
06.67042.0116
06.67049.0099



2.
10486
81.15501.5374
81.15501.5560



3.
10089
81.96210.0052



Horizontal
LHD
Standard

Series 11.180

Type

→ 15/90



4X2

469

11.180 HOCL/R

DO826 TOH

7,0l tr.

6 cyl.

132 KW/180 HP

Front pipe

19719
81.15204.0164



10634
81.15210.0056



19714
81.15204.5450
81.15204.0165



Silencer

10563
81.15101.0158
81.15101.0159

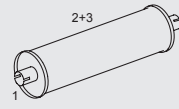

Tail pipe

10975
81.15204.0095



Mounting Parts

1.

00942
06.67041.0121
81.97420.0023
06.67041.0133



2.

10486
81.15501.5374
81.15501.5560



3.

10089
81.96210.0052



Horizontal
LHD
Standard

Series 11.190

Type

→ 09/91



4X2

469
11.190 HOCL/R

D0826 TOH
7,0l tr.
6 cyl.
132 KW/180 HP

Front pipe

19719
81.15204.0164



10643
81.15210.0056



19714
81.15204.5450
81.15204.0165



Silencer

10563
81.15101.0158
81.15101.0159

→ 23/90

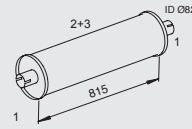

10555
81.15101.0229

24/90 → 09/91

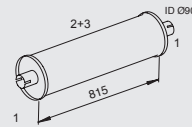

Tail pipe

10973
81.15204.0212
81.15204.0175

→ 23/90

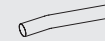

10972
81.15204.0177

24/90 → 09/91



Mounting Parts

1.
00942
06.67041.0121
81.97420.0023
06.67041.0133



2.
10486
81.15501.5374
81.15501.5560



3.
10089
81.96210.0052



Horizontal
LHD
Standard

Series 11.190

Type

Euro I
10/91 →



469
11.190 HOCL/R

D0826 TOH
7,0l tr.
6 cyl.
132 KW/180 HP

Front pipe

19710
81.15204.0174



10634
81.15210.0056



19728
81.15204.0176

→ 03/92



19727
81.15201.5065
81.15204.0213

04/92 →



Silencer

10534
81.15101.0251

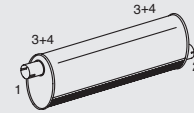

10973
81.15204.0212
81.15204.0175

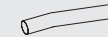

Tail pipe

N.A.
81.15205.5073

Mounting Parts

1.
00942
06.67041.0121
81.97420.0023
06.67041.0133



2.
00901
81.97420.0140
06.67041.0125
85.15640.0001



3.
10089
81.96210.0052



4.
10417
81.15502.5079
81.15501.6023
81.15502.5120



Horizontal
LHD
Standard

Series 12.220 HOCL/R-NL

Type

Euro III
15/99 →



A76

D0826 LOH
7,0l tr.
6 cyl.
162 KW/220 HP

Front pipe

19689
81.15204.5971



19777
81.15210.0022



19685
81.15204.0476



Silencer

19580
81.15101.0304

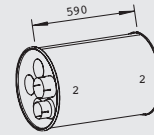

Tail pipe

19951
81.15204.0471

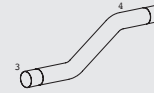

Mounting Parts

1.
00942
06.67041.0121
81.97420.0023
06.67041.0133



2.
10082
81.97460.5245



3.
00981
81.97420.2017
83.97420.0500



4.
00988
06.67041.0124
06.67043.0124
88.15640.0005



Horizontal
LHD/RHD
Standard

Series 12.220 HOCL/R-NL

Type

Euro III
15/99 →



A76

D0826 LOH
7,0l tr.
6 cyl.
162 KW/220 HP

Front pipe

19689
81.15204.5971



19777
81.15210.0022



19685
81.15204.0476



Silencer

19580
81.15101.0304

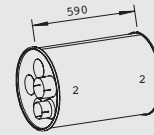

Tail pipe

19951
81.15204.0471

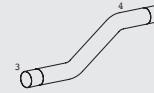

Mounting Parts

1.
00942
06.67041.0121
81.97420.0023
06.67041.0133



2.
10082
81.97460.5245



3.
00981
81.97420.2017
83.97420.0500



4.
00988
06.67041.0124
06.67043.0124
88.15640.0005



Horizontal
LHD/RHD
Standard

Series 13.210/220/230 HOCL/R

Type

Euro III
36/01 → 16/04



A53

D0826
LOH15/17/18/19
7,0l tr.
6 cyl.
155 KW/210 HP
162 KW/220 HP
169 KW/230 HP

Front pipe

19689
81.15204.5971



19777
81.15210.0022



19685
81.15204.0476



Silencer

19580
81.15101.0304

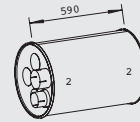

Tail pipe

19951
81.15204.0471



Mounting Parts

1.
00942
06.67041.0121
81.97420.0023
06.67041.0133



2.
10082
81.97460.5245



3.
00981
81.97420.2017
83.97420.0500



4.
00988
06.67041.0124
06.67043.0124
88.15640.0005



Horizontal
LHD/RHD
Standard

Series 13.230

Type

Euro III
36/01 → 16/04



A53
13.230 HOCL/R

D0826 LUH
7,0l tr.
6 cyl.
169 KW/230 HP

Front pipe

19689
81.15204.0278



19777
81.15210.0056



19685
81.15204.0274



Silencer

19580
81.15101.0251

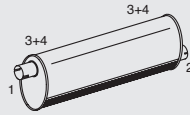

Tail pipe

19951
81.15204.0275



Mounting Parts

1.
00942
06.67041.0121
81.97420.0023
06.67041.0133



2.
10082
81.97420.0140
06.67041.0125
85.15640.0001



3.
00981
81.15502.5079
81.15501.6023
81.15502.5120



4.
00988
81.96210.0052



Horizontal
LHD
Standard

Series 14.220

Type

Euro III
01/98 →



A66
14.220

D0826
LOH03/15/19
7,0l tr.
6 cyl.
168 KW/220 HP

Auto

Front pipe

19687
81.15205.5035



19777
81.15210.0022



19680
83.94289.0529
83.15201.0502

→ 07/00



19685
81.15204.0476

07/00 →



Silencer

19580
81.15101.0304

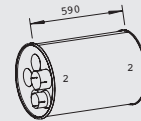

Tail pipe

19314
81.15204.0495

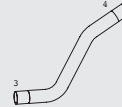

Mounting Parts

1.
00942
06.67041.0121
81.97420.0023
06.67041.0133



2.
10082
81.97460.5245



3.
00981
81.97420.2017
83.97420.0500



4.
00988
06.67041.0124
06.67043.0124
88.15640.0005



Horizontal
LHD
Standard

Series 14.220

Type

Euro II
01/98 →



A66
14.220

D0826 LUH
7,0l tr.
6 cyl.
162 KW/220 HP

Front pipe

10691
81.15204.0411
81.15204.5552



N.A.

81.15901.0033

19754
81.15204.0278



10634
81.15210.0056



19759
81.15204.0274



Silencer

10534
81.15101.0251

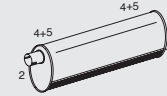

Tail pipe

19374
81.15204.0275



Mounting Parts

1.
10069
81.98112.0063



2.
00942
06.67041.0121
81.97420.0023
06.67041.0133



3.
00901
81.97420.0140
06.67041.0125
85.15640.0001



4.
10417
81.15502.5079
81.15501.6023
81.15502.5120



5.
10089
81.96210.0052



Horizontal
LHD
Standard

Series 14.220

Type

Euro III
01/98 →



A66
14.220

D0836 LOH03
7,0l tr.
6 cyl.
162 KW/220 HP

Auto

Front pipe

19687
81.15205.5035



19777
81.15210.0022



19685
81.15204.0476



Silencer

19564
81.15101.0317
81.15101.0302

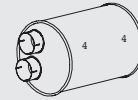

Tail pipe

19314
81.15204.0495

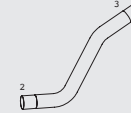

Mounting Parts

1.
00492
06.67041.0121
81.97420.0023
06.67041.0133



2.
00981
81.97420.2017
83.97420.0500



3.
00988
06.67041.0124
06.67043.0124
88.15640.0005



4.
10082
81.97460.5245



Horizontal
LHD
Standard

Series 14.220

Type

Euro III
01/98 →



A66
14.220

D0836 LOH03
7,0l tr.
6 cyl.
162 KW/220 HP

Auto

Front pipe

19682
81.15205.5007



19777
81.15210.0022



19685
81.15204.0476



Silencer

19580
81.15101.0304

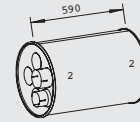

Tail pipe

19314
81.15204.0495

→ 01/02

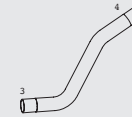

19328
81.15204.0509

01/02 →



Mounting Parts

1.
00942
06.67041.0121
81.97420.0023
06.67041.0133



2.
10082
81.97460.5245



3.
00981
81.97420.2017
83.97420.0500



4.
00988
06.67041.0124
06.67043.0124
88.15640.0005



Horizontal
LHD
Standard

Series 14.220

Type

Euro III
01/98 →



A66
14.220

D0826/36
7,0l tr.
6 cyl.
162 KW/220 HP

Auto

Front pipe

19682
81.15205.5007



19777
81.15210.0022



19683
81.15204.0489

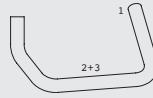

Silencer

19580
81.15101.0304

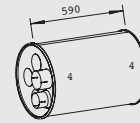

Tail pipe

19310
81.15204.0490

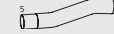

Mounting Parts

1.
00942
06.67041.0121
81.97420.0023
06.67041.0133



2.
67466
81.96210.0026



3.
00948
81.97420.0026
81.97420.0062



4.
10082
81.97460.5245



5.
00981
81.97420.2017
83.97420.0500



Horizontal
LHD
Standard

Series 16.240

Type

13/85 →



④X②

470
16.240 HOCL

471
16.240 HOC

D2866 OH
12,0l tr.
6 cyl.
177 KW /240 HP

Front pipe

10605
81.15204.5273



10601
81.15204.5272



Silencer

10566
81.15101.0153

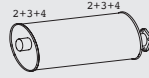

Tail pipe

10309
81.15202.5732



Mounting Parts

1.
00971
81.97420.0085
88.15640.2203
81.97420.0152



2.
10487
81.15501.5143



3.
10465
81.15501.5309



4.
10089
81.96210.0052



5.
10088
81.15901.0006
81.96601.0551



Horizontal
LHD
Standard

Series 16.280

Type

20/81 → 36/84



470
16.280 HOCL

D2866 TOH
12,0l tr.
6 cyl.
213 KW/290 HP

Front pipe

10653
81.15202.0070



10602
81.15202.5761



10603
81.15202.5762



Silencer

10566
81.15101.0153

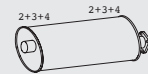

Tail pipe

10309
81.15202.5732



Mounting Parts

1.
10476
51.15901.0009
51.15901.0012



2.
10487
81.15501.5143



3.
10465
81.15501.5309



4.
10089
81.96210.0052



5.
10088
81.15901.0006
81.96601.0551



Horizontal
LHD
Standard

Series 16.280

Type

20/81 → 36/84



4X2

471
16.280 HOC

D2866 TOH
12,0l tr
6 cyl.
213 KW/290 HP

Front pipe

10653
81.15202.0070



10602
81.15202.5761



10603
81.15202.5762



Silencer

10571
81.15102.0068

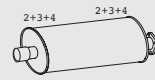

Tail pipe

N.A.
81.15202.5759

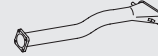

Mounting Parts

1.
10476
51.15901.0009
51.15901.0012



2.
10487
81.15501.5143



3.
10465
81.15501.5309



4.
10089
81.96210.0052



Horizontal
LHD
Standard

Series 16.280

Type

01/85 →



④X②

471
16.280 HOC

D2866 TOH
12,0l tr.
6 cyl.
213 KW/290 HP

Front pipe

10609
81.15202.5788



10604
81.15204.5507



10755
81.15210.0054



10600
81.15204.5508



Silencer

10557
81.15101.0189

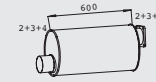

Tail pipe

10304
81.15204.5357



Mounting Parts

1.
00971
81.97420.0085
88.15640.2203
81.97420.0152



2.
10487
81.15501.5143



3.
10465
81.15501.5309



4.
10089
81.96210.0052



5.
10088
81.15901.0006
81.96601.0551



Horizontal
LHD
Standard

Series 16.290

Type

20/81 → 36/84



4X2

470

16.290 HOCL

D2866 TOH

12,0l tr.

6 cyl.

213 KW/290 HP

Front pipe

10653
81.15202.0070



10602
81.15202.5761



10603
81.15202.5762



Silencer

10566
81.15101.0153

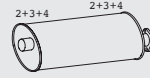

Tail pipe

10309
81.15202.5732



Mounting Parts

1.
10476
51.15901.0009
51.15901.0012



2.
10487
81.15501.5143



3.
10465
81.15501.5309



4.
10089
81.96210.0052



5.
10088
81.15901.0006
81.96601.0551



Horizontal
LHD
Standard

Series 16.290

Type

20/81 → 36/84



471
16.290 HOC

D2866 TOH
12,0l tr.
6 cyl.
213 KW/290 HP

Front pipe

10653
81.15202.0070



10602
81.15202.5761



10603
81.15202.5762



Silencer

10571
81.15102.0068

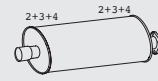

Tail pipe

N.A.
81.15202.5759



Mounting Parts

1.
10476
51.15901.0009
51.15901.0012



2.
10487
81.15501.5143



3.
10465
81.15501.5309



4.
10089
81.96210.0052



Horizontal
LHD
Standard

Series 16.360

Type

01/85 →



470
16.360 HOCL

D2866 LXOH
12,0l tr.
6 cyl.
265 KW/360 HP

Front pipe

10609
81.15202.5788



10604
81.15204.5507



10755
81.15210.0054



10600
81.15204.5508



Silencer

10557
81.15101.0189

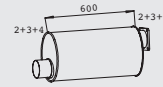

Tail pipe

10304
81.15204.5357

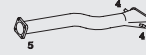

Mounting Parts

1.
00971
81.97420.0085
88.15640.2203
81.97420.0152



2.
10487
81.15501.5143



3.
10465
81.15501.5309



4.
10089
81.96210.0052



5.
10088
81.15901.0006
81.96601.0551



Horizontal
LHD
Standard

Series 16.360

Type

Euro I
25/90 → 18/93



470
16.360 HOCL

D2866 LXOH
12,0l tr.
6 cyl.
265 KW/360 HP

Front pipe

10612
81.15204.0041



10608
81.15204.6029



10607
81.15210.0064



10606
81.15204.5561



Silencer

10531
81.15101.0274
81.15101.0236



Tail pipe

10300
81.15204.5562



Mounting Parts

1.
10476
51.15901.0009
51.15901.0012



2.
00971
81.97420.0085
88.15640.2203
81.97420.0152



Horizontal
LHD
Standard

Series 16.360

Type

18/86 → 24/90



4X2

475

16.360 HOCL

18/86 → 24/90

D2866 LXOH

12,0l tr.

6 cyl.

265 KW/360 HP

Front pipe

10609
81.15202.5788



10604
81.15204.5507

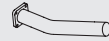

10755
81.15210.0054



10600
81.15204.5508



Silencer

10557
81.15101.0189

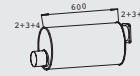

Tail pipe

10304
81.15204.5357

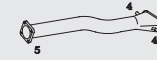

Mounting Parts

1.
00971
81.97420.0085
88.15640.2203
81.97420.0152



2.
10487
81.15501.5143



3.
10465
81.15501.5309



4.
10089
81.96210.0052



5.
10088
81.15901.0006
81.96601.0551



Horizontal
LHD
Standard

Series 16.360

Type

Euro I
25/90 →



475
16.360 HOCL

D2866 LXXH
12,0l tr.
6 cyl.
265 KW/360 HP

Front pipe

10612
81.15204.0041



10608
81.15204.6029



10607
81.15210.0064



10606
81.15204.5561



Silencer

10531
81.15101.0274
81.15101.0236



Tail pipe

10300
81.15204.5562

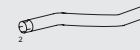

Mounting Parts

1.
10476
51.15901.0009
51.15901.0012



2.
00971
81.97420.0085
88.15640.2203
81.97420.0152



Horizontal
LHD
Standard

Series 16.372

Type

Euro I
25/90 →



470
16.372 HOCL
16/91 →

475
16.372 HOCL
25/90 →

D2866 LOHO7
12,0l tr.
6 cyl.
272 KW/372 HP

Front pipe

10612
81.15204.0041



10608
81.15204.6029



10607
81.15210.0064



10606
81.15204.5561



Silencer

10531
81.15101.0274
81.15101.0236



Tail pipe

10300
81.15204.5562



Mounting Parts

1.
10476
51.15901.0009
51.15901.0012



2.
00971
81.97420.0085
88.15640.2203
81.97420.0152



Horizontal
LHD
Standard

Series 16.372

Type

01/85 →



4X2

470
16.372 HOCL
01/85 →

475
16.372 HOCL
18/86 → 24/90

D2866 LOH07
12,0l tr.
6 cyl.
272 KW/372 HP

Front pipe

10609
81.15202.5788



10604
81.15204.5507

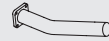

10755
81.15210.0054



10600
81.15204.5508



Silencer

10557
81.15101.0189

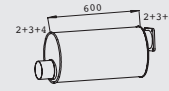

Tail pipe

10304
81.15204.5357



Mounting Parts

1.
00971
81.97420.0085
88.15640.2203
81.97420.0152



2.
10487
81.15501.5143



3.
10465
81.15501.5309



4.
10089
81.96210.0052



5.
10088
81.15901.0006
81.96601.0551



Horizontal
LHD
Standard

Series 18.220

Type

Euro II
10/98 →



A69
18.220 HOCL/R
NL

D0826 LOH
7,0l tr.
6 cyl.
162 KW/220 HP

Front pipe

<p>19676 88.15201.5125</p>	<p>19777 81.15210.0022</p>	<p>19680 83.94289.0529 83.15201.0502</p>
---------------------------------------	---------------------------------------	---

<p>10725 81.15202.0091 51.08103.0017</p>	<p>N A. 81.15901.0033 Only used if no exhaust brake fitted</p>	<p>19678 83.15201.5008</p> <p>→ 18/98</p>
---	---	--

19677
88.15201.5112

18/98 →

<p>10634 81.15210.0056</p>	<p>19680 83.94289.0529 83.15201.0502</p>
---------------------------------------	---

19777
81.15210.0022

18/98 →

Silencer

10559
81.15101.0250
81.15101.0238

19587
81.15101.0291
81.15101.0289

Tail pipe

19327
83.15201.0004

19325
88.15201.5111

→ 15/99

19321
81.15204.0469

15/99 →

Mounting Parts

1.
00942
06.67041.0121
81.97420.0023
06.67041.0133

2.
00940
06.67041.0123
06.67042.0122
88.15640.2205

3.
10061
81.96210.0100

4.
00988
06.67041.0124
06.67043.0124
88.15640.0005

5.
00981
81.97420.2017
83.97420.0500

Horizontal
LHD
Standard

Series 18.220

Type

Euro III
10/98 →



A69
18.220
HOCL/R NL

D0836 LOH
7,0l tr.
6 cyl.
162 KW/220 HP

Front pipe

19671
81.15205.5039



19777
81.15210.0022



19680
83.94289.0529
83.15201.0502



Silencer

19580
81.15101.0304

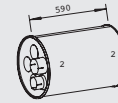

Tail pipe

19323
81.15204.0502

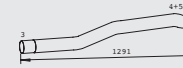

Mounting Parts

1.
00942
06.67041.0121
81.97420.0023
06.67041.0133



2.
10082
81.97460.5245



3.
00981
81.97420.2017
83.97420.0500



4.
00988
06.67041.0124
06.67043.0124
88.15640.0005



5.
10061
81.96210.0100



Horizontal
LHD
Standard

Series 18.220

Type

Euro III
10/98 →



A69
18.220
HOCL/R-NL

D2866 LUH
12,0l tr.
6 cyl.
177 KW/240 HP
191 KW/260 HP
228 KW/310 HP

Front pipeT

19675
83.15204.5532
83.15204.5525

Round Flange



Silencer

10594
81.15101.0303

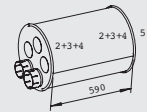

ail pipe

19322
83.15204.5531
83.15204.5526

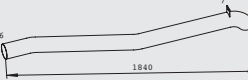

Mounting Parts

1.
00981
81.97420.2017
83.97420.0500



2.
10462
81.15501.5536



3.
10082
81.97460.5245



4.
10078
81.96210.0153
81.96210.0127
81.96210.0602



5.
10471
81.15110.0175



6.
00971
81.97420.0085
88.15640.2203
81.97420.0152



7.
10454
81.96210.0101



Horizontal
LHD
Standard

Series 18.220

Type

Euro IV
10/98 →



A69

D0836 LUH
7,0l tr.
6 cyl.
176 KW/240 HP
206 KW/280 HP

D2066 LUH
10,5l tr.
6 cyl.
228 KW/310 HP

Front pipe

Silencer

Tail pipe

14743
81.15205.5196

AEM Insulation

10743
81.15210.0071

14679
81.15205.5197

19568
81.15101.0382

CAT

19963
81.15205.5198

Mounting Parts

1.
00981
81.97420.2017
83.97420.0500

2.
10058
06.67410.3115

3.
00971
81.97420.0085
88.15640.2203
81.97420.0152

4.
10431
81.97488.0534
81.97487.0780

5.
10454
81.96210.0101

6.
10067
81.97460.5293
81.97460.5332

Horizontal
LHD/RHD
Standard

Series 18.220/230/250

Type

Euro III
36/93 → 25/01



A60
18.220/230/250
HOCL - SKD (SL)

D0826 LOH
7,0l tr.
6 cyl.
162 KW/220 HP
169 KW/230 HP
184 KW/250 HP

Auto

Front pipe

10725
81.15202.0091
51.08103.0017



N.A.

81.15901.0033
Only used if no
exhaust brake fitted

19678
83.15201.5008



10634
81.15210.0056



19680
83.94289.0529
83.15201.0502



Silencer

10559
81.15101.0250
81.15101.0238

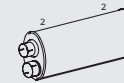

Tail pipe

19327
83.15201.0004

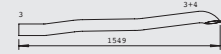

Mounting Parts

1.
00942
06.67041.0121
81.97420.0023
06.67041.0133



2.
28438
83.97460.5503



3.
00940
06.67041.0123
06.67042.0122
88.15640.2205



4.
10061
81.96210.0100



Horizontal
LHD
Standard

Series 18.220/230/250

Type

Euro III
36/93 → 25/01



A60
18.220/230/250
HOCL - SKD (SL)

D0826 LOH
7,0l tr.
6 cyl.
162 KW/220 HP
169 KW/230 HP
184 KW/250 HP

Auto

Front pipe

10725
81.15202.0091
51.08103.0017

N.A.
83.15901.0033
Only used if no
exhaust brake fitted

19684
83.15201.5506

19777
81.15210.0022

19680
83.94289.0529
83.15201.0502

Silencer

19587
81.15101.0291
81.15101.0289

Tail pipe

19326
83.15201.5505

Mounting Parts

1.
00942
06.67041.0121
81.97420.0023
06.67041.0133

2.
28438
83.97460.5503

3.
00981
81.97420.2017
83.97420.0500

4.
10061
81.96210.0100

Horizontal
LHD
Standard

Series 18.220/230/250

Type

Euro III
36/93 → 25/01



A60
18.220/230/250
HOCL - SKD (SL)

D0826 LOH
7,0l tr.
6 cyl.
162 KW/220 HP
169 KW/230 HP
184 KW/250 HP

Horizontal
LHD
Standard

Front pipe

10725
81.15202.0091
51.08103.0017



19684
83.15201.5506



19777
81.15210.0022



19680
83.94289.0529
83.15201.0502



Silencer

19587
81.15101.0291
81.15101.0289

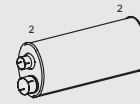

Tail pipe

19326
83.15201.5505

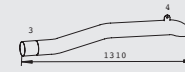

Mounting Parts

1.
00942
06.67041.0121
81.97420.0023
06.67041.0133



2.
28438
83.97460.5503



3.
00981
81.97420.2017
83.97420.0500



4.
10061
81.96210.0100



Series 18.220/280

Type

Euro III
25/02 →



A85
18.220
18.280
HOCL/R-CKD

D0836 LOH
7,0l tr.
6 cyl.
162 KW/220 HP
206 KW/280 HP

Horizontal
LHD
Standard

Front pipe

10725
81.15202.0091
51.08103.0017

19684
83.15201.5506

19777
81.15210.0022

19680
83.94289.0529
83.15201.0502

Silencer

19587
81.15101.0291
81.15101.0289

Tail pipe

19326
83.15201.5505

Mounting Parts

1.
00942
06.67041.0121
81.97420.0023
06.67041.0133

2.
28438
83.97460.5503

3.
00981
81.97420.2017
83.97420.0500

4.
10061
81.96210.0100

Series 18.260/410/460 HOCL/R

Type

Euro III
20/04 →



R33

D2866 LOH
12,0l tr.
6 cyl.
191 KW/260 HP
301 KW/410 HP

D2876LOH
13,0l tr.
6 cyl.
338 KW/460 HP

Front pipe

14760
81.15204.6057



19753
81.15210.0074



14761
81.15204.5812

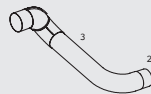

Silencer

10599
81.15101.0293
81.15101.0341

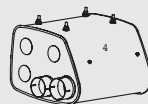

Tail pipe

19969
81.15204.0334

INOX

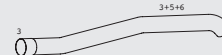

19953
81.15204.0536

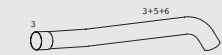

Mounting Parts

1.
00961
81.97420.0157
81.97420.0062



2.
19447
88.15640.0007
88.15640.2203



3.
10073
81.97420.5045
81.97420.0076



4.
10493
81.15110.0296



5.
10492
81.15501.0704



6.
10454
81.96210.0101



Horizontal
LHD/RHD
Standard

Series 18.310/350/370/400/420/460 HOCL/R

Type

Euro III
04/92 →



A51

D2866 LOH
12,0l tr.
6 cyl.
228 KW/310 HP
257 KW/350 HP
272 KW/370 HP
294 KW/400 HP
309 KW/420 HP

D2876LOH
13,0l tr.
6 cyl.
338 KW/460 HP

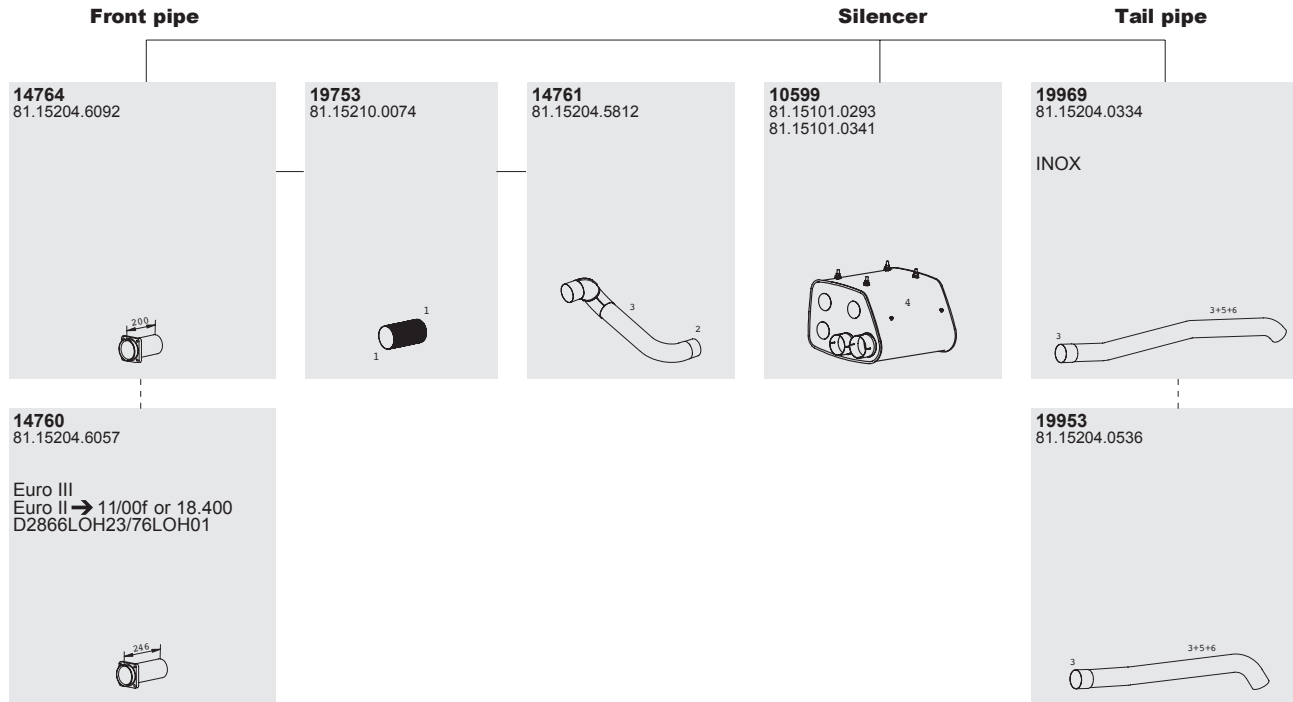

Mounting Parts

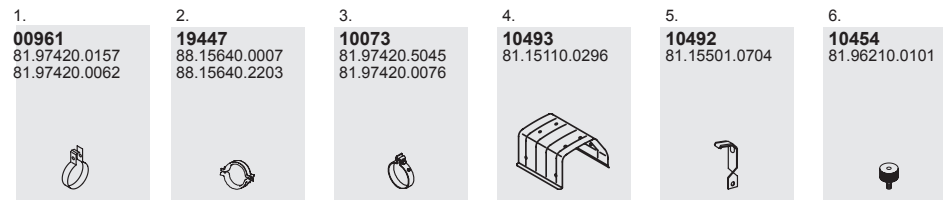

Horizontal
LHD/RHD
Standard

Series 18.310/350/370/400/410 HOCL/R LBC

Type

Euro III
26/02 →



A82

D2866 LOH
12,0l tr.
6 cyl.
228 KW/310 HP
257 KW/350 HP
272 KW/370 HP
294 KW/400 HP
301 KW/410 HP

Front pipe

14760
81.15204.6057

14764
81.15204.6092

19753
81.15210.0074

14761
81.15204.5812

Silencer

10599
81.15101.0293
81.15101.0341

Tail pipe

19969
81.15204.0334

INOX

19953
81.15204.0536

Mounting Parts

1.
00961
81.97420.0157
81.97420.0062

2.
19447
88.15640.0007
88.15640.2203

3.
10073
81.97420.5045
81.97420.0076

4.
10493
81.15110.0296

5.
10492
81.15501.0704

6.
10454
81.96210.0101

Horizontal
LHD/RHD
Standard

Series 18.310/350/370/400/420 HOCL/R-SDK

Type

Euro III
03/95 →



A55

D2866 LOH
12,0l tr.
6 cyl.
228KW/310 HP
257 KW/350 HP
272 KW/370 HP
294 KW/400 HP
309 KW/420 HP

Front pipe

14760
81.15204.6057

Euro II → 11/00f or
18.400

19753
81.15210.0074

14761
81.15204.5812

Silencer

10599
81.15101.0293
81.15101.0341

Tail pipe

19969
81.15204.0334

INOX

Mounting Parts

1.
00961
81.97420.0157
81.97420.0062

2.
19447
88.15640.0007
88.15640.2203

3.
10073
81.97420.5045
81.97420.0076

4.
10493
81.15110.0296

5.
10492
81.15501.0704

6.
10454
81.96210.0101

Horizontal
LHD/RHD
Standard

Series 18.310/370/470

Type

Euro II
04/92 → 11/00



A51
18.310 HOCL/R

D2866 LOH
12,0l tr.
6 cyl.
228 KW/310 HP
272 KW/372 HP
345 KW/470 HP

Front pipe

19753
81.15210.0074



19779
81.15204.5637



Silencer

10531
81.15101.0274
81.15101.0236



Tail pipe

10985
81.15204.0195



19380
81.15204.0267

►CHno 206-740



Mounting Parts

1.
00961
81.97420.0157
81.97420.0062



2.
00961
81.97420.0157
81.97420.0062



3.
10455
81.97460.5210



4.
00968
81.97420.0076



5.
10492
81.15501.0704



6.
10078
81.96210.0153
81.96210.0127
81.96210.0602



Horizontal
LHD
Standard

Series 19.290

Type

01/85 →



4X2

471
19.290 HOC

D2866 LXOH
12,0l tr.
6 cyl.
265 KW/360 HP

Front pipe

10609
81.15202.5788



10604
81.15204.5507



10755
81.15210.0054



10600
81.15204.5508



Silencer

10557
81.15101.0189

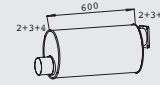

Tail pipe

10304
81.15204.5357



Mounting Parts

1.
00971
81.97420.0085
88.15640.2203
81.97420.0152



2.
10487
81.15501.5143



3.
10465
81.15501.5309



4.
10089
81.96210.0052



5.
10088
81.15901.0006
81.96601.0551



Horizontal
LHD
Standard

Series 22.330

Type

18/86 → 24/90



474
22.330 HOCLN

D2866 LOH
12,0l tr.
6 cyl.
242 KW/330 HP

Horizontal
LHD
Standard

Front pipe

10609
81.15202.5788



10604
81.15204.5507

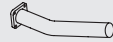

10755
81.15210.0054



10600
81.15204.5508



Silencer

10557
81.15101.0189

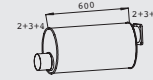

Tail pipe

10304
81.15204.5357

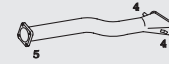

Mounting Parts

1.
00971
81.97420.0085
88.15640.2203
81.97420.0152



2.
10487
81.15501.5143



3.
10465
81.15501.5309



4.
10089
81.96210.0052



5.
10088
81.15901.0006
81.96601.0551



Series 22.360

Type

18/86 → 24/90



6XE

474
22.360 HOCLN

D2866 LXOH
12,0l tr.
6 cyl.
265 KW/360 HP

Front pipe

10609
81.15202.5788



10604
81.15204.5507

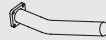

10755
81.15210.0054



10600
81.15204.5508



Silencer

10557
81.15101.0189

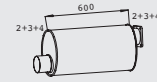

Tail pipe

10304
81.15204.5357

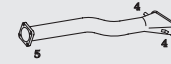

Mounting Parts

1.
00971
81.97420.0085
88.15640.2203
81.97420.0152



2.
10487
81.15501.5143



3.
10465
81.15501.5309



4.
10089
81.96210.0052



5.
10088
81.15901.0006
81.96601.0551



Horizontal
LHD
Standard

Series 22.360

Type

Euro I
25/90 →



474
22.360 HOCLN

25/90 →
D2866 LXOH
12,0l tr
6 cyl.
265 KW/360 HP

16/91 →
D2866 LOH
12,0l tr.
6 cyl.
272 KW/370 HP

Front pipe

10612
81.15204.0041



10608
81.15204.6029



10607
81.15210.0064



10606
81.15204.5561



Silencer

10531
81.15101.0274
81.15101.0236

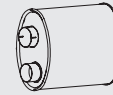

Tail pipe

10300
81.15204.5562



Mounting Parts

1.
10476
51.15901.0009
51.15901.0012



2.
00971
81.97420.0085
88.15640.2203
81.97420.0152



Horizontal
LHD
Standard

Series 24.350/400 HOCLN

Type

Euro III
03/97 →



A54

D2866 LOH
12,0l tr.
6 cyl.
257 KW/350 HP
294 KW/400 HP

Front pipe

14764
81.15204.6092



14760
81.15204.6057

Euro III
Euro II → 11/00f or 24.400
D2866LOH23/76LOH01



19753
81.15210.0074



14761
81.15204.5812

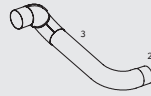

Silencer

10599
81.15101.0293
81.15101.0341

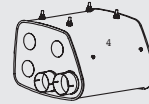

Tail pipe

19969
81.15204.0334

INOX

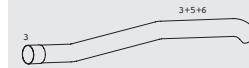

Mounting Parts

1.
00961
81.97420.0157
81.97420.0062



2.
19447
88.15640.0007
88.15640.2203



3.
10073
81.97420.5045
81.97420.0076



4.
10493
81.15110.0296

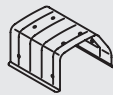

5.
10492
81.15501.0704



6.
10454
81.96210.0101



Horizontal
LHD/RHD
Standard

Series 24.400/460 HOCLN/R-CKD

Type

Euro III
36/01 →



A81

D2866 LOH23
12,0l tr.
6 cyl.
294 KW/400 HP

D2876LOH01
13,0l tr.
6 cyl.
338 KW/460 HP

Front pipe

14760
81.15204.6057



19753
81.15210.0074



14761
81.15204.5812

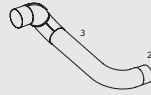

Silencer

10599
81.15101.0293
81.15101.0341

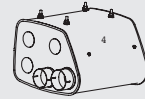

Tail pipe

19969
81.15204.0334

INOX

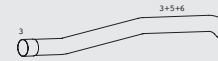

Mounting Parts

1.
00961
81.97420.0157
81.97420.0062



2.
19447
88.15640.0007
88.15640.2203



3.
10073
81.97420.5045
81.97420.0076



4.
10493
81.15110.0296



5.
10492
81.15501.0704



6.
10454
81.96210.0101



Horizontal
LHD/RHD
Standard

Series 290

Type

P599

Silencer

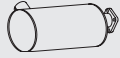
10535
81.15101.019910557
81.15101.0189

Horizontal
LHD
Standard

Series 292

Type

Euro I
01/86 → 28/93



880

D2866
TUH/TUH01/TUM
12,0l tr.
6 cyl.
222 KW/302 HP
224 KW/304 HP

Front pipe

Silencer

Tail pipe

10630
81.15204.5370



10697
81.15204.5384
81.15204.5474



10535
81.15101.0199

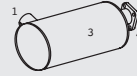

10306
81.15204.5359

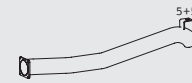

Mounting Parts

1.
00971
81.97420.0085
88.15640.2203
81.97420.0152



2.
10459
51.15901.0012
8.341.000.086



3.
10487
81.15501.5143



4.
10087
81.15901.0020
81.96601.0553



5.
10454
81.96210.0101



Horizontal
LHD
Standard

Series 292/332/362 H

Type

Euro I
01/86 → 28/93



882

D2866
TUH/TUH01/TUM
12,0l tr.
6 cyl.
222 KW/302 HP
224 KW/304 HP

Front pipe

Silencer

Tail pipe

10630
81.15204.5370



10697
81.15204.5384
81.15204.5474



10535
81.15101.0199

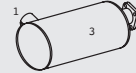

10306
81.15204.5359

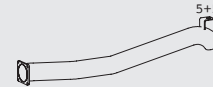

Mounting Parts

1.
00971
81.97420.0085
88.15640.2203
81.97420.0152



2.
10459
51.15901.0012
8.341.000.086



3.
10487
81.15501.5143



4.
10087
81.15901.0020
81.96601.0553



5.
10454
81.96210.0101



Horizontal
LHD
Standard

Series 292/332/362 H

Type

Euro I
16/90 → 29/93



882

D2866
LUH/LUH05/LXUH
12,0l tr.
6 cyl.
213 KW/290 HP
243 KW/330 HP
265 KW/360 HP

Front pipeT

Silencer

ail pipe

10696
81.15204.5516



10531
81.15101.0274
81.15101.0236



10305
81.15204.6030



Mounting Parts

1.
00961
81.97420.0157
81.97420.0062



2.
10450
81.15501.5590



3.
10418
81.15501.5589



4.
10454
81.96210.0101



5.
00968
81.97420.0076



Horizontal
LHD
Standard

Series 322/352/402/422/462 FRH

Type

Euro II
19/91 → 24/96



A03

D2865
LOH01/02/
05/07/09/10
10,0l tr.
5 cyl.
235 KW/320 HP

D2866
LOH/LXOH
LOH02/03/06/07/
09/20-26/30/31
12,0l tr.
6 cyl.
243 KW/330 HP
257 KW/350 HP
265 KW/360 HP
294 KW/400 HP
309 KW/420 HP

D2876 LOH01
13,0l tr.
6 cyl.
338 KW/460 HP

Front pipe

19760
81.15204.5628

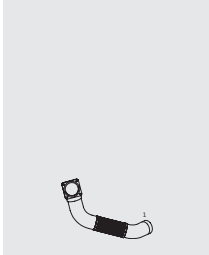

Silencer

10531
81.15101.0274
81.15101.0236

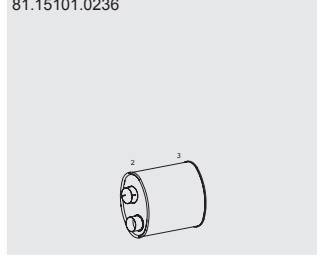

Tail pipe

19375
81.15204.5684

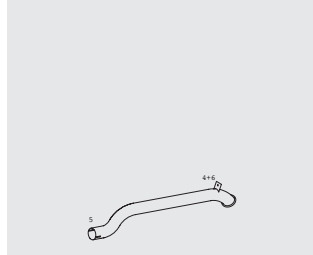

19372
81.15204.6042

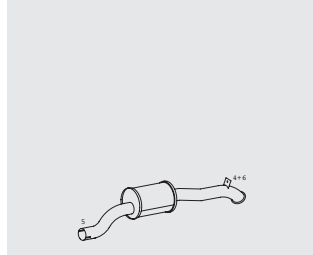

Mounting Parts

1.
00961
81.97420.0157
81.97420.0062



2.
10437
81.15502.5051



3.
10436
81.15502.5052



4.
10078
81.96210.0153
81.96210.0127
81.96210.0602

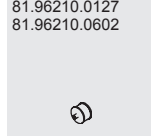

5.
00968
81.97420.0076

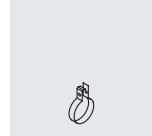

6.
10431
81.97488.0534
81.97487.0780



Horizontal
LHD
Standard

Series 322/352/402/422/462 FRH

Type

Euro III
28/94 → 36/02



A03
020-308 ▶CHno

D2865
LOH01/02/
05/07/08/09/10
10,0l tr.
5 cyl.
235 KW/320 HP

D2866
LOH/LXOH
LOH02/03/06/07/
09/20-26/30/31
12,0l tr.
6 cyl.
243 KW/330 HP
257 KW/350 HP
265 KW/360 HP
294 KW/400 HP
309 KW/420 HP

D2876 LOH01
13,0l tr.
6 cyl.
338 KW/460 HP

Front pipe

19751
81.15204.5720

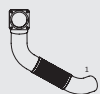

Silencer

19582
81.15101.0295
81.15101.0281



Tail pipe

19371
81.15204.5719



Mounting Parts

1.
00961
81.97420.0157
81.97420.0062



2.
00968
81.97420.0076



3.
10078
81.96210.0153
81.96210.0127
81.96210.0602



4.
10431
81.97488.0534
81.97487.0780



Horizontal
LHD
Standard

Series EL 202

Type

Euro II
10/93 →



A10
A11
A12

D0826
LUH/LUH213
7,0l tr.
6 cyl.
157 KW/213 HP

D0826
LUH01-06/
08/10/12/13
7,0l tr.
6 cyl.
162 KW/220 HP
169 KW/230 HP
191 KW/260 HP
198 KW/270 HP

DAB S15
Mark II

Front pipe

10691
81.15204.0411
81.15204.5525



10717
81.15204.5617

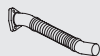

Silencer

10559
81.15101.0250
81.15101.0238

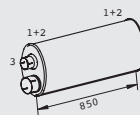

Tail pipe

10301
88.15204.5525
81.15204.5525

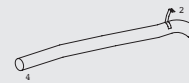

Mounting Parts

1.
10417
81.15502.5079
81.15501.6023
81.15502.5120



2.
10089
81.96210.0052



3.
00942
06.67041.0121
81.97420.0023
06.67041.0133



4.
00901
81.97420.0140
06.67041.0125
85.15640.0001



Horizontal
LHD
Standard

Series LION'S CITY

Type

Euro III
22/96 →



A21
NL 223
NL 263
NL 313

D0826
LUH/LUH213
7,0l tr.
6 cyl.
157 KW/213 HP

D0826
LUH01-06/
08/10/12/13
7,0l tr.
6 cyl.
162 KW/220 HP
169 KW/230 HP
191 KW/260 HP
198 KW/270 HP

Horizontal
LHD
Standard

Front pipeT

19674
81.15204.5853

→ 14/97
X

19666
81.15204.5883

X

Silencer

19580
81.15101.0304

X

ail pipe

19398
88.15201.5113

Tail pipe left rear
below rear corner

19329
88.15201.5095

Tail pipe left rear
below rear corner

19320
81.15204.5884

Tail pipe left rear
below rear corner

19397
88.15201.5117

Tail pipe left rear
by rear deflector

Mounting Parts

1.
00942
06.67041.0121
81.97420.0023
06.67041.0133

2.
10454
81.96210.0101

3.
10078
81.96210.0153
81.96210.0127
81.96210.0602

4.
10462
81.15501.5536

5.
10082
81.97460.5245

6.
10057
81.15110.0344
81.15110.0429

7.
00981
81.97420.2017
83.97420.0500

8.
10431
81.97488.0534
81.97487.0780

Series LION'S CITY

Type

Euro III
22/96 →



A21
NL 223
NL 263
NL 313

D0826/36 LUH
7,0l tr.
6 cyl.
162 KW/220 HP
191 KW/260 HP

D2866 LUH
12,0l tr.
6 cyl.
191 KW/260 HP
228 KW/310 HP

Page 1/3
Next page:
(syst. 247100118)
(syst. 247100119)

Horizontal
LHD
Standard

Front pipe

Silencer

19668
81.15204.5880

D2866 LUH

10594
81.15101.0303

19664
81.15205.5092
81.15204.5984

D2866 LUH

19665
81.15204.5948

D2866 LUH

10505
81.15101.0326

19669
81.15204.5980

D0826/36 LUH

Mounting Parts

1.
00981
81.97420.2017
83.97420.0500

2.
10462
81.15501.5536

3.
10078
81.96210.0153
81.96210.0127
81.96210.0602

4.
10082
81.97460.5245

5.
10057
81.15110.0344
81.15110.0429

6.
10476
51.15901.0009
51.15901.0012

7.
10058
06.67410.3115

8.
10067
81.97460.5293
81.97460.5332

Series LION'S CITY

Type

Euro III
22/96 →



A21
NL 223
NL 263
NL 313

D0826/36 LUH
7,0l tr.
6 cyl.
162 KW/220 HP
191 KW/260 HP

D2866 LUH
12,0l tr.
6 cyl.
191 KW/260 HP
228 KW/310 HP

Page 2/3
Previous page:
(syst. 247100107)

Horizontal
LHD
Standard

Silencer

Tail pipe

10594
81.15101.0303

19391
88.15201.5122

Tail pipe left rear
below rear corner

19392
88.15201.5127

Tail pipe left rear
below rear corner

19330
88.15201.5098

D2866 LUH
Tail pipe left rear below rear corner

19336
81.15204.5956

D2866 LUH
Tail pipe left rear
below rear corner

10505
81.15101.0326

19396
88.15201.5120

Tail pipe left rear
by rear deflector

19324
81.15204.5881

D2866 LUH
Tail pipe left rear below rear corner

19333
81.15205.5019

Euro III
 D2866 LUH
Tail pipe left rear
below rear corner

Mounting Parts

1.
10462
81.15501.5536

2.
10078
81.96210.0153
81.96210.0127
81.96210.0602

3.
10082
81.97460.5245

4.
10057
81.15110.0344
81.15110.0429

5.
10067
81.97460.5293
81.97460.5332

6.
00971
81.97420.0085
88.15640.2203
81.97420.0152

7.
10431
81.97488.0534
81.97487.0780

8.
10454
81.96210.0101

9.
10089
81.96210.0052

Series LION'S CITY

Type

Euro III
22/96 →



A21
NL 223
NL 263
NL 313

D0826/36 LUH
7,0l tr.
6 cyl.
162 KW/220 HP
191 KW/260 HP

D2866 LUH
12,0l tr.
6 cyl.
191 KW/260 HP
228 KW/310 HP

Page 3/3
Previous page:
(syst. 247100107)

Horizontal
LHD
Standard

Silencer

Tail pipe

10594
81.15101.0303

19332
81.15205.5006

Euro III
D2866 LUH
Tail pipe left rear below rear corner

19399
88.15201.5148
88.15201.5137

Euro III
D2866 LUH
Tail pipe left rear below rear corner

19393
88.15201.5145
88.15201.5135

Euro III
D2866 LUH
Tail pipe left rear below rear corner

19337
81.15204.5949

Tail pipe left rear below rear corner

10505
81.15101.0326

19335
81.15204.5974
81.15204.5986

D2866 LUH
Tail pipe left rear below rear corner

19331
81.15204.5991

Tail pipe left rear below rear corner

19395
88.15201.5121

D2866 LUH
Tail pipe left rear below rear corner

Mounting Parts

1.
10462
81.15501.5536

2.
10078
81.96210.0153
81.96210.0127
81.96210.0602

3.
10082
81.97460.5245

4.
10057
81.15110.0344
81.15110.0429

5.
10067
81.97460.5293
81.97460.5332

6.
00971
81.97420.0085
88.15640.2203
81.97420.0152

7.
10431
81.97488.0534
81.97487.0780

8.
10454
81.96210.0101

Series LION'S CITY

Type

Euro II
22/96 → 02/00



A21

D0826 LUH

01-06/08/10/12/13

7,0l tr.
6 cyl.
157 KW/213 HP
162 KW/220 HP
168 KW/230 HP
198 KW/270 HP

CRT

Front pipe

10691
81.15204.0411
81.15204.5552

CRT



19667
81.15204.5882

CRT

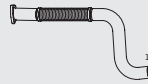

19666
81.15204.5883

CRT

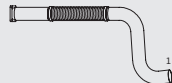

Silencer

19567
81.15101.0314

CRT
→ 02/00

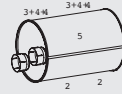

Tail pipe

19398
88.15201.5113

Tail pipe left rear below rear corner,
30 grad

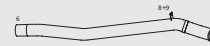

19396
88.15201.5120

Tail pipe left by rear deflector



19329
88.15201.5095

Tail pipe left rear below rear corner

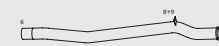

19397
88.15201.5117

Tail pipe left by rear deflector



19391
88.15201.5122

Tail pipe left rear below rear corner

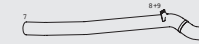

19320
81.15204.5884

Tail pipe left rear below rear corner



19395
88.15201.5121

Tail pipe rear below rear corner

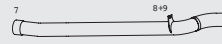

19337
81.15204.5949

Tail pipe left rear below rear corner
→ 08/00

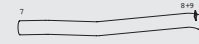

Mounting Parts

1.
00942
06.67041.0121
81.97420.0023
06.67041.0133



2.
10067
81.97460.5293
81.97460.5332



3.
10462
81.15501.5536



4.
10078
81.96210.0153
81.96210.0127
81.96210.0602



5.
10057
81.15110.0344
81.15110.0429



6.
00981
81.97420.2017
83.97420.0500



7.
00971
81.97420.0085
88.15640.2203
81.97420.0152



8.
10431
81.97488.0534
81.97487.0780



9.
10454
81.96210.0101



Horizontal
LHD/RHD
Standard

Series LION'S CITY

Type

Euro III
22/96 → 12/03



A21

D0836
LUH01/02/40/41
7,0l tr.
6 cyl.
162 KW/220 HP
177 KW/240 HP
206 KW/280 HP

Front pipe

14752
81.15205.5068

D0836 LUH01/02

14753
81.15205.5066

D0836 LUH40/41

Silencer

19569
81.15103.6001

DPF
Complete unit
Replaced to parts:6,7,8,9,10,11

Tail pipe

19959
81.15205.5098

Tail pipe left by rear deflector

19958
81.15205.5107

Tail pipe rear shortl left, lower

Mounting Parts

1.
10058
06.67410.3115

2.
10078
81.96210.0153
81.96210.0127
81.96210.0602

3.
00971
81.97420.0085
88.15640.2203
81.97420.0152

4.
10454
81.96210.0101

5.
10431
81.97488.0534
81.97487.0780

6. Inlet
19469
81.15103.0000

7. CAT
19881
81.15103.0001

8. DPF
19882
81.15103.0002

9. Outlet
19460
81.15103.0003

10. Gasket for Pos.
6+7, 7+8, 8+9
19457
81.15103.0005

11.V-clamp for
Pos. 6+7, 7+8, 8+9
94462
81.15103.0004

Horizontal
LHD/RHD
Standard

Series LION'S CITY

Type

Euro III
03/02 →



A37
NL 243/283

D0836
LOH40/41/50
7,0l tr.
6 cyl.
177 KW/240 HP
206 KW/280 HP

Front pipe

10691
81.15204.0411
81.15204.5552

14750
81.15205.5122

Silencer

19561
81.15103.6003

DPF
Complete unit
Replaced to parts:6,7,8,9,10,11

Tail pipe

19950
81.15205.5125

Mounting Parts

1.
10056
51.09901.0036
51.09901.0036
51.09901.0036

2.
10058
06.67410.3115

3.
10078
81.96210.0153
81.96210.0127
81.96210.0602

4.
00971
81.97420.0085
88.15640.2203
81.97420.0152

5.
10454
81.96210.0101

6. Inlet
10028
81.15103.0019

7. CAT
19887
81.15103.0020

8. DPF
19886
81.15230.0024

9. Outlet
10027
81.15103.0021

10. Gasket for Pos.
6+7, 7+8, 8+9
10018
81.15103.0022

11.V -clamp for
Pos. 6+7, 7+8, 8+9
94462
81.15103.0004

Horizontal
LHD/RHD
Standard

Series LION'S CITY

Type

Euro III
13/03 →



A21

D0836
LUH01/02/40/41
7,0l tr.
6 cyl.
162 KW/220 HP
177 KW/240 HP
206 KW/280 HP

Front pipe

14754
81.15205.5105

Silencer

19561
81.15103.6003

DPF
Complete unit
Replaced to parts:6,7,8,9,10,11

Tail pipe

19960
81.15205.5109

Tail pipe left by rear deflector
26/03 →

19959
81.15205.5098

Tail pipe left by rear deflector
→ 25/03

19958
81.15205.5107

Tail pipe rear shortl left, lower

Mounting Parts

1.
10058
06.67410.3115

2.
10078
81.96210.0153
81.96210.0127
81.96210.0602

3.
00971
81.97420.0085
88.15640.2203
81.97420.0152

4.
10454
81.96210.0101

5.
10431
81.97488.0534
81.97487.0780

6. Inlet
10028
81.15103.0019

7. CAT
19887
81.15103.0020

8. DPF
19886
81.15230.0024

9. Outlet
10027
81.15103.0021

10. Gasket for Pos.
6+7, 7+8, 8+9
10018
81.15103.0022

11.V -clamp for
Pos. 6+7, 7+8, 8+9
94462
81.15103.0004

Horizontal
LHD/RHD
Standard

Series LION'S CITY

Type

Euro IV
11/05 →



A37
NL 243/283

D0836
LOH40/41/50
7,0l tr.
6 cyl.
177 KW/240 HP
206 KW/280 HP

Front pipe

14717
81.15205.5166

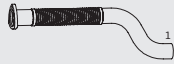

Silencer

19570
81.15101.0394

CAT

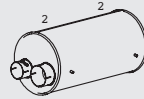

Tail pipe

19955
81.15205.5172

Tail pipe left rear below rear corner

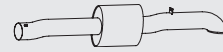

Mounting Parts

1.
00942
06.67041.0121
81.97420.0023
06.67041.0133



2.
10089
81.96210.0052



Horizontal
LHD/RHD
Standard

Series LION'S CITY DD

Type

Euro III
34/03 →



A39
(ND313)

D2866 LUH23/
24/25/27-30,
34-37,50-52
12,0l tr.
6 cyl.
191 KW/260 HP
228 KW/310 HP
265 KW/360 HP
301 KW/410 HP

Front pipeT

14758
81.15205.5129

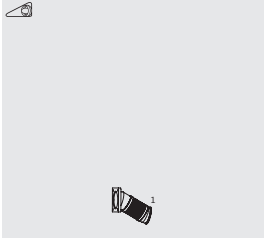

Silencer

19561
81.15103.6003

DPF
Complete unit
Replaced to parts:6,7,8,9,10,11

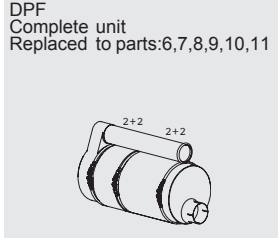

ail pipe

19917
81.15205.5189

Tail pipe left rear below rear corner

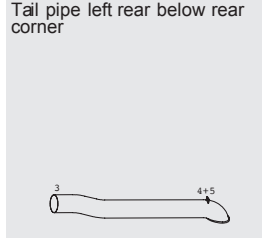

Mounting Parts

1.
10058
06.67410.3115



2.
10078
81.96210.0153
81.96210.0127
81.96210.0602

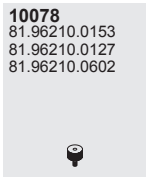

3.
00971
81.97420.0085
88.15640.2203
81.97420.0152



4.
10454
81.96210.0101

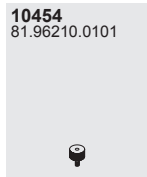

5.
10431
81.97488.0534
81.97487.0780

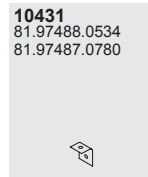

6. Inlet
10028
81.15103.0019



7. CAT
19887
81.15103.0020

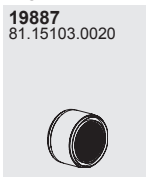

8. DPF
19886
81.15230.0024



9. Outlet
10027
81.15103.0021

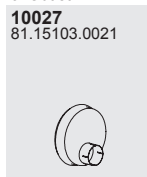

10. Gasket for Pos.
6+7, 7+8, 8+9
10018
81.15103.0022

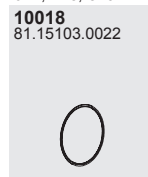

11.V -clamp for
Pos. 6+7, 7+8, 8+9
94462
81.15103.0004



Horizontal
LHD/RHD
Standard

Series LION'S CITY DD

Type

Euro III
34/03 →



A39
ND313

D2866 LUH23/
24/25/27-30,
34-37,50-52
12,0l tr.
6 cyl.
191 KW/260 HP
228 KW/310 HP
265 KW/360 HP
301 KW/410 HP

Front pipe

14715
81.15205.5103



14627
81.15210.0094



Silencer

19565
81.15103.6002
81.15103.6004

DPF
Complete unit
Replaced to parts:5,6,7,8,9,10

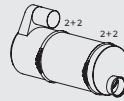

Tail pipe

19912
81.15204.5975

Tail pipe left rear below rear corner

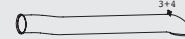

Mounting Parts

1.
00577
81.15103.0010



2.
10078
81.96210.0153
81.96210.0127
81.96210.0602



3.
10454
81.96210.0101



4.
10431
81.97488.0534
81.97487.0780



5. Inlet with CAT
19479
81.15103.0006



6. DPF
19885
81.15103.0016
81.15103.6016



7. Outlet
19462
81.15103.0007



8. Ring
19474
81.15103.0014



9. Gasket for Pos.
5+6, 6+7
19470
81.15103.0008



10. V-clamp for
Pos. 5+6, 6+7
94483



Horizontal
LHD/RHD
Standard

Series LION'S CITY G

Type

Euro III
34/96 →



A23
NG 263
NG 313

D2866 LUH
12,0l tr.
6 cyl.
191 KW/260 HP
228 KW/310 HP

Front pipe

Silencer

Tail pipe

19668
81.15204.5880

→ 02/00

10594
81.15101.0303

→ 02/00

19324
81.15204.5881

09/97 → 02/00
Tail pipe left rear
below rear corner

19335
81.15204.5974
81.15204.5986

09/00 →
Tail pipe left rear
below rear corner

19330
88.15201.5098

34/97 → 02/00
Tail pipe left rear
below rear corner

19665
81.15204.5948

24/99 →

10505
81.15101.0326

24/99 →

19337
81.15204.5949

36/98 →
D2866 LUH
Tail pipe left rear
below rear corner

19331
81.15204.5991

36/98 →
Tail pipe left rear
below rear corner

19391
88.15201.5122

Tail pipe left rear
below rear corner

Mounting Parts

1.
10476
51.15901.0009
51.15901.0012

2.
10058
06.67410.3115

3.
10067
81.97460.5293
81.97460.5332

4.
10462
81.15501.5536

5.
10078
81.96210.0153
81.96210.0127
81.96210.0602

6.
10082
81.97460.5245

7.
10057
81.15110.0344
81.15110.0429

8.
00981
81.97420.2017
83.97420.0500

9.
00971
81.97420.0085
88.15640.2203
81.97420.0152

10.
10431
81.97488.0534
81.97487.0780

11.
10454
81.96210.0101

Horizontal
LHD
Standard

Series LION'S CITY G

Type

Euro III
20/00 →



A23
NG 263
NG 313

D2866
LUH20-30/
34-37/50-52

12,0l tr.
6 cyl.
191 KW/260 HP
228 KW/310 HP
257 KW/350 HP
265 KW/360 HP
301 KW/410 HP

Front pipeT

19664
81.15205.5092
81.15204.5984

Silencer

10505
81.15101.0326

ail pipe

19332
81.15205.5006

Tail pipe left rear
below rear corner

19399
88.15201.5148
88.15201.5137

Tail pipe left rear
below rear corner

19393
88.15201.5145
88.15201.5135

Euro III
Tail pipe left rear
below rear corner

19390
88.15201.5153

Tail pipe by side panel

Mounting Parts

1.
10476
51.15901.0009
51.15901.0012

2.
10058
06.67410.3115

3.
10462
81.15501.5536

4.
10078
81.96210.0153
81.96210.0127
81.96210.0602

5.
10067
81.97460.5293
81.97460.5332

6.
10057
81.15110.0344
81.15110.0429

8.
00971
81.97420.0085
88.15640.2203
81.97420.0152

9.
10431
81.97488.0534
81.97487.0780

10.
10454
81.96210.0101

Horizontal
LHD
Standard

Series LION'S CITY M

Type

Euro III
11/05 →



A47
NL 243/283

D0836
LOH40/41/50
7,0l tr.
6 cyl.
177 KW/240 HP
206 KW/280 HP

Front pipe

10691
81.15204.0411
81.15204.5552



14750
81.15205.5122



Silencer

19561
81.15103.6003

DPF
Complete unit
Replaced to parts:6,7,8,9,10,11

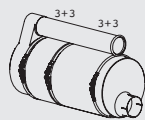

Tail pipe

19950
81.15205.5125

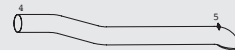

Mounting Parts

1.
10056
51.09901.0036
51.09901.0036
51.09901.0036



2.
10058
06.67410.3115



3.
10078
81.96210.0153
81.96210.0127
81.96210.0602



4.
00971
81.97420.0085
88.15640.2203
81.97420.0152



5.
10454
81.96210.0101



6. Inlet
10028
81.15103.0019



7. CAT
19887
81.15103.0020



8. DPF
19886
81.15230.0024



9. Outlet
10027
81.15103.0021



10. Gasket for Pos.
6+7, 7+8, 8+9

10018
81.15103.0022



11.V-clamp for
Pos. 6+7, 7+8, 8+9

94462
81.15103.0004



Horizontal
LHD/RHD
Standard

Series LION'S CITY M

Type

Euro IV
11/05 →



A47
NL 243/283

D0836
LOH40/41/50
7,0l tr.
6 cyl.
177 KW/240 HP
206 KW/280 HP

Horizontal
LHD/RHD
Standard

Front pipe

14717
81.15205.5166



Silencer

19570
81.15101.0394

CAT

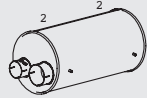

Tail pipe

19955
81.15205.5172

Tail pipe left rear below rear corner

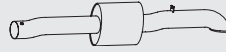

Mounting Parts

1.
00942
06.67041.0121
81.97420.0023
06.67041.0133



2.
10089
81.96210.0052



Series LION'S CITY T

Type

Euro III
33/02 →



A78

D0836
LOH01/02/03/04
7,0l tr.
6 cyl.
162 KW/220 HP
206 KW/280 HP

Front pipeT

14718
83..15201.5522

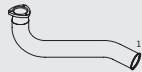

Silencer

19561
81.15103.6003

DPF
Complete unit
Replaced to parts:4,5,6,7,8,9

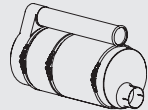

ail pipe

19916
83.15201.5515



Mounting Parts

1.
10058
06.67410.3115



2.
00971
81.97420.0085
88.15640.2203
81.97420.0152



3.
10454
81.96210.0101



4. Inlet
10028
81.15103.0019

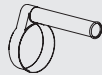

5. CAT
19887
81.15103.0020



6. DPF
19886
81.15230.0024



7. Outlet
10027
81.15103.0021



8. Gasket for Pos.
4+5, 5+6, 6+7
10018
81.15103.0022



9. V-clamp for Pos.
4+5, 5+6, 6+7
94462
81.15103.0004



Horizontal
LHD/RHD
Standard

Series LION'S CITY/LION'S CITY UE

Type

Euro II



A20

13/96 →

A21

22/96 →

D0826 LUH

01-06/08/10/12/13

7,0l tr.

6 cyl.

157 KW/213 HP

162 KW/220 HP

169 KW/230 HP

198 KW/270 HP

D0836 LUH

01/02/40/41/50

7,0l tr.

6 cyl.

162 KW/220 HP

177 KW/240 HP

206 KW/280 HP

Page 1/2

Next page:

(syst. 247000023)

Horizontal
LHD/RHD
Standard

Front pipe

10691
81.15204.0411
81.15204.5552

19663
81.15204.5958

14756
81.15205.5043

With OXI- CAT
A20/21 D0836 LUH41
 Auto D854.3
A21D 0836 LUH40
 Auto 5HP502
A21D 0836 LUH41
A21D 0836 LUH41,
prepared CRT

19669
81.15204.5980

With OXI- CAT

Silencer

10505
81.15101.0326

Without OXI- CAT

19566
81.15101.0338

CRT

Mounting Parts

1.
10056
51.09901.0036
51.09901.0036
51.09901.0036

2.
10058
06.67410.3115

3.
10067
81.97460.5293
81.97460.5332

4.
10462
81.15501.5536

5.
10057
81.15110.0344
81.15110.0429

6.
10078
81.96210.0153
81.96210.0127
81.96210.0602

7.
10082
81.97460.5245

Series LION'S CITY/LION'S CITY UE

Type

Euro II



A20
13/96 →

A21
22/96 →

D0826 LUH
01-06/08/10/12/13
7,0l tr.
6 cyl.
157 KW/213 HP
162 KW/220 HP
169 KW/230 HP
198 KW/270 HP

D0836 LUH
01/02/40/41/50
7,0l tr.
6 cyl.
162 KW/220 HP
177 KW/240 HP
206 KW/280 HP

Page 2/2
Previous page:
(syst. 247000022)

Horizontal
LHD/RHD
Standard

Silencer

Tail pipe

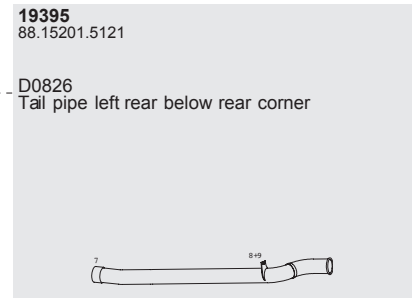
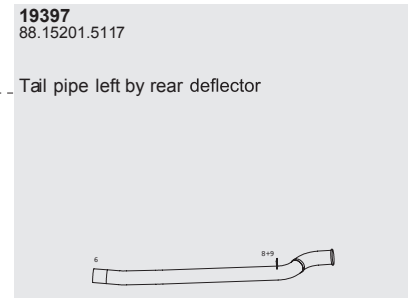
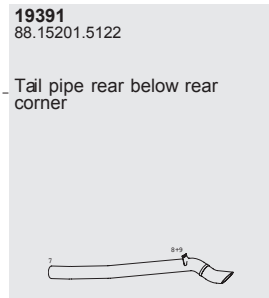
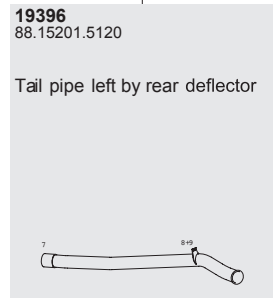
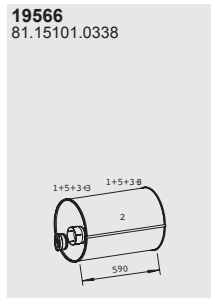
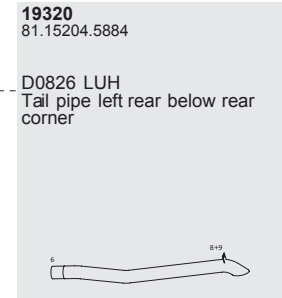
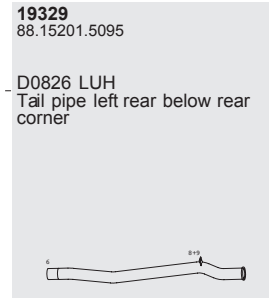
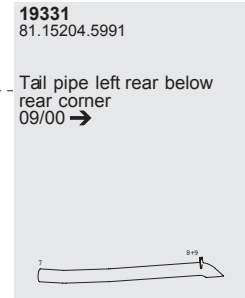
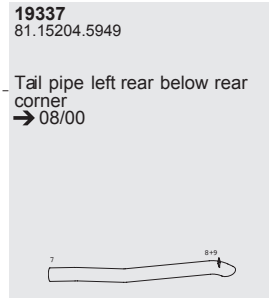
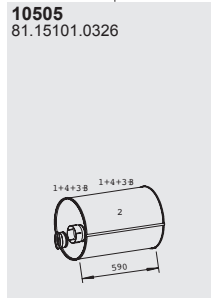

Mounting Parts

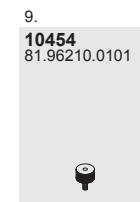
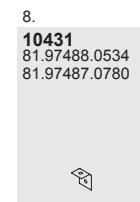
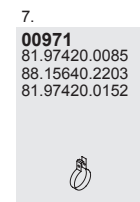
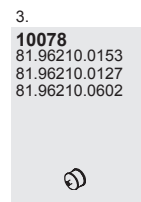
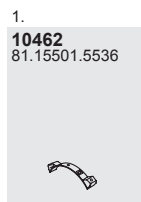

Series LION'S CITY/LION'S CITY UE

Type

Euro III
13/96 →



A20
A21

D0836
LUH01/02/40/41
7,0l tr.
6 cyl.
162 KW/220 HP
177 KW/240 HP
206 KW/280 HP

Front pipe

10691
81.15204.0411
81.15204.5552

14754
81.15205.5105

D0836 LUH01/02

14759
81.15205.5113

D0836 LUH40/41

Silencer

19561
81.15103.6003

DPF
Complete unit
Replaced to
parts:7,8,9,10,11,12

Tail pipe

19960
81.15205.5109

Tail pipe left by rear deflector
26/03 →

19959
81.15205.5098

Tail pipe left by rear deflector
→ 25/03

19958
81.15205.5107

Tail pipe rear short left, lower

Mounting Parts

1.
10056
51.09901.0036
51.09901.0036
51.09901.0036

2.
10058
06.67410.3115

3.
10078
81.96210.0153
81.96210.0127
81.96210.0602

4.
00971
81.97420.0085
88.15640.2203
81.97420.0152

5.
10454
81.96210.0101

6.
10431
81.97488.0534
81.97487.0780

10. Outlet
10027
81.15103.0021

11. Gasket for Pos.
7+8, 8+9, 9+10
10018
81.15103.0022

12. V-clamp for
Pos. 7+8, 8+9,
9+10
94462
81.15103.0004

7. Inlet
10028
81.15103.0019

8. CAT
19887
81.15103.0020

9. DPF
19886
81.15230.0024

Horizontal
LHD/RHD
Standard

Series LION'S CITY/LION'S CITY UE

Type

Euro III
13/96 →



4X2

A20
A21

D0836
LUH01/02/40/41
7,0l tr.
6 cyl.
162 KW/220 HP
177 KW/240 HP
206 KW/280 HP

Front pipe

14716
81.15205.5054



14627
81.15210.0094



Silencer

19565
81.15103.6002
81.15103.6004

DPF
Complete unit
Replaced to
parts:2,3,4,5,6,7

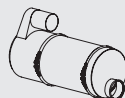

19287
81.15103.0017

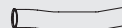

Tail pipe

19918
81.15205.5085



Mounting Parts

1.
00577
81.15103.0010



2. Inlet with CAT
19479
81.15103.0006



3. DPF
19885
81.15103.0016
81.15103.6016



4. Outlet
19462
81.15103.0007



5. Ring
19474
81.15103.0014



6. Gasket for Pos.
2+3, 3+4
19470
81.15103.0008



7. V-clamp for Pos.
2+3, 3+4
94483



Horizontal
LHD/RHD
Standard

Series LION'S CITY UE

Type

Euro III
13/96 →



A20
NUE 223
NUE 263
NUE 313

D0826/36 LUH
7,0l tr.
6 cyl.
162 KW/220 HP
191 KW/260 HP

D2866 LUH
12,0l tr.
6 cyl.
228 KW/310 HP

Page 1/2
Next page:
(syst. 247100120)

Horizontal
LHD
Standard

Front pipe

19662
81.15204.5954

D2866 LUH



19664
81.15205.5092
81.15204.5984

D2866 LUH



19665
81.15204.5948

D2866 LUH



19505
81.15101.0326

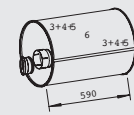

10691
81.15204.0411
81.15204.5552

D0826/36 LUH



19633
81.15204.5958

D0826/36 LUH



19669
81.15204.5980

D0826/36

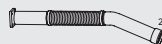

Silencer

Mounting Parts

1.

10476
51.15901.0009
51.15901.0012



2.

10058
06.67410.3115



3.

10462
81.15501.5536



4.

10078
81.96210.0153
81.96210.0127
81.96210.0602



5.

10067
81.97460.5293
81.97460.5332



6.

10057
81.15110.0344
81.15110.0429



7.

10056
51.09901.0036
51.09901.0036
51.09901.0036



Series LION'S CITY UE

Type

Euro III
13/96 →



A20
NUE 223
NUE 263
NUE 313

D0826/36 LUH
7,0l tr.
6 cyl.
162 KW/220 HP
191 KW/260 HP

D2866 LUH
12,0l tr.
6 cyl.
228 KW/310 HP

Silencer

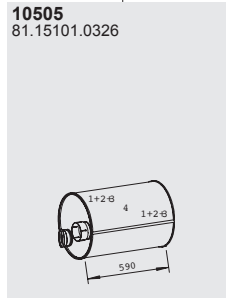

Tail pipe

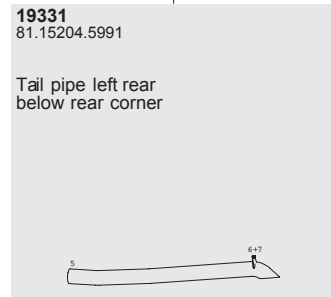

Mounting Parts

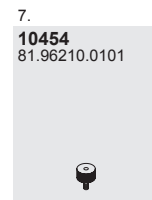
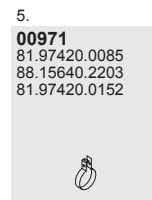
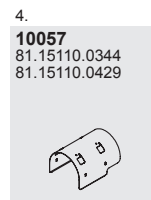
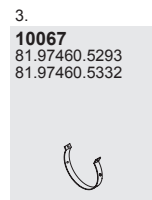
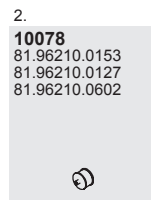

Page 2/2
Previous page:
(syst. 247100102)

Horizontal
LHD
Standard

Series LION'S CITY UE

Type

Euro II
→ 21/98



A20
NUE 223
NUE 263
NUE 313

D2866 LUH
12,0l tr.
6 cyl.
191 KW/260 HP
228 KW/310 HP

Front pipeT

Silencer

ail pipe

91668
81.15204.5880

10594
81.15101.0303

19324
81.15204.5881

Tail pipe left rear
below rear corner

19334
88.15201.5092

Tail pipe left rear
below rear corner

19670
81.15204.5879

19338
81.15204.5932

D2866 LUH22
Tail pipe left rear
below rear corner

Mounting Parts

1.
00981
81.97420.2017
83.97420.0500

2.
10462
81.15501.5536

3.
10078
81.96210.0153
81.96210.0127
81.96210.0602

4.
10082
81.97460.5245

5.
10057
81.15110.0344
81.15110.0429

6.
00971
81.97420.0085
88.15640.2203
81.97420.0152

7.
10431
81.97488.0534
81.97487.0780

8.
10454
81.96210.0101

Horizontal
LHD
Standard

Series LION'S CITY UE

Type

Euro II
→ 21/98



A20
NUE 223
NUE 263
NUE 313

D2866 LUH
12,0l tr.
6 cyl.
191 KW/260 HP
228 KW/310 HP

Front pipeT

Silencer

ail pipe

91668
81.15204.5880

10594
81.15101.0303

19324
81.15204.5881

Tail pipe left rear
below rear corner

19334
88.15201.5092

Tail pipe left rear
below rear corner

19670
81.15204.5879

19338
81.15204.5932

D2866 LUH22
Tail pipe left rear
below rear corner

Mounting Parts

1.
00981
81.97420.2017
83.97420.0500

2.
10462
81.15501.5536

3.
10078
81.96210.0153
81.96210.0127
81.96210.0602

4.
10082
81.97460.5245

5.
10057
81.15110.0344
81.15110.0429

6.
00971
81.97420.0085
88.15640.2203
81.97420.0152

7.
10431
81.97488.0534
81.97487.0780

8.
10454
81.96210.0101

Horizontal
LHD
Standard

Series LION'S CITY UE

Type

Euro III
13/96 →



A20
NUE 223
NUE 263
NUE 313

D0826 LUH
7,0l tr.
6 cyl.
157 KW/213 HP
162 KW/220 HP
191 KW/260 HP

Front pipeT

Silencer

ail pipe

19674
81.15204.5853

19580
81.15101.0304

19320
81.15204.5884

Tail pipe left rear
below rear corner

19666
81.15204.5883

10329
88.15201.5095

Tail pipe left rear
below rear corner

Mounting Parts

1.
00942
06.67041.0121
81.97420.0023
06.67041.0133

2.
10454
81.96210.0101

3.
10078
81.96210.0153
81.96210.0127
81.96210.0602

4.
10462
81.15501.5536

5.
10082
81.97460.5245

6.
10057
81.15110.0344
81.15110.0429

7.
00981
81.97420.2017
83.97420.0500

8.
10431
81.97488.0534
81.97487.0780

Horizontal
LHD
Standard

Series LION'S CITY/LION'S CITY UE/G/UELL/LL

Type

Euro III



A20
Lion's City UE
13/96 →
A21
Lion's City
22/96 →



A23
Lion's City G
34/96 →
A25
Lion's City UELL
08/98 →
A26
Lion's City LL
34/98 →

D2865 LUH
02/03/05-09
10,0l tr.
5 cyl.
191 KW/260 HP
198 KW/270 HP
228 KW/310 HP
235 KW/320 HP

D2866 LUH
01/02/20-30,
34-37,50-82
12,0l tr.
6 cyl.
191 KW/260 HP
228 KW/310 HP
257 KW/350 HP
265 KW/360 HP

Page 1/3
Next page:
(syst. 247000026)
(syst. 247000027)

Horizontal
LHD/RHD
Standard

Front pipeS

ilencer

19670
81.15204.5879

14711
81.15204.5846

10594
81.15101.0303

19562
81.15101.0315

A20/A21/A23
D2866 LUH22
CRT

19668
81.15204.5880

14713
81.15204.5855

D2865 LUH

19563
81.15101.0313

A20/A21/A23
D2866 LUH22
CRT

Mounting Parts

1. **00981**
81.97420.2017
83.97420.0500

2. **10082**
81.97460.5245

3. **10462**
81.15501.5536

4. **10064**
81.15240.5008

5. **10060**
81.15240.5009

6. **10078**
81.96210.0153
81.96210.0127
81.96210.0602

7. **10067**
81.97460.5293
81.97460.5332

8. **10057**
81.15110.0344
81.15110.0429

9. **10454**
81.96210.0101

Series LION'S CITY/LION'S CITY UE/G/UELL/LL

Type

Euro III



A20
Lion's City UE
13/96 →

A21
Lion's City
22/96 →



A23
Lion's City G
34/96 →

A25
Lion's City UELL
08/98 →

A26
Lion's City LL
34/98 →

D2865 LUH
02/03/05-09
10,0l tr.
5 cyl.
191 KW/260 HP
198 KW/270 HP
228 KW/310 HP
235 KW/320 HP

D2866 LUH
01/02/20-30,
34-37,50-82
12,0l tr.
6 cyl.
191 KW/260 HP
228 KW/310 HP
257 KW/350 HP
265 KW/360 HP

Page 2/3
Previous page:
(syst.247000025)

Horizontal
LHD/RHD
Standard

Silencer

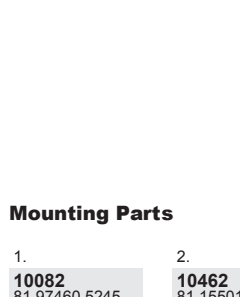
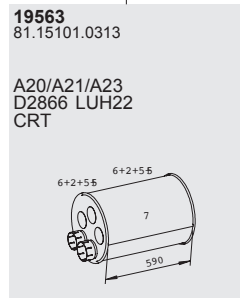
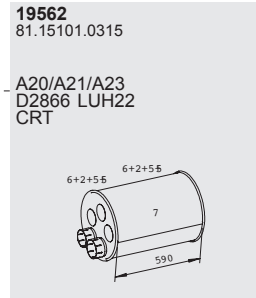
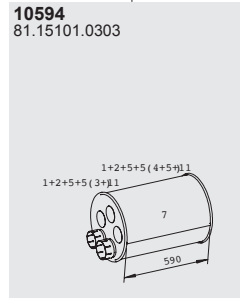

Tail pipe

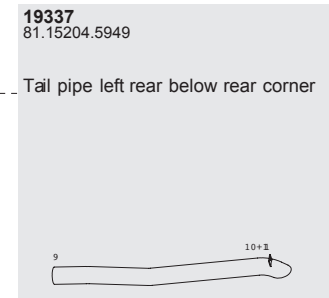
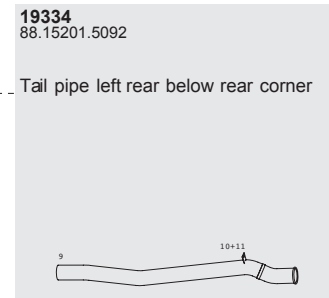
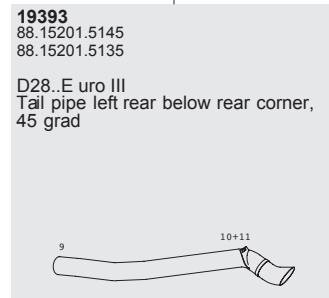
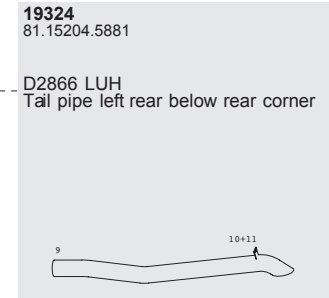
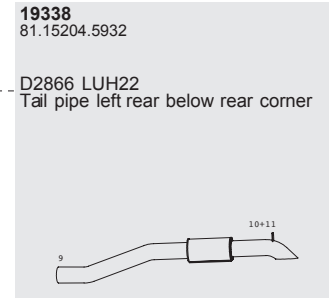

Mounting Parts

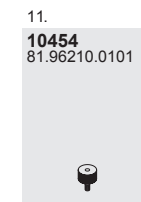
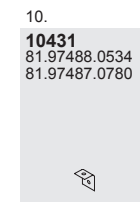
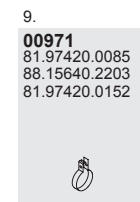
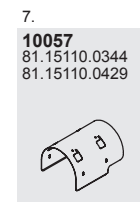
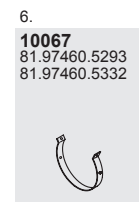
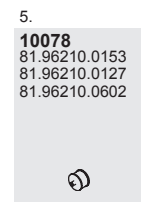

Series LION'S CITY/LION'S CITY UE/G/UELL/LL

Type

Euro III



A20
Lion's City UE
13/96 →

A21
Lion's City
22/96 →



A23
Lion's City G
34/96 →

A25
Lion's City UELL
08/98 →

A26
Lion's City LL
34/98 →

D2865 LUH
02/03/05-09
10,0l tr.
5 cyl.
191 KW/260 HP
198 KW/270 HP
228 KW/310 HP
235 KW/320 HP

D2866 LUH
01/02/20-30,
34-37,50-82
12,0l tr.
6 cyl.
191 KW/260 HP
228 KW/310 HP
257 KW/350 HP
265 KW/360 HP

Page 3/3
Previous page:
(syst.247000025)

Horizontal
LHD/RHD
Standard

Silencer

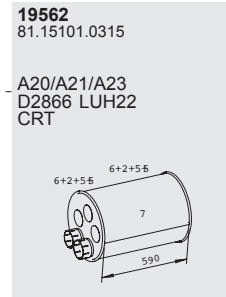
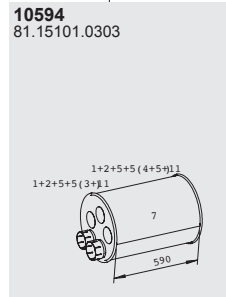

Tail pipe

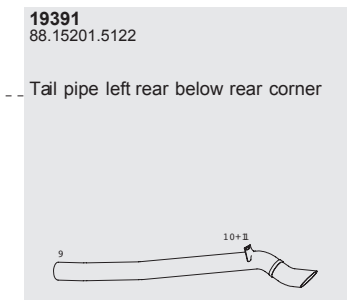
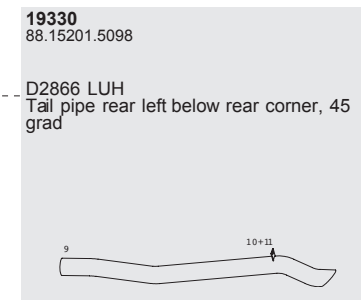
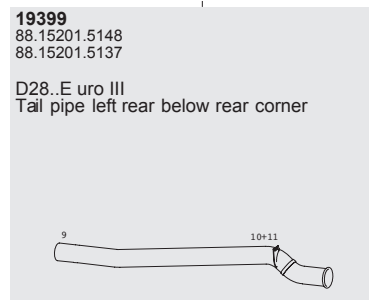
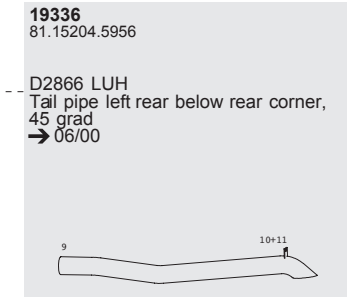
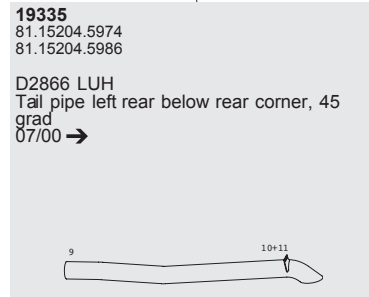

Mounting Parts

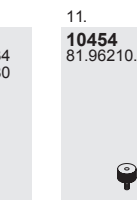
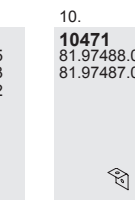
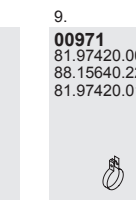
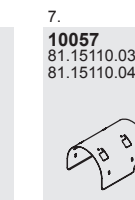
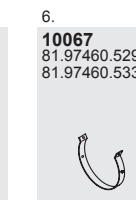
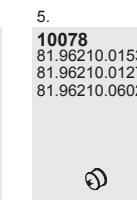
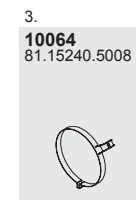
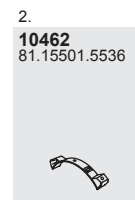
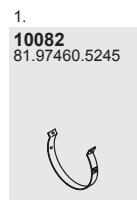

Series LION'S CITY/LION'S CITY UE/G/UELL/LL

Type

Euro II/III



A20
Lion's City UE
13/96 →
A21
Lion's City
22/96 →



A23
Lion's City G
34/96 →

A25
Lion's City UELL
08/98 →

A26
Lion's City LL
34/98 →

D2866 LUH
01/02/20-30,
34-37,50-52
12,0l tr.
6 cyl.
191 KW/260 HP
228 KW/310 HP
257 KW/350 HP
265 KW/360 HP

Page 1/3
Next page:
(syst.247000029)

Horizontal
LHD/RHD
Standard

Front pipe

19660
81.15205.5084

Euro III
Without OXI-CAT

19665
81.15204.5948

D2866 LUH21/16
CRT

14714
81.15204.5960

A20/A21
→ 02/00
CRT

19664
81.15205.5092
81.15204.5984

Euro III
A20/A21/A23W ith O XI -C AT
18/03 →

19669
81.15204.5980

A20/A21
03/00 →
CRT

19662
81.15204.5954

Silencer

10505
81.15101.0326

Without OXIC AT

19566
81.15101.0338

CRT

Mounting Parts

1.
10058
06.67410.3115

2.
10459
51.15901.0012
8.341.000.086

3.
10082
81.97460.5245

4.
10462
81.15501.5536

5.
10078
81.96210.0153
81.96210.0127
81.96210.0602

6.
10057
81.15110.0344
81.15110.0429

7.
10067
81.97460.5293
81.97460.5332

Series LION'S CITY/LION'S CITY UE/G/UELL/LL

Type

Euro II/III



A20
Lion's City UE
13/96 →

A21
Lion's City
22/96 →



A23
Lion's City G
34/96 →

A25
Lion's City UELL
08/98 →

A26
Lion's City LL
34/98 →

D2866 LUH
01/02/20-30,
34-37,50-52
12,0l tr.
6 cyl.
191 KW/260 HP
228 KW/310 HP
257 KW/350 HP
265 KW/360 HP

Page 2/3
Previous page:
(syst.247000028)

Horizontal
LHD/RHD
Standard

Silencer

Tail pipe

10505
81.15101.0326

Without OXIC AT

19332
81.15205.5006

Euro III
Tail pipe left rear below rear corner

19337
81.15204.5949

Tail pipe left rear below rear corner

19338
81.15204.5932

D2866 LUH22
Tail pipe left rear below rear corner

19566
81.15101.0338

CRT

19324
81.15204.5881

Tail pipe left rear below rear corner

19393
88.15201.5145
88.15201.5135

Euro III
Tail pipe left rear below rear corner, 45 grad

19334
88.15201.5092

Tail pipe left rear below rear corner

Mounting Parts

1.
10082
81.97460.5245

2.
10462
81.15501.5536

3.
10078
81.96210.0153
81.96210.0127
81.96210.0602

4.
10057
81.15110.0344
81.15110.0429

5.
10067
81.97460.5293
81.97460.5332

6.
00971
81.97420.0085
88.15640.2203
81.97420.0152

7.
10431
81.97488.0534
81.97487.0780

8.
10454
81.96210.0101

Series LION'S CITY/LION'S CITY UE/G/UELL/LL

Type

Euro II/III



A20
Lion's City UE
13/96 →
A21
Lion's City
22/96 →



A23
Lion's City G
34/96 →
A25
Lion's City UELL
08/98 →

A26
Lion's City LL
34/98 →

D2866 LUH
01/02/20-30,
34-37,50-52
12,0l tr.
6 cyl.
191 KW/260 HP
228 KW/310 HP
257 KW/350 HP
265 KW/360 HP

Page 3/3
Previous page:
(syst.247000028)

Horizontal
LHD/RHD
Standard

Silencer

Tail pipe

10505
81.15101.0326

Without OXIC AT

19335
81.15204.5974
81.15204.5986

Tail pipe left rear below rear corner, 45 grad
07/00 →

19390
88.15201.5153

Tail pipe by side panel

19336
81.15204.5956

Tail pipe left rear below rear corner, 45 grad
→ 06/00

19566
81.15101.0338

CRT

19339
88.15201.5148
88.15201.5137

Euro III
Tail pipe left rear below rear corner

19330
88.15201.5098

Tail pipe left rear below rear corner, 45 grad

19391
88.15201.5122

Tail pipe left rear below rear corner

Mounting Parts

1.
10082
81.97460.5245

2.
10462
81.15501.5536

3.
10078
81.96210.0153
81.96210.0127
81.96210.0602

4.
10057
81.15110.0344
81.15110.0429

5.
10067
81.97460.5293
81.97460.5332

6.
00971
81.97420.0085
88.15640.2203
81.97420.0152

7.
10431
81.97488.0534
81.97487.0780

8.
10454
81.96210.0101

Series LION'S CITY/LION'S CITY UE/G/UELL/LL

Type

Euro III
13/96 →



④X②

A39
Lion's City UE
13/96 →

A21
Lion's City
22/96 →

⑥X②

A23
Lion's City G
34/96 →
A25
Lion's City UELL
08/98 →

A26
Lion's City LL
34/98 →

🚛 **D2866 LUH**
01/02/20-30,
34-37,50-82
12,0l tr.
6 cyl.
191 KW/260 HP
228 KW/310 HP
257 KW/350 HP
265 KW/360 HP

Horizontal
LHD/RHD
Standard

Front pipe

14715
81.15205.5103



14627
81.15210.0094



Silencer

19565
81.15103.6002
81.15103.6004

DPF
Complete unit
Replaced to parts:5,6,7,8,9,10

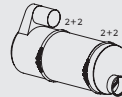

Tail pipe

19913
81.15205.5104

Tail pipe left rear below rear corner

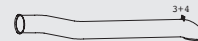

Mounting Parts

1.
00577
81.15103.0010



2.
10078
81.96210.0153
81.96210.0127
81.96210.0602



3.
10454
81.96210.0101



4.
10431
81.97488.0534
81.97487.0780



5. Inlet with CAT
19479
81.15103.0006



6. DPF
19885
81.15103.0016
81.15103.6016



7. Outlet
19462
81.15103.0007



8. Ring
19474
81.15103.0014



9. Gasket for Pos.
5+6, 6+7
19470
81.15103.0008



10. V-clamp for
Pos. 5+6, 6+7
94483



Series LION'S CITY/LION'S CITY UE/G/UELL/LL

Type

Euro III
13/96 →



④X②

A20
Lion's City UE
13/96 →

A21
Lion's City
22/96 →

⑥X②

A23
Lion's City G
34/96 →

A25
Lion's City UELL
08/98 →

A26
Lion's City LL
34/98 →

🚛 **D2866 LUH**
01/02/20-30,
34-37,50-82
12,0l tr.
6 cyl.
191 KW/260 HP
228 KW/310 HP
257 KW/350 HP
265 KW/360 HP

Horizontal
LHD/RHD
Standard

Front pipeT

14758
81.15205.5129

Silencer

19561
81.15103.6003

DPF
Complete unit
Replaced to parts:6,7,8,9,10,11

ail pipe

19954
81.15205.5128

Tail pipe left rear below rear corner

Mounting Parts

1.
10058
06.67410.3115

2.
10078
81.96210.0153
81.96210.0127
81.96210.0602

3.
00971
81.97420.0085
88.15640.2203
81.97420.0152

4.
10454
81.96210.0101

5.
10431
81.97488.0534
81.97487.0780

6. Inlet
10028
81.15103.0019

7. CAT
19887
81.15103.0020

8. DPF
19886
81.15230.0024

9. Outlet
10027
81.15103.0021

10. Gasket for Pos.
6+7, 7+8, 8+9
10018
81.15103.0022

11.V -clamp for
Pos. 6+7, 7+8, 8+9
94462
81.15103.0004

Series LION'S CLASSIC G

Type

Euro II/III
23/00 →



A75

D2866
LUH23/24/25,
27-30, 34/37,
50-52
12,0l tr.
6 cyl.
191 KW/260 HP
228 KW/310 HP
265 KW/360 HP
301 KW/410 HP

D2866
LUH20/21/22/26
12,0l tr.
6 cyl.
191 KW/260 HP
228 KW/310 HP
257 KW/350 HP

Front pipeT Silencer ail pipe

19675
83.15204.5532
83.15204.5525

Euro II

10594
81.15101.0303

19322
83.15204.5531
83.15204.5526

Euro II

14755
83.15204.5533

Euro III

AEM

19952
83.15201.5512

Euro III

Mounting Parts

1.
00981
81.97420.2017
83.97420.0500

2.
10082
81.97460.5245

3.
10462
81.15501.5536

4.
00971
81.97420.0085
88.15640.2203
81.97420.0152

5.
10454
81.96210.0101

Horizontal
LHD/RHD
Standard

Series LION'S CITY T

Type

Euro III
33/02 →



A78
Lion's City
T/TUERKEI

D0836
LOH01/02/03/04
7,0l tr.
6 cyl.
162 KW/220 HP
206 KW/280H P

D0836
LOH40/41/50
7,0l tr.
6 cyl.
177 KW/240 HP
206 KW/280H P

Front pipe

19671
81.15205.5039

Without CAT
D0836
LOH01/02/03/04

19777
81.15210.0022

N.A.

81.94289.2656
01.94015.2157

Without CAT
D0836 LOH

14757
81.15205.5139

D0836 LOH40/41/50

19685
81.15204.0476

D0836 LOH40/41/50

Silencer

19580
81.15101.0304

Tail pipe

19323
81.15204.0502

Mounting Parts

1.
00942
06.67041.0121
81.97420.0023
06.67041.0133

2.
10082
81.97460.5245

3.
00981
81.97420.2017
83.97420.0500

4.
10061
81.96210.0100

5.
00988
06.67041.0124
06.67043.0124
88.15640.0005

Horizontal
LHD/RHD
Standard

Series LION'S CLASSIC UE

Type

Euro III



A72
18/99 →

A74
11/00 →

D0826
LOH15/17/18/19
7,0l tr.
6 cyl.
162 KW/220 HP
191 KW/260 HP

D0836
LOH01/02/03/04
7,0l tr.
6 cyl.
162 KW/220 HP
206 KW/280 HP

Front pipe

19684
83.15201.5506



19777
81.15210.0022



19680
83.94289.0529
83.15201.0502



Silencer

19587
81.15101.0291
81.15101.0289

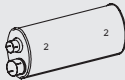

Tail pipe

19326
83.15201.5505



Mounting Parts

1.
00942
06.67041.0121
81.97420.0023
06.67041.0133



2.
28438
83.97460.5503



3.
00988
06.67041.0124
06.67043.0124
88.15640.0005



4.
10061
81.96210.0100



Horizontal
LHD/RHD
Standard

Series LION'S CLASSIC UE

Type

Euro II/III
18/99 →



A72

D0826
LOH15/17/18/19
7,0l tr.
6 cyl.
162 KW/220 HP
191 KW/260 HP

D0836
LOH01/02/03/04
7,0l tr.
6 cyl.
162 KW/220 HP
206 KW/280 HP

D2866
**LUH23-25,
27-30, 34-37,
50-52**
12,0l tr.
6 cyl.
191 KW/260 HP
228 KW/310 HP
265 KW/360 HP
301 KW/410 HP

Front pipe

47214
81.15205.5039

D0826 LOH
D0836 LOH

Without CAT.Converter

19777
81.15210.0022

D0826 LOH
D0836 LOH

N.A.

81.94289.2656
01.94015.2157

D0826 LOH
D0836 LOH

Silencer

19580
81.15101.0304

D0826 LOH
D0836 LOH

10594
81.15101.0303

D2866 LUH

Tail pipe

19326
83.15201.5505

D0826 LOH
D0836 LOH

19322
83.15204.5531
83.15204.5526

Euro II
D2866 LUH

19952
83.15201.5512

Euro III

19675
83.15204.5532
83.15204.5525

Euro II
D2866 LUH

14755
83.15204.5533

Euro III
D2866 LUH

AEM

Mounting Parts

1.
00981
81.97420.2017
83.97420.0500

2.
00942
06.67041.0121
81.97420.0023
06.67041.0133

3.
10082
81.97460.5245

4.
10462
81.15501.5536

5.
00988
06.67041.0124
06.67043.0124
88.15640.0005

6.
10061
81.96210.0100

7.
00971
81.97420.0085
88.15640.2203
81.97420.0152

8.
10454
81.96210.0101

Horizontal
LHD/RHD
Standard

Series LION'S CLASSIC UE

Type

Euro III
18/99 →



A72

D0836
LOH01/02/03/04
7,0l tr.
6 cyl.
162 KW/220 HP
206 KW/280 HP

Front pipeT

14728
83..15201.5522

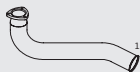

Silencer

19561
81.15103.6003

DPF
Complete unit
Replaced to parts:4,5,6,7,8,9

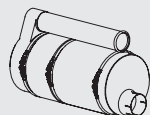

ail pipe

19916
83.15201.5515



Mounting Parts

1.
10058
06.67410.3115



2.
00971
81.97420.0085
88.15640.2203
81.97420.0152



3.
10454
81.96210.0101



4. Inlet
10028
81.15103.0019



5. CAT
19887
81.15103.0020



6. DPF
19886
81.15230.0024



7. Outlet
10027
81.15103.0021



8. Gasket for Pos.
4+5, 5+6, 6+7
10018
81.15103.0022



9. V-clamp for Pos.
4+5, 5+6, 6+7
94462
81.15103.0004



Horizontal
LHD/RHD
Standard

Series LION'S COACH

Type

Euro III
24/00 →



④X②
⑥X②

R07
Lion's Coach

R08
Lion's Coach L

☞ **D2866 LOH**
12,0l tr.
6 cyl.
228 KW/310 HP
265 KW/360 HP
310 KW/410 HP

☞ **D2876 LOH**
13,0l tr.
6 cyl.
338 KW/460 HP

Front pipeT

Silencer

ail pipe

14763
81.15205.5009

AEM



14681
81.15205.5015

AEM



10599
81.15101.0293
81.15101.0341

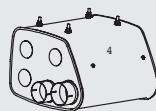

19957
81.15205.5034
81.15205.5010

INOX

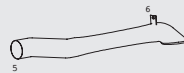

Mounting Parts

1.
19471
88.98105.0010



2.
10050
06.67419.0004
88.97445.0015



3. 25/02 →
00971
81.97420.0085
88.15640.2203
81.97420.0152



3. → 25/02
19447
88.15640.0007
88.15640.2203



4.
10493
81.15110.0296



5.
10073
81.97420.5045
81.97420.0076



6.
10454
81.96210.0101



Horizontal
LHD/RHD
Standard

Series LION'S STAR

Type

Euro III
24/00 →



R02
Lion's Star

R03
Lion's Star L

D2866 LOH
12,0l tr.
6 cyl.
228 KW/310 HP
265 KW/360 HP
310 KW/410 HP

D2876 LOH
13,0l tr.
6 cyl.
338 KW/460 HP
353 KW/480 HP

Front pipeT

14763
81.15205.5009

AEM



14681
81.15205.5015

AEM



Silencer

10599
81.15101.0293
81.15101.0341

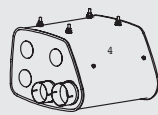

ail pipe

19957
81.15205.5034
81.15205.5010

INOX

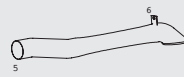

Mounting Parts

1.
19471
88.98105.0010



2.
10050
06.67419.0004
88.97445.0015



3. → 25/02
00971
81.97420.0085
88.15640.2203
81.97420.0152



3. 25/02 →
19447
88.15640.0007
88.15640.2203



4.
10493
81.15110.0296



5.
10073
81.97420.5045
81.97420.0076



6.
10454
81.96210.0101



Horizontal
LHD/RHD
Standard

Series ND 202

Type

Euro II
19/95 →



A11
ND 202

D2865 LUH07
10,0l tr.
5 cyl.
191 KW/260 HP

D2865 LUH09
10,0l tr.
5 cyl.
228 KW/310 HP

Front pipeT

19771
81.15204.5735

Silencer

10531
81.15101.0274
81.15101.0236

ail pipe

19384
81.15204.5736

Mounting Parts

1.
10459
51.15901.0012
8.341.000.086

2.
00961
81.97420.0157
81.97420.0062

3.
10426
81.15502.5092

4.
10425
81.15502.5093

5.
00968
81.97420.0076

Horizontal
LHD
Standard

Series ND 202

Type

Euro II
19/93 →



A14
ND202

D0826
LUH/LUH213
7,0l tr.
6 cyl.
157 KW/213 HP

D0826
LUH01-06/
08/10/12/13
7,0l tr.
6 cyl.
162 KW/220 HP
169 KW/230 HP
191 KW/260 HP
198 KW/270 HP

Horizontal
LHD
Standard

Front pipe

10769
81.15204.5764

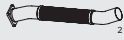

Silencer

10559
81.15101.0250
81.15101.0238

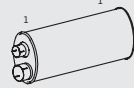

Tail pipe

10986
81.15204.5766

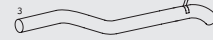

Mounting Parts

1.
28438
83.97460.5503



2.
00942
06.67041.0121
81.97420.0023
06.67041.0133



3.
00901
81.97420.0140
06.67041.0125
85.15640.0001



Series NG 242/272

Type

Euro I
18/89 → 05/93



896
NG 242
NG 272

D0826
LUH/LUH213
7,0l tr.
6 cyl.
157 KW/213 HP

D0826
LUH01-06/
08/10/12/13
7,0l tr.
6 cyl.
162 KW/220 HP
169 KW/230 HP
191 KW/260 HP
198 KW/270 HP

Horizontal
LHD
Standard

Front pipe

10691
81.15204.0411
81.15204.5552



10692
81.15204.5553



Silencer

10559
81.15101.0250
81.15101.0238

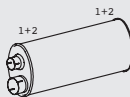

Tail pipe

10301
88.15204.5525
81.15204.5525



Mounting Parts

1.
10417
81.15502.5079
81.15501.6023
81.15502.5120



2.
10089
81.96210.0052



3.
00942
06.67041.0121
81.97420.0023
06.67041.0133



4.
00901
81.97420.0140
06.67041.0125
85.15640.0001



5.
10454
81.96210.0101



Series NG 263/313 F

Type

Euro III
32/97 →



A24
NG 263 F
NG 313 F

D2866
LUH20-30/
34-37/50-52

12,0l tr.
6 cyl.
191 KW/260 HP
228 KW/310 HP
257 KW/350 HP
265 KW/360 HP
301 KW/410 HP

Front pipeT

Silencer

ail pipe

19668
81.15204.5880

10594
81.15101.0303

19324
81.15204.5881

Tail pipe left rear
below rear corner

19331
81.15204.5991

Tail pipe left rear
below rear corner

19394
88.15201.5149

Tail pipe left rear
below rear corner

19665
81.15204.5948

10505
81.15101.0326

19337
81.15204.5949

Tail pipe left rear
below rear corner

19332
81.15205.5006

Tail pipe left rear
below rear corner

19664
81.15205.5092
81.15204.5984

Mounting Parts

1.
00981
81.97420.2017
83.97420.0500

2.
10462
81.15501.5536

3.
10078
81.96210.0153
81.96210.0127
81.96210.0602

4.
10082
81.97460.5245

5.
10057
81.15110.0344
81.15110.0429

6.
10476
51.15901.0009
51.15901.0012

7.
10058
06.67410.3115

8.
10067
81.97460.5293
81.97460.5332

9.
00971
81.97420.0085
88.15640.2203
81.97420.0152

10.
10431
81.97488.0534
81.97487.0780

11.
10454
81.96210.0101

Horizontal
LHD
Standard

Series NM 152

Type

Euro II
33/91 →



A05
Midi Bus

33/91 →
000-A05

35/93 →
020-P31

D0824
LOH01-05
4,6l tr.
4 cyl.
114K W/155 HP

Front pipe

10798
81.15204.5695



10796
81.15204.5696



Silencer

10534
81.15101.0251

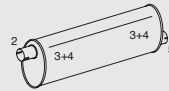

Tail pipe

10987
81.15204.5697



Mounting Parts

1.
00948
81.97420.0026
81.97420.0062



2.
00942
06.67041.0121
81.97420.0023
06.67041.0133



3.
10089
81.96210.0052



4.
10417
81.15502.5079
81.15501.6023
81.15502.5120



5.
00901
81.97420.0140
06.67041.0125
85.15640.0001



Horizontal
LHD
Standard

Series NL 202

Type

Euro I
19/89 → 11/93



895
NL 202
898
NL 202F

D0826
LUH/LUH213
7,0l tr.
6 cyl.
157 KW/213 HP

D0826
LUH01-06/
08/10/12/13
7,0l tr.
6 cyl.
162 KW/220 HP
169 KW/230 HP
191 KW/260 HP
198 KW/270 HP

Horizontal
LHD
Standard

Front pipe

10691
81.15204.0411
81.15204.5552



10692
81.15204.5553



Silencer

10559
81.15101.0250
81.15101.0238

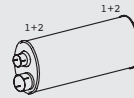

Tail pipe

10301
88.15204.5525
81.15204.5525



Mounting Parts

1.
10417
81.15502.5079
81.15501.6023
81.15502.5120



2.
10089
81.96210.0052



3.
00942
06.67041.0121
81.97420.0023
06.67041.0133



4.
00901
81.97420.0140
06.67041.0125
85.15640.0001



5.
10454
81.96210.0101



Series NL 202/222/272/312

Type

Euro II
10/95 →



A10
NL 202
NL 222
NL 272
NL 312

D2865 LUH07
10,0l tr.
5 cyl.
191 KW/260 HP

D2865 LUH09
10,0l tr.
5 cyl.
228 KW/310 HP

Front pipeT

19771
81.15204.5735



Silencer

10531
81.15101.0274
81.15101.0236

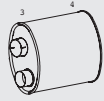

ail pipe

19384
81.15204.5736



Mounting Parts

1.
10459
51.15901.0012
8.341.000.086



2.
00961
81.97420.0157
81.97420.0062



3.
10426
81.15502.5092



4.
10425
81.15502.5093



5.
00968
81.97420.0076



Horizontal
LHD
Standard

Series NL 223/263/313 F

Type

Euro III
25/96 → 02/00



A22
NL 223 F
NL 263 F
NL 313 F

D0826 LUH
7,0l tr.
6 cyl.
157 KW/213 HP
162 KW/220 HP
191 KW/260 HP

Front pipeT

Silencer

ail pipe

19674
81.15204.5853

→ 14/97

19580
81.15101.0304

19329
88.15201.5095

Tail pipe left rear
below rear corner

19666
81.15204.5883

19320
81.15204.5884

Tail pipe left rear
below rear corner

Mounting Parts

1.
00942
06.67041.0121
81.97420.0023
06.67041.0133

2.
10454
81.96210.0101

3.
10078
81.96210.0153
81.96210.0127
81.96210.0602

4.
10462
81.15501.5536

5.
10082
81.97460.5245

6.
10057
81.15110.0344
81.15110.0429

7.
00981
81.97420.2017
83.97420.0500

8.
10431
81.97488.0534
81.97487.0780

Horizontal
LHD
Standard

Series NL 223/263/313 F

Type

Euro II
→ 02/00



A22
NL 223 F
NL 263 F
NL 313 F

D2866 LUH
12,0l tr.
6 cyl.
191 KW/260 HP
228 KW/310 HP

Front pipeT

19668
81.15204.5880

Silencer

10594
81.15101.0303

ail pipe

19324
81.15204.5881

Tail pipe left rear below rear corner

19334
88.15201.5092

Tail pipe left rear below rear corner

Mounting Parts

1.
00981
81.97420.2017
83.97420.0500

2.
10462
81.15501.5536

3.
10078
81.96210.0153
81.96210.0127
81.96210.0602

4.
10082
81.97460.5245

5.
10057
81.15110.0344
81.15110.0429

6.
10476
51.15901.0009
51.15901.0012

7.
00971
81.97420.0085
88.15640.2203
81.97420.0152

8.
10431
81.97488.0534
81.97487.0780

9.
10454
81.96210.0101

Horizontal
LHD
Standard

Series NL 223/263/313 F

Type

Euro III
03/00 →



A22
NL 223 F
NL 263 F
NL 313 F

D0826/36 LUH
7,0l tr.
6 cyl.
162 KW/220 HP
191 KW/260 HP

D2866 LUH
12,0l tr.
6 cyl.
191 KW/260 HP
228 KW/310 HP

Front pipeT

Silencer

ail pipe

19664
81.15205.5092
81.15204.5984

D2866 LUH

10505
81.15101.0326

19337
81.15204.5949

Tail pipe left rear
below rear corner

19339
81.15204.5991

Tail pipe left rear
below rear corner

19665
81.15205.5031

D2866 LUH
Tail pipe left rear
below rear corner

19666
81.15204.5948

D2866 LUH

19336
81.15204.5956

D2866 LUH
Tail pipe left rear
below rear corner

19332
81.15205.5006

D2866 LUH
Tail pipe left rear
below rear corner

19394
88.15201.5149

D2866 LUH
Tail pipe left rear
below rear corner

19669
81.15204.5980

D0826/36

19335
81.15204.5974
81.15204.5986

D2866 LUH
Tail pipe left rear
below rear corner

19333
81.15205.5019

D2866 LUH
Tail pipe left rear
below rear corner

Mounting Parts

1.
10476
51.15901.0009
51.15901.0012

2.
10058
06.67410.3115

3.
10462
81.15501.5536

4.
10078
81.96210.0153
81.96210.0127
81.96210.0602

5.
10067
81.97460.5293
81.97460.5332

6.
10057
81.15110.0344
81.15110.0429

7.
00971
81.97420.0085
88.15640.2203
81.97420.0152

8.
10431
81.97488.0534
81.97487.0780

9.
10454
81.96210.0101

Horizontal
LHD
Standard

Series RUE 280

Type

→ 35/83



4X2

597

D2566 MTUH
11,5 ltr.
6 cyl.
206 KW/280 HP

Front pipe

10727
81.15202.5279



10689
81.15202.0054



10619
81.15210.0033



10726
81.15202.5495



Silencer

10558
81.15101.0054

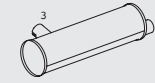

Tail pipe

10320
81.15202.6028
81.15202.5465

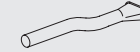

Mounting Parts

1.
10476
51.15901.0009
51.15901.0012



2.
10076
81.98112.0044



3.
00669



4.
00978
88.15640.0000
81.97420.0073



Horizontal
LHD
Standard

Series SG 242

Type

10/85 →



⑥X②

793
SG242

D2866 UH
12,0l tr.
6 cyl.
177 KW/240 HP

Front pipe

Silencer

Tail pipe

10638
81.15210.0043

(x2 pcs.)
→ 27/90



10620
81.15204.5304

→ 27/90



10520
81.15101.0164

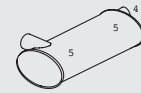

10343
81.15204.6017

31/89 →

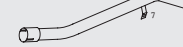

10636
81.15204.5588

28/90 →



Mounting Parts

1.
00995
81.97420.2000



2.
00948
81.97420.0026
81.97420.0062



3.
00981
81.97420.2017
83.97420.0500



4.
00988
06.67041.0124
06.67043.0124
88.15640.0005



5.
10487
81.15501.5143



6.
10454
81.96210.0101



Horizontal
LHD
Standard

Series SG 242

Type

24/84 → 12/90



795
SG242
SG242H

D2866 UH
12,0l tr.
6 cyl.
177 KW/240 HP

Front pipe

Silencer

10633
81.15204.5144



10634
81.15210.0056



10536
81.15101.0161

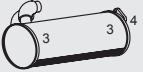

Mounting Parts

1.
10453
81.98701.0014



2.
00942
06.67041.0121
81.97420.0023
06.67041.0133



3.
10487
81.15501.5143



4.
10088
81.15901.0006
81.96601.0551



Horizontal
LHD
Standard

Series SG 292

Type

02/89 →



©X0

793
SG292

D2866 TUH
12,0l tr.
6 cyl.
213 KW/290 HP

Front pipeT

Silencer

ail pipe

10632
81.15204.5580

28/90 →



10535
81.15101.0199

28/90 →

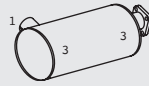

10340
81.15204.5582

28/90 →



10538
81.15101.0176

02/89 → 27/90

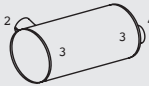

Mounting Parts

1.
00971
81.97420.0085
88.15640.2203
81.97420.0152



2.
00961
81.97420.0157
81.97420.0062



3.
10487
81.15501.5143



4.
00978
88.15640.0000
81.97420.0073



5.
10454
81.96210.0101



Horizontal
LHD
Standard

Series **SL 202**

Type

22/85 →



4X2

791
SL202

D2566 UH/200
11,5 ltr.
6 cyl.
147 KW/200 HP

D2866 UH/UM/UM01
12,0l tr.
6 cyl.
152 KW/206 HP
177 KW/240 HP

Horizontal
LHD
Standard

Front pipe

Silencer

Tail pipe

10638
81.15210.0043

(x2 pcs.)
22/85 → 27/90
Auto

10620
81.15204.5304

10520
81.15101.0164

10343
81.15204.6017

31/89 →

10755
81.15210.0054

(x2 pcs.)
22/85 → 27/90, Manual
10/87 → 01/90, Auto (Renk D873)

10614
81.15204.5589

28/90 →
Manual

10636
81.15204.5588

28/90 →
Auto

Mounting Parts

1.
00992
06.67041.0119

2.
00948
81.97420.0026
81.97420.0062

3.
00981
81.97420.2017
83.97420.0500

4.
00988
06.67041.0124
06.67043.0124
88.15640.0005

5.
10487
81.15501.5143

6.
10454
81.96210.0101

Series **SL 202**

Type

Euro I
19/84 → 21/96



791
SL202

D2866
12,0l tr.
6 cyl.
213 KW/290 HP

Front pipe

Silencer

Tail pipe

10632
81.15204.5580

28/90 →



10535
81.15101.0199

28/90 →

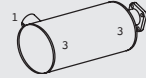

10340
81.15204.5582

28/90 →

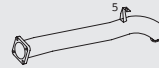

10538
81.15101.0176

→ 27/90

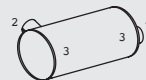

Mounting Parts

1.
00971
81.97420.0085
88.15640.2203
81.97420.0152



2.
00961
81.97420.0157
81.97420.0062



3.
10487
81.15501.5143



4.
00978
88.15640.0000
81.97420.0073



5.
10454
81.96210.0101



Horizontal
LHD
Standard

Series **SL 18.220/260/280 HOCL/R**

Type

Euro IV
07/03 →



A89
F-TUERKEI

D0836 LUH
7,0l tr.
6 cyl.
206 KW/280 HP

D2066 LUH
10,5l tr.
6 cyl.
257 KW/350 HP

Front pipe

14743
81.15205.5196

AEM insulation

10743
81.15210.0071

14679
81.15205.5197

Silencer

19568
81.15101.0382

CAT

Tail pipe

19963
81.15205.5198

Mounting Parts

1.
00981
81.97420.2017
83.97420.0500

2.
10058
06.67410.3115

3.
00971
81.97420.0085
88.15640.2203
81.97420.0152

4.
10431
81.97488.0534
81.97487.0780

5.
10454
81.96210.0101

6.
10067
81.97460.5293
81.97460.5332

Horizontal
LHD/RHD
Standard

Series SR 280

Type

→ 35/83



4X2

197
SR280

D2566
11,5 ltr.
6 cyl.
206 KW/280 HP

Front pipe

10727
81.15202.5279

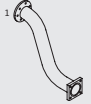

10689
81.15202.0054



10619
81.15210.0033



10726
81.15202.5495



Silencer

10558
81.15101.0054



Tail pipe

10320
81.15202.6028
81.15202.5465

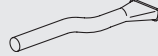

Mounting Parts

1.
10476
51.15901.0009
51.15901.0012



2.
10076
81.98112.0044



3.
00669



4.
00978
88.15640.0000
81.97420.0073



Horizontal
LHD
Standard

Series SUE 242

Type

16/87 →



4X2

888
SUE242

D2866
UH/UM/UM01
12,0l tr.
6 cyl.
150 KW/200 HP
177 KW/240 HP

Horizontal
LHD
Standard

Front pipe

10638
81.15210.0043

(x2 pcs.)
22/85 → 27/90
Auto

10755
81.15210.0054

(x2 pcs.)
22/85 → 27/90, Manual
10/87 → 01/90, Auto (Renk D873)

10620
81.15204.5304

10614
81.15204.5589

28/90 →
Manual

10636
81.15204.5588

28/90 →
Auto

Silencer

10520
81.15101.0164

Tail pipe

10343
81.15204.6017

31/89 →

Mounting Parts

1.
00992
06.67041.0119

2.
00942
81.97420.0026
81.97420.0062

3.
00981
81.97420.2017
83.97420.0500

4.
00988
06.67041.0124
06.67043.0124
88.15640.0005

5.
00487
81.15501.5143

6.
10454
81.96210.0101

Series SUE 280

Type

31/82 → 12/90



4X2

789
SUE 280

D2566 MTUH
11,5 ltr.
6 cyl.
206 KW/280 HP

Front pipe

10619
81.15210.0033



N.A.
81.15204.5108

Silencer

10558
81.15101.0054



Tail pipe

N.A.
81.15204.5107

Mounting Parts

1.
00948
81.97420.0026
81.97420.0062



2.
00961
81.97420.0157
81.97420.0062



3.
00978
88.15640.0000
81.97420.0073



Horizontal
LHD
Standard

Series UEL 242/272/292

Type

Euro I
06/90 →



893
UEL 242
UEL 272
UEL 292

D2865
LUH02/03/05-09
10,0l tr.
5 cyl.
198 KW/270 HP

D2866 TUH/
TUH01/TUM
12,0l tr.
6 cyl.
177 KW/240 HP
213 KW/290 HP

Front pipe

Silencer

Tail pipe

10630
81.15204.5370

10697
81.15204.5384
81.15204.5474

10535
81.15101.0199

10306
81.15204.5359

10760
81.15204.5659

D2865 LUH

19368
81.15204.5760

19723
81.15204.5762

D2865 LUH

Mounting Parts

1.
10459
51.15901.0012
8.341.000.086

2.
00971
81.97420.0085
88.15640.2203
81.97420.0152

3.
10487
81.15501.5143

4.
10087
81.15901.0020
81.96601.0553

5.
10454
81.96210.0101

Horizontal
LHD
Standard

Series UEL 242/272/292

Type

Euro I
06/90 → 31/93



893
UEL 242

D2866 UH/
UM/UM01
12,0l tr.
6 cyl.
177 KW/240 HP

Front pipe

Silencer

Tail pipe

19729
81.15204.5537



19589
81.15101.0237



19370
81.15204.6024



Mounting Parts

1.
00971
81.97420.0085
88.15640.2203
81.97420.0152



2.
10487
81.15501.5143



3.
00988
06.67041.0124
06.67043.0124
88.15640.0005



4.
10454
81.96210.0101



Horizontal
LHD
Standard

Series UEL 313/353

Type

Euro III
19/99 → 23/05



A01
A04

D0866 LUH
12,0l tr.
6 cyl.
228 KW/310 HP
257 KW/350 HP

Front pipeT

Silencer

ail pipe

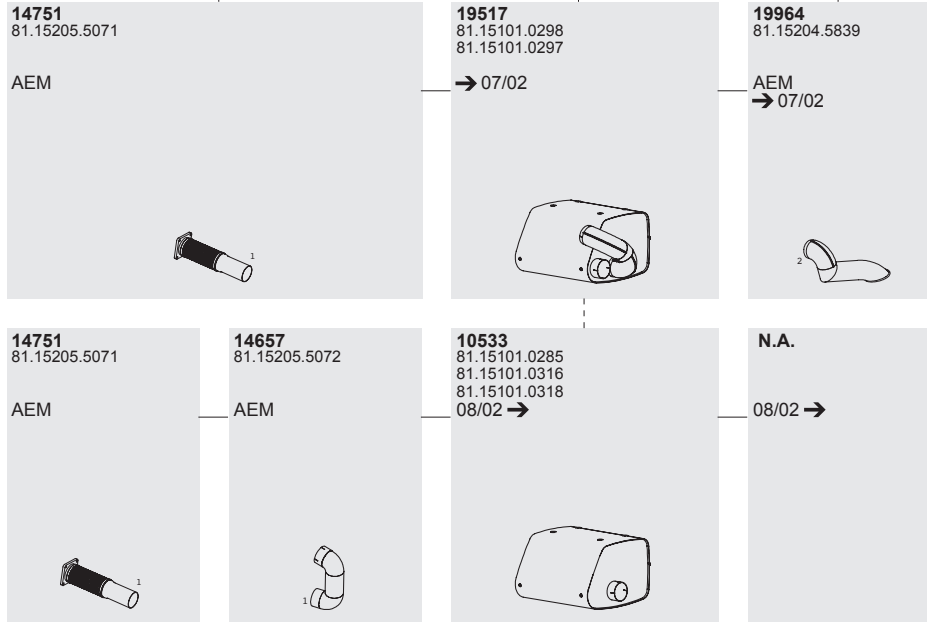

Mounting Parts

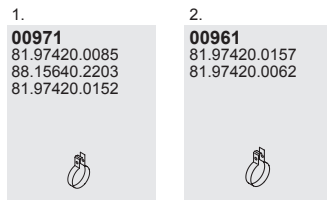

Horizontal
LHD/RHD
Standard

SOYLU / OTOBÜS

MERCEDES

1

608 D	177	814 D	199
609 D	178	817 F	200
613 D	179	Citaro	201
709	182	Conecto	211
709 D	185	Integro	214
709 K	186	Intouro	216
711 D	189	O 301	217
809	190	O 302	221
809 D	193	O 303	222
809 DT	194	O 304	242
809 K	195	O 305	244
811 D/DK	198	O 305 G	247

MERCEDES

2



O 307	250	O 405 GTD	285
O 309 D	253	O 405 N	286
O 330	266	O 405 NU	287
O 340	267	O 405 ST	288
O 350	269	O 407	291
O 402	271	O 407 UE	292
O 404	274	O 408	294
O 405	278	O 814	295
O 405 G	280	O 814 F	297
O 405 GN	283	O 817	299
O 405 GT	284	O 817 L	300

SOYLU / OTOBÜS

MERCEDES

3

O 1114	302	OH 1625 L	321
O 1114 L	303	OH 1627	322
O 1117	304	OH 1628	323
O 1117 L	305	OH 1628 L	324
O 1120	308	Sprinter	325
O 1120 L	314	Tourismo	347
OH 1622	316	Touro	352
OH 1622 L	318	Travego	353
OH 1625	320	Vario	358

Series 608 D

Type 608 D
 Baumuster 310.429

Front pipe

Silencer

Tail pipe

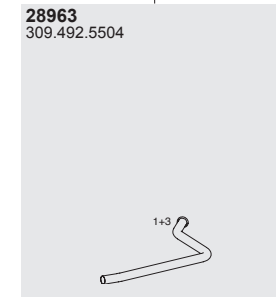
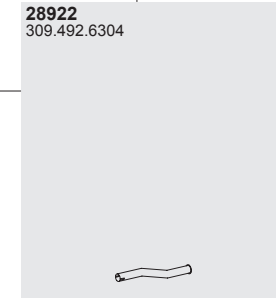
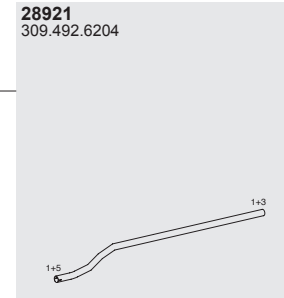
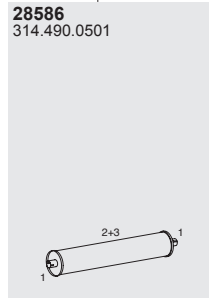
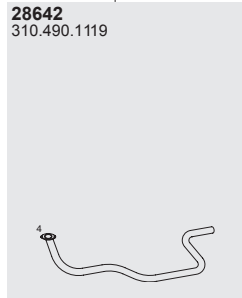

Mounting Parts

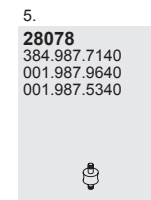
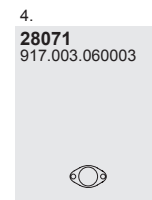
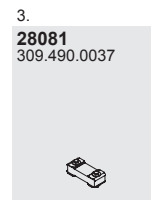
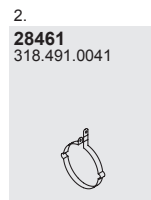
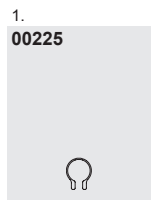

Horizontal
 LHD
 Standard

Series 609 D

Type

609 D
WB 3150, 3700,
4250

Baumuster

668.001
668.002
668.003
668.041
668.042
668.061
668.062
668.063

Front pipe

25641
668.490.2519

18998 ▶CHno



25780
668.490.0410

18998 ▶CHno



28603
668.490.0719

▶CHno 18997

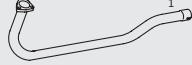

Silencer

28563
383.490.0201
673.490.0001

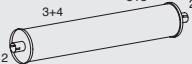

Tail pipe

28932
668.492.2804



Mounting Parts

1.
27412
668.492.1540
668.492.1440
668.492.0740



2.
28063
673.492.0140
313.392.0340



3.
28425
668.492.2140
668.490.0241



4.
28076
667.490.0037



5.
00992
071.555.075.502



6.
27415
668.492.0641



7.
28012
668.492.0340



8.
28078
384.987.7140
001.987.9640
001.987.5340



Horizontal
LHD
Standard

Series 613 D

Type

613 D
 WB 3500, 4100
 ►CHno352.290
 Excl. 350.368,
 793, 843, 954,
 351.074, 169,
 284, 434, 903,
 352.271, 272
 Incl. 352.759,
 353.163, 868,
 354.161

Baumuster

313.402
 313.404
 313.424
 313.427

Front pipe

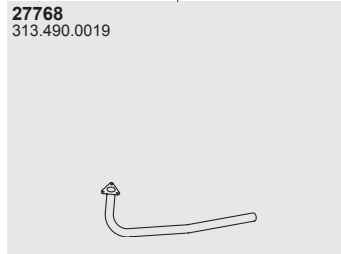

Silencer

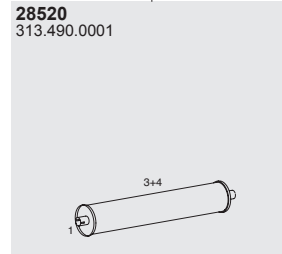

Tail pipe

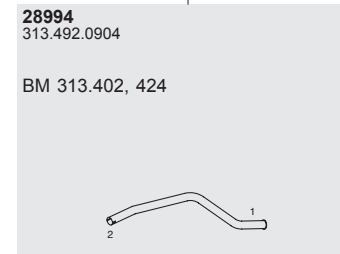
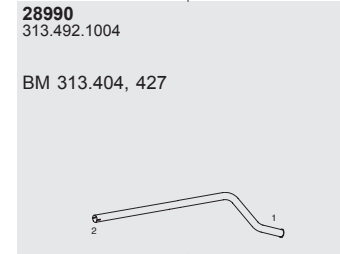

Mounting Parts

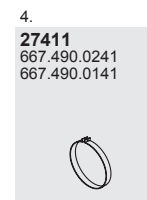
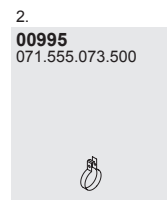
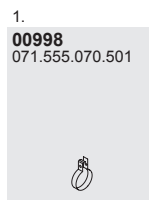

Horizontal
 LHD
 Standard

Series 613 D

Type

613 D
 WB 3500, 4100
 352.291 ►CHno
 564.535
 Incl. 350.368,
 793, 843, 954,
 351.074, 169,
 284, 434, 903,
 352.271, 272
 Excl. 352.759,
 353.163, 868,
 354.161

Baumuster

313.402
 313.404
 313.424
 313.427

Front pipe

28943
 313.490.0219



Silencer

28520
 313.490.0001

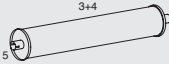

N.A.
 313.492.1204
 BM 313.404, 427

28946
 313.492.1504



Tail pipe

28941
 313.492.1704



28948
 313.492.1104



N.A.
 313.492.1604
 BM 313.402, 424

Mounting Parts

1.
00995
 071.555.073.500



2.
28072
 312.492.1080
 442.492.0280



3.
28081
 309.490.0037



4.
27411
 667.490.0241
 667.490.0141



5.
00998
 071.555.070.501



Horizontal
 LHD
 Standard

Series 613 D

Type	Baumuster
613 D	313.402
WB 3500, 4100	313.404
	313.424
564.536 ▶CHno	313.427
	313.429

Front pipe

Silencer

Tail pipe

27767
313.490.0319



28520
313.490.0001

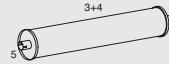

28943
313.492.2604

BM 313.404, 427



28946
313.492.1504

BM 313.404, 427



28941
313.492.1704



Mounting Parts

1.
00992
071.555.075.502



2.
28072
312.492.1080
442.492.0280



3.
28081
309.490.0037



4.
28461
318.491.0041



5.
00998
071.555.070.501



Horizontal
LHD
Standard

Series 709

Type Baumuster

709 673.001
 673.002
 WB 3090, 3640, 673.003
 4190

►CHno5.152.276

Front pipe

Silencer

Tail pipe

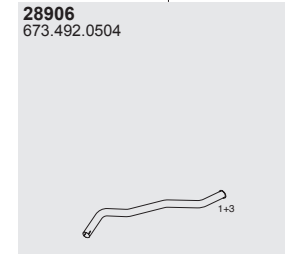
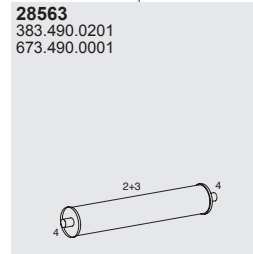
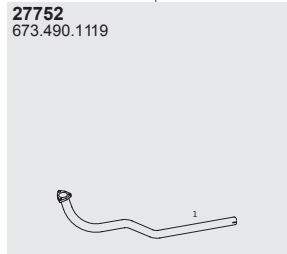

Mounting Parts

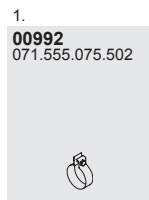

Horizontal
LHD
Standard

Series 709

Type Baumuster

Euro I 673.001
 673.002
 709 673.003
 WB 3090, 3640,
 4190
 5.152.277 ▶CHno
 5.325.174

Front pipe



Silencer

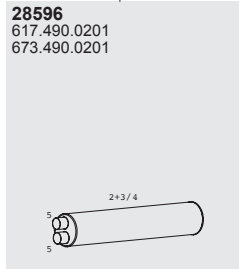

Tail pipe



Mounting Parts

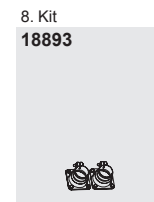
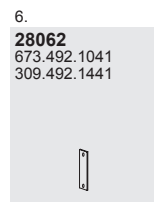
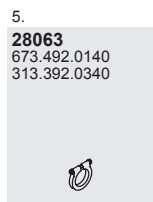
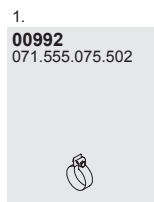

Horizontal
 LHD
 Standard

Series 709

Type

Euro I

709

WB 3090, 3640,
4190

5.325.175 ▶CHno

Baumuster

673.001

673.002

673.003

Front pipe

26792
673.490.3119

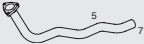

26793
670.492.0401
670.490.0065
673.490.0065



Silencer

28596
617.490.0201
673.490.0201

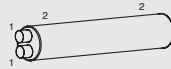

Tail pipe

26392
673.492.2604

5.325.175 ▶CHno 5.743.552



26399
673.492.4804
673.492.4404

5.743.553 ▶CHno



Mounting Parts

1.
28063
673.492.0140
313.392.0340



2.
28422
673.491.2241
673.491.1141



3.
28078
384.987.7140
001.987.9640
001.987.5340



4. ▶CHno 5.743.552
28062
673.492.1041
309.492.1441



5.
00992
071.555.075.502



6. ▶CHno 5.743.552
28081
309.490.0037



7.
00994
071.555.078.502



Horizontal
LHD
Standard

Series 709 D

Type

709 D
WB 3150, 3500,
3700, 4250

Baumuster

669.000
669.001
669.002
669.003
669.041
669.042
669.061
669.062
669.063

Front pipe

25641
668.490.2519

18998 ▶CHno



25780
668.490.0410

18998 ▶CHno



Silencer

28563
383.490.0201
673.490.0001

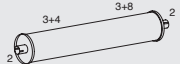

Tail pipe

28932
668.492.2804



28603
668.490.0719

▶CHno 18997



Mounting Parts

1.
27412
668.492.1540
668.492.1440
668.492.0740



2.
28063
673.492.0140
313.392.0340



3.
28425
668.492.2140
668.490.0241



4.
28076
667.490.0037



5.
00992
071.555.075.502



6.
27415
668.492.0641



7.
28012
668.492.0340



8.
28078
384.987.7140
001.987.9640
001.987.5340



Horizontal
LHD
Standard

Series 709 K

Type
Euro I
709 K
WB 3090
►CHno5.152.276

Baumuster
673.040

Front pipe

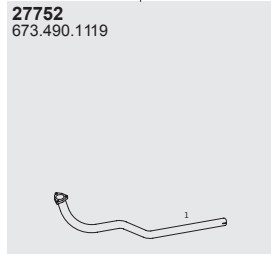

Silencer

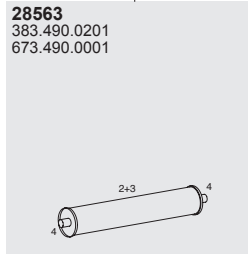

Tail pipe



Mounting Parts

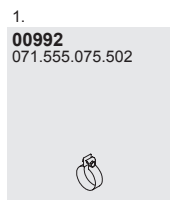







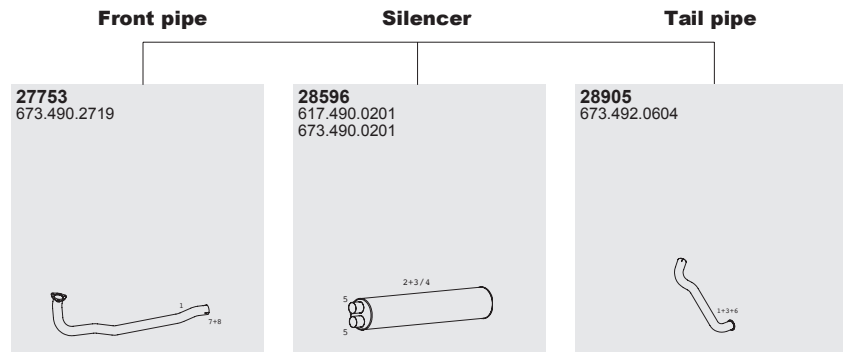

Horizontal
LHD
Standard

Series 709 K

Type	Baumuster
Euro I	673.040
709 K	
WB 3090	
5.152.277 ▶CHno	
5.325.174	



Mounting Parts

<p>1. 00992 071.555.075.502</p> 	<p>2. 28467 617.491.0440</p> 	<p>3. ▶CHno 5.194.472 28081 309.490.0037</p> 	<p>4. 5.194.473 ▶CHno 28480 381.492.0082 301.492.0382 0201.175.00</p> 	<p>5. 28063 673.492.0140 313.392.0340</p> 	<p>6. 28062 673.492.1041 309.492.1441</p> 	<p>7. CAT.retrofit 18573</p> 	<p>8. Kit 18893</p> 
--	---	---	--	--	--	---	--

Horizontal
LHD
Standard

Series 709 K

Type
Euro I
709 K
WB 3090
5.325.175 ▶CHno

Baumuster
673.040

Front pipe

26792
673.490.3119



26793
670.492.0401
670.490.0065
673.490.0065



Silencer

28596
617.490.0201
673.490.0201

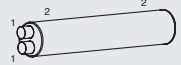

Tail pipe

26393
673.492.2704

5.325.175 ▶CHno 5.743.552



26399
673.492.4804
673.492.4404

5.743.553 ▶CHno



Mounting Parts

1.
28063
673.492.0140
313.392.0340



2.
28422
673.491.2241
673.491.1141



3.
28078
384.987.7140
001.987.9640
001.987.5340



4. ▶CHno 5.743.552
28062
673.492.1041
309.492.1441



5.
00992
071.555.075.502



6. ▶CHno 5.743.552
28081
309.490.0037



7.
00994
071.555.078.502



Horizontal
LHD
Standard

Series 711 D

Type	Baumuster
Euro I	669.301
	669.302
711D	669.303
	669.361
WB 3150, 3700, 4250	669.362
	669.363

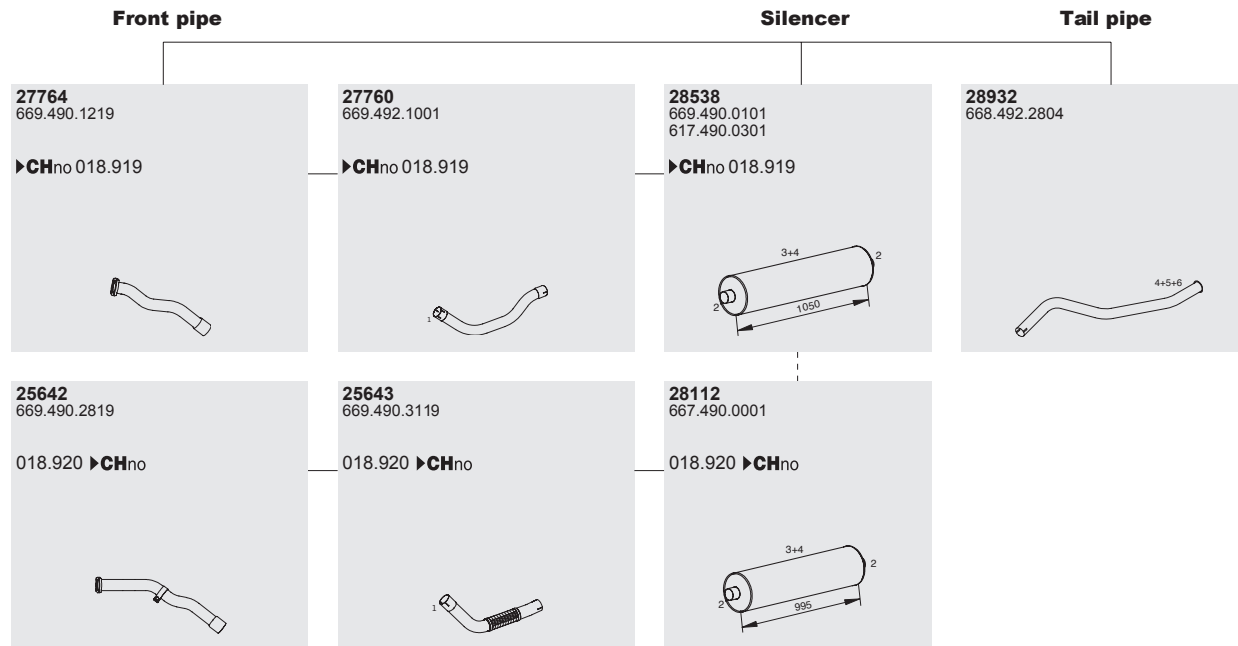

Mounting Parts

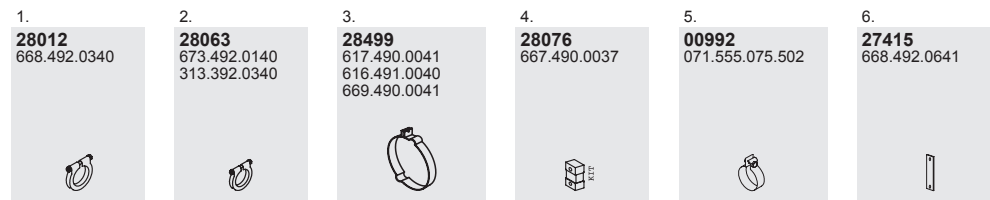

Horizontal
LHD
Standard

Series 809

Type Baumuster

Euro I 673.010
 673.011
 809 673.012
 673.013
 WB 3150, 3360,
 3700, 4250, 4900 673.014
 ►CHno5.152.276

Front pipe

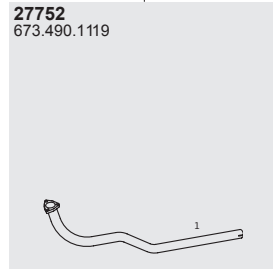

Silencer

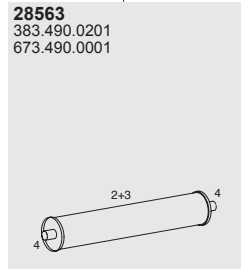

Tail pipe



Mounting Parts

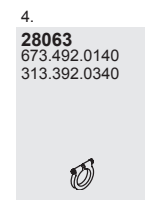
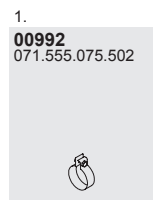

Horizontal
 LHD
 Standard







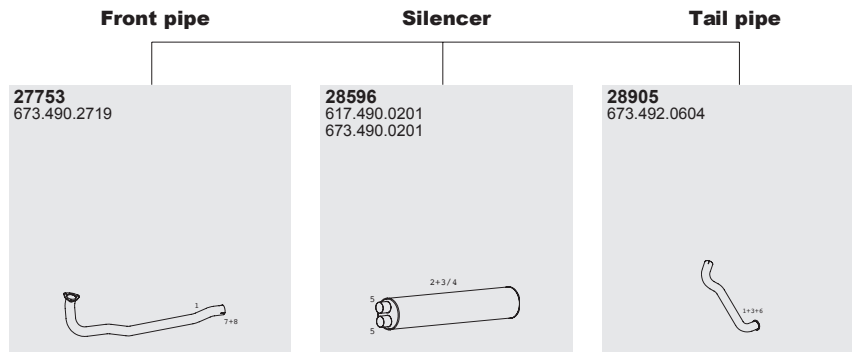

Series 809

Type Baumuster

Euro I 673.010
 673.011
 809 673.012
 673.013
 WB 3150, 3360,
 3700, 4250, 4900 673.014
 5.152.277 ▶CHno
 5.325.174



Mounting Parts

- | | | | | | | | |
|--|---|--|--|--|--|---|--|
| <p>1.
00992
071.555.075.502</p>  | <p>2.
28467
617.491.0440</p>  | <p>3. ▶CHno 5.194.472
28081
309.490.0037</p>  | <p>4. 5.194.473 ▶CHno
28480
381.492.0082
301.492.0382
0201.175.00</p>  | <p>5.
28063
673.492.0140
313.392.0340</p>  | <p>6.
28062
673.492.1041
309.492.1441</p>  | <p>7. CAT.retrofit
18573</p>  | <p>8. Kit
18893</p>  |
|--|---|--|--|--|--|---|--|

Horizontal
 LHD
 Standard

Series 809

Type Baumuster

Euro I 673.010
 673.011
 809 673.012
 673.013
 WB 3150, 3360,
 3700, 4250, 4900 673.014
 5.325.175 ▶CHno

Front pipe

26792
 673.490.3119



26793
 670.492.0401
 670.490.0065
 673.490.0065



Silencer

28596
 617.490.0201
 673.490.0201

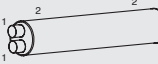

Tail pipe

26392
 673.492.2604

5.325.175 ▶CHno 5.743.552



26399
 673.492.4804
 673.492.4404

5.743.553 ▶CHno



Mounting Parts

1.
28063
 673.492.0140
 313.392.0340



2.
28422
 673.491.2241
 673.491.1141



3.
28078
 384.987.7140
 001.987.9640
 001.987.5340



4. ▶CHno 5.743.552
28062
 673.492.1041
 309.492.1441



5.
00992
 071.555.075.502



6. ▶CHno 5.743.552
28081
 309.490.0037



7.
00994
 071.555.078.502



Horizontal
 LHD
 Standard

Series 809 D

Type	Baumuster
Euro I	670.001
	670.002
809 D	670.003
	670.041
	670.042
	670.061
	670.062
	670.063

Front pipe

Silencer

Tail pipe

27758
668.490.0519

►CHno 018.997



27757
668.490.0819

►CHno 018.997



28563
383.490.0201
673.490.0001

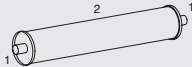

28932
668.492.2804



25615
668.490.2619

018.998 ►CHno



25638
668.490.2719

018.998 ►CHno



Mounting Parts

1.
00992
071.555.075.502



2.
28425
668.492.2140
668.490.0241



3.
28076
667.490.0037



4.
27415
668.492.0641



Horizontal
LHD
Standard

Series 809 DT

Type

Euro I
809 DT

Baumuster

670.199

Silencer

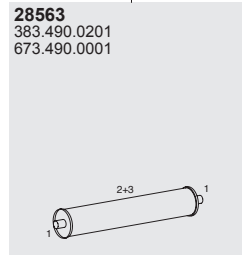

Mounting Parts

1.
00992
071.555.075.502



2.
28425
668.492.2140
668.490.0241



3.
28076
667.490.0037



Horizontal
LHD
Standard

Series 809 K

Type
Euro I
809 K
WB 3150
5.152.277 ▶CHno
5.325.174

Baumuster
673.042

Front pipe



Silencer

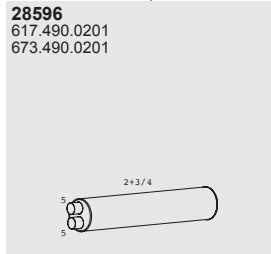

Tail pipe



Mounting Parts

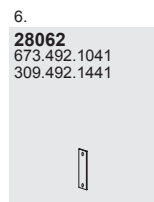
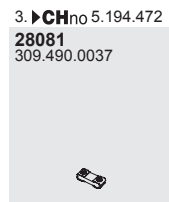
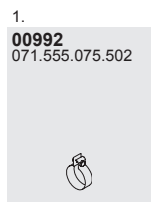

Horizontal
LHD
Standard

Series 809 K

Type **Baumuster**

Euro I 673.042

809 K

WB 3150

5.152.277 ▶CHno
5.325.174

Front pipe

Silencer

Tail pipe

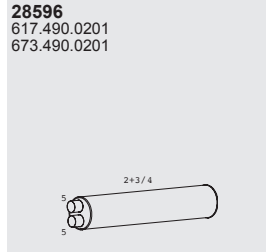
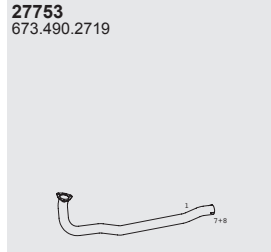

Mounting Parts

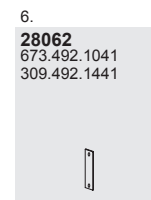
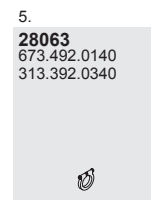

Horizontal
LHD
Standard

Series 809 K

Type
Euro I
809 K
WB 3150
5.325.175 ▶CHno

Baumuster
673.042

Front pipe

26792
673.490.3119



26793
670.492.0401
670.490.0065
673.490.0065



Silencer

28596
617.490.0201
673.490.0201

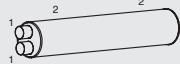

Tail pipe

26393
673.492.2704
5.325.175 ▶CHno 5.743.552



26399
673.492.4804
673.492.4404
5.743.553 ▶CHno



Mounting Parts

1.
28063
673.492.0140
313.392.0340



2.
28422
673.491.2241
673.491.1141



3.
28078
384.987.7140
001.987.9640
001.987.5340



4. ▶CHno 5.743.552
28062
673.492.1041
309.492.1441



5.
00992
071.555.075.502



6. ▶CHno 5.743.552
28081
309.490.0037



7.
00994
071.555.078.502



Horizontal
LHD
Standard

Series 811 D/DK

Type Baumuster

Euro I	670.302 670.303
811D WB 3700, 4250	670.362 670.363
811D K WB 3150, 3700	670.341 670.342

Front pipe

Silencer

Tail pipe

27755
669.490.1119

▶CHno 018919

27751
669.490.0619

▶CHno 018.919

28538
669.490.0101
617.490.0301

▶CHno 018.919

28932
668.492.2804

25624
669.490.2519

018920 ▶CHno

25636
669.490.3019

018.920 ▶CHno

28112
667.490.0001

018.920 ▶CHno

18574

CAT

Mounting Parts

1.
00992
071.555.075.502

1. Alternative.
28063
673.492.0140
313.392.0340

2.
28499
617.490.0041
616.491.0040
669.490.0041

3.
28076
667.490.0037

4.
27415
668.492.0641

5. CAT retrofit
18573

6. Kit
18833

Horizontal
LHD
Standard

Series 814 D

Type	Baumuster
Euro I	670.312
	670.313
814 D	670.364
	670.365
WB 3150, 3700, 4250	670.366

Front pipe

Silencer

Tail pipe

27755
669.490.1119

►CHno 018919

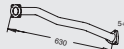

27751
669.490.0619

►CHno 018.919



28538
669.490.0101
617.490.0301

►CHno 018.919

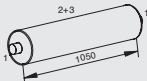

28932
668.492.2804



25624
669.490.2519

018920 ►CHno

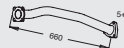

25636
669.490.3019

018.920 ►CHno



28112
667.490.0001

018.920 ►CHno

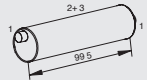

18574

CAT

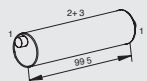

Mounting Parts

1.
00992
071.555.075.502



1. Alternative.
28063
673.492.0140
313.392.0340



2.
28499
617.490.0041
616.491.0040
669.490.0041



3.
28076
667.490.0037



4.
27415
668.492.0641



5. CAT retrofit
18573



6. Kit
18833



Horizontal
LHD
Standard

Series 817 F

Type	Baumuster
Euro I	676.080
817 F	676.081
►CHno5.337.342	676.082
WB 3150, 3700	

Front pipe

Silencer

Tail pipe

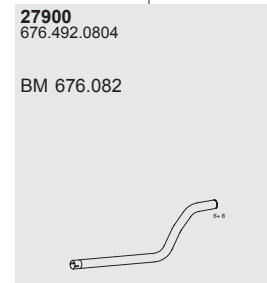
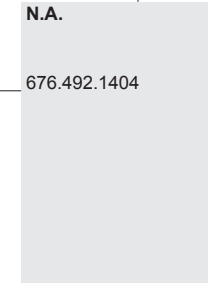
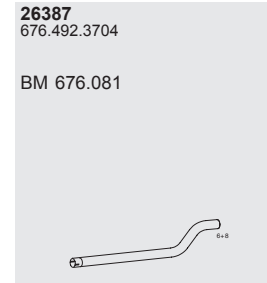
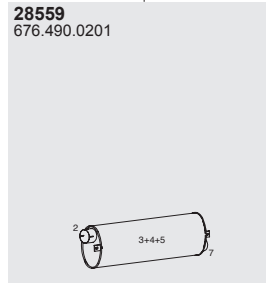

Mounting Parts

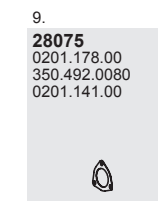
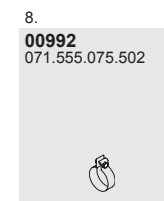
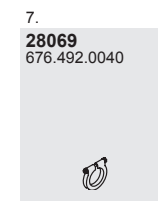
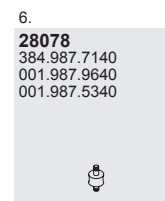
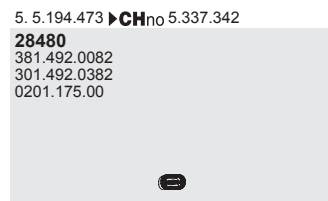
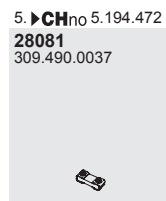
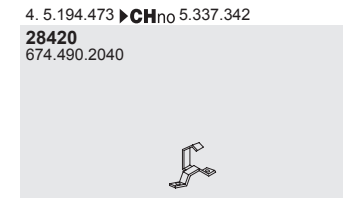
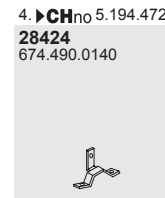
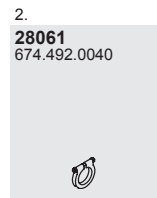
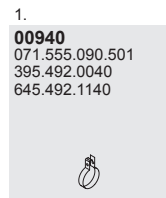

Horizontal
LHD
Standard

Series CITARO

Type

Euro III
01/1998 →



④X②
⑥X②

O 530

Citaro N3
Citaro GN3

☞ **OM 457.933**
☞ **OM 457.934**
☞ **OM 457.935**
☞ **OM 457.943**
12,0l tr.
6 cyl.
185 KW/252 HP
220 KW/299 HP
260 KW/354 HP

Baumuster

628.000
628.001
628.200
628.250
628.050

Front pipe

27762
834.100.0254
621.490.0065



25744
628.490.1219

Insulation
BM 628.250



Silencer

27556
628.490.0601

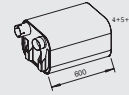

Tail pipe

21328
628.490.1321

AEMI nsulation
BM 628.250

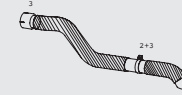

21313
628.490.0121

AEMI nsulation
BM 628.000.200
▶CHno 092959

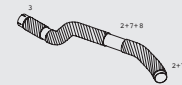

21322
628.490.0221

AEMI nsulation
BM 628.000,200

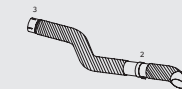

Mounting Parts

1.
28410
621.997.0090



2.
28089
322.504.0212



3.
00981
071.555.104.501
940.492.0240



4.
28084
300.492.0082



5.
28418
301.492.0015
301.491.0015
0201.136.00



6.
28417
301.491.0215



7.
27053
628.528.0440



8. x2
27018
628.995.0115



9.
00986
655.492.0140



Horizontal
LHD/RHD
Standard

Series CITARO

Type

Euro III
01/1998 →



O 530

Citaro
Citaro (Üstra
Hannover,
Germany)
Citaro G
Citaro GÜ/LÜ/
MÜ/Ü

457 hLA
12,0 ltr.
6 cyl.
182 KW/252 HP
220K W/299 HP
260 KW/354 HP

Baumuster

628.000
628.001
628.002
628.010
628.011
628.012
628.043
628.045
628.047
628.048
628.100
628.101
628.143
628.145
628.147
628.148
628.200
628.201
628.202
628.210
628.243
628.245
628.247
628.248

Front pipeT

25742
628.490.0065

Inox



25749
628.490.0165



Silencer

27557
628.490.0101
628.490.0401
628.490.0501
Inox
▶CHno 097920

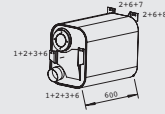

27551
628.490.0901

097921 ▶CHno
BM 628.043, 045, 047,
048, 143, 145, 147, 148,
243, 245, 247, 248

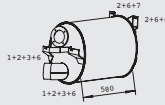

27555
628.490.1201

BM 628.043, 045, 047,
143, 145, 147, 148,
248, 245, 247, 248

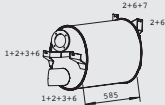

ail pipe

28275
628.492.0804

Ø 104,5



28271
628.490.1021

Ø1 24,5
Inox



21326
628.492.0304

Ø 104,5
Inox



28272
628.492.2404

Ø1 24,5
Inox



21325
628.492.0704

Ø 104,5
Inox
Excl.B M6 28.010,
011,012,210



21321
628.492.3104

Ø1 24,5
Inox



21327
628.492.0204

Ø 104,5
Inox
Euro II



Mounting Parts

1.

27057
628.491.0041



2.

28084
300.492.0082



3.

27058
628.491.0030



4.

00981
071.555.104.501
940.492.0240



5.

00969
071.555.124.501
655.492.01401



6.

27056
628.491.0415



7.

28418
301.492.0015
301.491.0015
0201.136.00



8.

27479
620.492.6241
396.492.3241



Horizontal
LHD/RHD
Standard

Series CITARO

Type

Euro III
01/1998 →



④X②
⑥X②

O 530

Citaro N3
Citaro GN3

🔧 OM 906.921
🔧 OM 906.961
🔧 OM 906.962
6,4l tr.
6 cyl.
180 KW/245 HP
205 KW/279H P

Baumuster

628.000
628.050
628.200
628.250

Front pipe

25741
628.490.0325

AEM Insulation

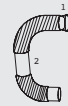

25693
973.490.0165



N.A.

628.490.0919
BM 628.050,250
BM 628.000:
097153 ▶CHno

25743
628.490.1019

AEM Insulation
BM 628.050, 250
BM 628.000,200:
097153 ▶CHno

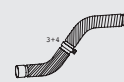

Silencer

27556
628.490.0601

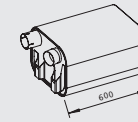

Tail pipe

21322
628.490.0221

AEMI nsulation

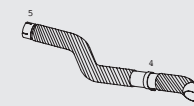

21313
628.490.0121

AEMI nsulation
BM 628.050,250

BM 628.000,200:
▶CHno 092959

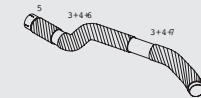

Mounting Parts

1.
28426
620.997.0590



2.
27062
628.490.0041



3.
27053
628.528.0440



4.
28089
322.504.0212



5.
00981
071.555.104.501
940.492.0240



6. x2
27018
628.995.0115



7.
00986
655.492.0140



Horizontal
LHD/RHD
Standard

Series CITARO

Type

Euro III
01/98 →



④X②
⑥X②

O 530

Citaro N3
Citaro NUE3
Citaro N3 LANG
Citaro GN3
Citaro GNUE3

906 hLA
6,4l tr.
6 cyl.
180 KW/245 HP

Baumuster

628.000
628.001
628.002
628.043
628.045
628.047
628.048
628.100
628.101
628.143
628.145
628.147
628.148
628.200
628.201
628.202
628.243
628.245
628.247
628.248
628.447

Front pipe

25745
628.490.0019

Insulation
Excl.B M6 28.040, 240



25693
973.490.0165



Silencer

27558
628.490.0301

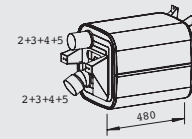

27515
628.490.0701

RHD

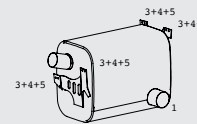

28276
628.492.0104

Euro II
BM 628.000.001,002,
BM 628.100,101,
BM 628.200,201,202



28273
628.492.1504

Insulation I
BM 628.000,040,043,
200,240,243



Tail pipe

28275
628.492.0804

BM 628.043,045,047,048
BM 628.143,145,148,
BM 628.243,245,247,248,
BM 628.447



21333
628.492.1604

Insulation
BM 628.000, 200

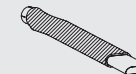

28277
628.492.0004



Mounting Parts

1.
00981
071.555.104.501
940.492.0240



2.
27452
619.492.0241
617.492.0141



3.
28084
300.492.0082



4.
28412
301.491.0215



5.
27058
628.491.0030



Horizontal
LHD/RHD
Standard

Series CITARO

Type

Euro III
01/1998 →

O 530

Low Entry
12/13 m **OM 457.941**
12,0l tr.
6 cyl.
185 KW/252 HP **OM 457.952**
 OM 457.964
 OM 457.965
12,0l tr.
6 cyl.
220 KW/299 HP

Baumuster

628.583
628.584
628.587
628.687

Front pipe

21670
629.490.2010
629.490.0910

AEM insulation

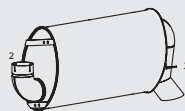

Silencer

27516
629.490.0301
629.490.0101

Mounting Parts

1.
27401
942.997.0290
000.995.86022.
00961
071.555.124.500
000.492.1240
000.492.00403.
30481
000.491.0285Horizontal
LHD/RHD
Standard

Series CITARO

Type

Euro III
01/98 →



④XE
⑥XE

O 530

Citaro N3
Citaro NUE3
Citaro N3 LANG
Citaro GN3
Citaro GNUE3
Citaro NUE3

☞ **OM 906 HLA**
6,4l tr.
6 cyl.
180 KW/245 HP
205 KW/279 HP

☞ **OM 457 HLA**
12,0 ltr.
6 cyl.
185 KW/252 HP
220K W/299 HP
260 KW/354 HP

Baumuster

628.043
628.045
628.047
628.048
628.143
628.144
628.148
628.243
628.245
628.247
628.248
628.447

Front pipe

25742
628.490.0065

25749
628.490.0165

Silencer

27539
628.490.3214
628.490.2314

DPF
Complete unit
Replaceable parts:3,4,5,6,7,8

27508
000.491.0006

Tail pipe

28271
628.490.1021

AEM
097921 ▶CHno

27308
628.490.0027

AEM
Excl.B M6 28.447

27392
628.490.0127

AEM

Mounting Parts

1.
00968
071.555.120.500
071.555.120.502

2.
00961
071.555.124.500
000.492.1240
000.492.0040

3. Inlet
27020
000.490.0009

4. CAT
27888
000.490.6714

5. DPF
27877
000.490.2392
000.490.0992

6. Outlet
27033
000.490.0809

7. Gasket for Pos.
3+4+5+6
10018
000.491.0880

8. V-clamp for Pos.
3+4+5+6
94462
000.995.2602

Horizontal
LHD/RHD
Standard

Series CITARO

Type

Euro III
01/98 →



④X②
⑥X②

O 530

Citaro N3
Citaro GN3

☞ **OM 906 HLA**
6,4l tr.
6 cyl.
180 KW/245 HP
205 KW/279H P

☞ **OM 457 HLA**
12,0l tr.
6 cyl.
185 KW/252 HP
220 KW/299 HP
260 KW/354 HP

Baumuster

628.040
628.043
628.240
628.243

Front pipe

Silencer

Tail pipe

25742
628.490.0065



27534
628.490.2514

DPF
Complete unit
Replaceable parts:
8,9,10,11,13,14
▶CHno 110371

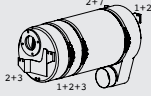

27593
000.490.0016



21345
628.492.2204

Insulation



21343
628.490.1221

AEMI nsulation



25749
628.490.0165



27530
628.490.3414

DPF
Complete unit
Replaceable parts:
8,9,10,12,13,14
110372 ▶CHno

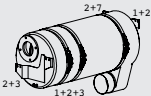

21342
628.490.0527

Insulation



Mounting Parts

1.
27479
620.492.6241
396.492.3241



2.
28084
300.492.0082



3.
28417
301.491.0215



4.
28089
322.504.0212



5.
00981
071.555.104.501
940.492.0240



6.
00968
071.555.120.500
071.555.120.502



7.
28418
301.492.0015
301.491.0015
0201.136.00



8. Inlet
27020
000.490.0009



9. CAT
27888
000.490.6714



10. DPF
27877
000.490.2392
000.490.0992



11. Outlet
27010
000.490.0509



12. Outlet
27030
000.490.1109



13. Gasket for Pos.
8+9+10+11,
8+9+10+12

10018
000.491.0880



14. V-clamp for Pos.
8+9+10+10,
8+9+10+12

94462
000.995.2602



14. V-clamp for Pos.
8+9+10+11,
8+9+10+12

94462
000.995.2602



Horizontal
LHD/RHD
Standard

Series CITARO

Type

Euro IV
01/04 →



④X②
⑥X②

O 530

Citaro G
Citaro LUE
Citaro GUE
Citaro K
Citaro MUE

🔧 **OM 906 HLA**
6,4l tr.
6 cyl.
170 KW/231 HP
180 KW/245 HP
205 KW/279 HP

🔧 **OM 457 HLA**
12,0 ltr.
6 cyl.
185 KW/252 HP
220K W/299 HP
260 KW/354 HP
300 KW/408 HP

Baumuster

628.080
628.083
628.085
628.087
628.187
628.280
628.283
628.285
628.287
628.483
628.487

Front pipe

23770
628.490.2919

OM 906 HLA

23774
628.490.2019

OM 457 HLA

Silencer

27597
001.490.2714
001.490.7914

DPF
Complete unit
Replaceable parts:3,4,5,6

Tail pipe

27393
628.490.1727

27394
628.490.2027

27391
628.490.1827
628.490.2627

Insulation

Mounting Parts

1.
28410
621.997.0090

2.
00961
071.555.124.500
000.492.1240
000.492.0040

3. DPF
27876
000.490.2792

4. Gasket
27026
000.490.0380

5. Gasket
27027
000.490.0180

6. Cover
27025
000.491.0303

Horizontal
LHD/RHD
Standard

Series CITARO

Type

Euro IV
01/04 →



O 530

Citaro Low Entry
Citaro Low Entry
UE

OM 457 HLA
12,0l tr.
6 cyl.
185 KW/252 HP
220 KW/299 HP
260 KW/354 HP
300 KW/408 HP

Baumuster

632.036
632.038

Front pipeT

Silencer

ail pipe

21648
633.490.1210
633.490.1310
633.490.1810



27596
001.490.2814

SCR



21330
633.490.0327

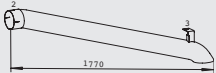

21667
633.490.1010
633.490.1610

Insulation



27595
001.490.4914

SCR
With NOx sensor

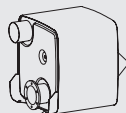

21347
633.490.0527

Inox
With NOx sensor

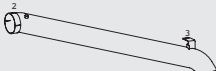

Mounting Parts

1.
27401
942.997.0290
000.995.8602



2.
00961
071.555.124.500
000.492.1240
000.492.0040



3.
30481
000.491.0285



Horizontal
LHD/RHD
Standard

Series CITARO

Type

Euro IV
01/04 →



④X②

⑥X②

O 530

Citaro
Citaro LUE
Citaro G
Citaro GUE
Citaro K
Citaro MUE

✎ OM 457 HLA
12,0l tr.
6 cyl.
185 KW/252 HP
220 KW/299 HP
260 KW/354 HP
300 KW/408 HP

Baumuster

628.080
628.083
628.085
628.087
628.187
628.280
628.283
628.285
628.287
628.483
628.487

Front pipe

23749
628.490.4119



23743
628.490.3319
628.490.1919

RHD
BM 628.080, 083



Silencer

27594
000.490.7714

SCR



27599
001.490.4814

SCR
Excl.B M 628.483



Tail pipe

27397
628.490.1527

Insulation
RHD
BM 628.080,083,280,283



28271
628.490.1021

AEM



21321
628.492.3104



Mounting Parts

1.
28410
621.997.0090



2.
00961
071.555.124.500
000.492.1240
000.492.0040



Horizontal
LHD/RHD
Standard

Series CONECTO

Type

Euro II



④X②
⑥X②

O 345

🔧 **OM 489.960**
🔧 **OM 489.961**
10,0l tr.
5 cyl.
155 KW/210 HP
184 KW/250 HP

🔧 **OM 447.947**
🔧 **OM 447.948**
🔧 **OM 447.949**
🔧 **OM 447.960**
12,0l tr.
6 cyl.
157 KW/213 HP
184 KW/250 HP
220 KW/300 HP

Baumuster

671.000
671.005
671.010
671.312
671.322
671.327

Front pipe

27762
834.100.0254
621.490.0065

23667
671.490.1119
671.490.0219

Insulation

Silencer

21589
671.490.0001

Tail pipe

21348
357.490.3021

AEMI nsulation

Mounting Parts

1.
28410
621.997.0090

2.
00587
357.492.1240

3.
28418
301.492.0015
301.491.0015
0201.136.00

4.
28084
300.492.0082

5.
28417
301.491.0215

6.
00971
071.555.114.500

Horizontal
LHD/RHD
Standard

Series CONECTO

Type

Euro III
11/2001 →



O 345

OM 906.960
6,4l tr.
6 cyl.
205 KW/279 HP

Baumuster

671.015
671.020
671.030
671.042

Front pipe

25745
628.490.0019

Insulation



25693
973.490.0165



Silencer

27558
628.490.0301

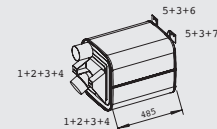

Tail pipe

21325
628.492.0704



28275
628.492.0804



28271
628.490.1021

AEM



Mounting Parts

1.
27452
619.492.0241
617.492.0141



2.
28084
300.492.0082



3.
28417
301.491.0215



4.
27058
628.491.0030



5.
27056
628.491.0415



6.
28418
301.492.0015
301.491.0015
0201.136.00



7.
27479
620.492.6241
396.492.3241



8.
00981
071.555.104.501
940.492.0240



Horizontal
LHD/RHD
Standard

Series CONECTO

Type

Euro III
11/2001 →



O 345

OM 457.942
12,0l tr.
6 cyl.
185 KW/252 HP

OM 906.960
6,4l tr.
6 cyl.
205 KW/279 HP

Baumuster

671.015
671.020
671.030
671.042
671.332

Front pipe

25742
628.490.0065



25749
628.490.0165

Excl.B M 671.332



Silencer

27555
628.490.1201

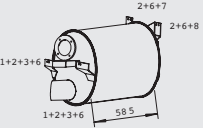

Tail pipe

28271
628.490.1021

AEM



28275
628.492.0804



Mounting Parts

1.
00969
071.555.124.501
655.492.01401



2.
27057
628.491.0041



3.
27479
620.492.6241
396.492.3241



4.
28084
300.492.0082



5.
28417
301.491.0215



6.
27058
628.491.0030



7.
27056
628.491.0415



8.
28418
301.492.0015
301.491.0015
0201.136.00



Horizontal
LHD/RHD
Standard

Series INTEGRO

Type

Euro IV
01/06 →



④X②
⑥X②

O 550

Integro
IntegroM
IntegroL

OM 457 HLA
12,0l tr.
6 cyl.
220 KW/299 HP
260 KW/354 HP
300 KW/408 HP

Baumuster

633.001
633.002
633.004

Front pipe

23772
633.490.1410



Silencer

27597
001.490.2714
001.490.7914

DPF
Complete unit
Replaceable parts:4,5,6,7

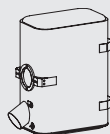

Tail pipe

27390
633.490.1510

AEM Inox

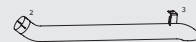

Mounting Parts

1.
27401
942.997.0290
000.995.8602



2.
00961
071.555.124.500
000.492.1240
000.492.0040



3.
30481
000.491.0285



4. DPF
27876
000.490.2792



5. Gasket
27026
000.490.0380



6. Gasket
27027
000.490.0180



7. Cover
27025
000.491.0303



Horizontal
LHD/RHD
Standard

Series INTEGRO

Type

Euro IV
01/06 →



④X②
⑥X②

O 550

Integro
IntegroM
IntegroL

OM 457 HLA
12,0l tr.
6 cyl.
185 KW/252 HP
220 KW/299 HP
260 KW/354 HP
300 KW/408 HP

Baumuster

633.001
633.002
633.004

Front pipeT

Silencer

ail pipe

21648
633.490.1210
633.490.1310
633.490.1810
OM 457 HLA



27596
001.490.2814

SCR

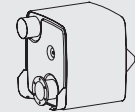

21330
633.490.0327

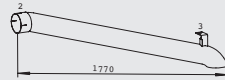

21398
633.490.0427

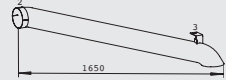

21667
633.490.1010
633.490.1610

Insulation



27595
001.490.4914

With NOx sensor
SCR



21347
633.490.0527

Inox
OM 457 HLA
With NOx sensor

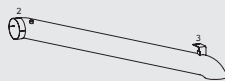

Mounting Parts

1.
27401
942.997.0290
000.995.8602



2.
00961
071.555.124.500
000.492.1240
000.492.0040



3.
30481
000.491.0285



Horizontal
LHD/RHD
Standard

Series INTOURO

Type

Euro IV



O 560

Intouro
IntouroE
IntouroM
IntouroM E

OM 926 LA
7,2l tr.
6 cyl.
210 KW/286 HP

Baumuster

633.051

633.052

633.251

633.252

Front pipe

23768
633.492.0201
633.490.1710



23683
633.492.0204



Silencer

27591
000.490.6614
002.490.5114

SCR

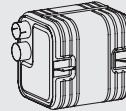

27347
633.492.0433

AEM Insulation



Tail pipe

27348
633.490.0227

AEM Insulation

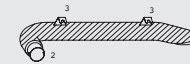

Mounting Parts

1.
28426
620.997.0590



2.
00988
071.555.100.501
940.492.0340



3.
30481
000.491.0285



Horizontal
LHD/RHD
Standard

Series O 301

Type

O 301
Reiseomnibus
WB 4000

►CHno950.099
Incl.
950.122-950.125,
950.142

Baumuster

697.001

Front pipe

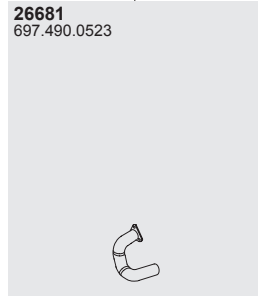

Silencer

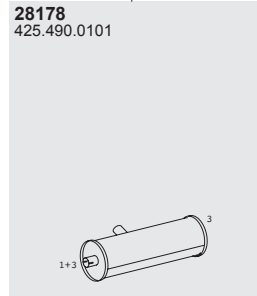

Tail pipe

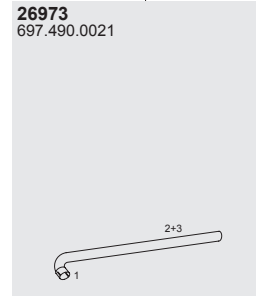

Mounting Parts

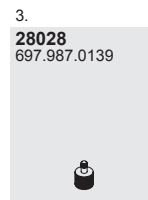
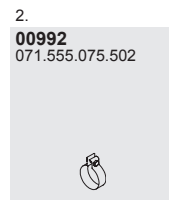
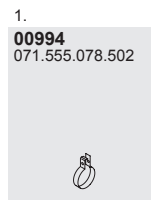

Horizontal
LHD
Standard

Series O 301

Type
 O 301
 Reiseomnibus
 WB 4000
 ►CHno950.148

Baumuster
 697.006

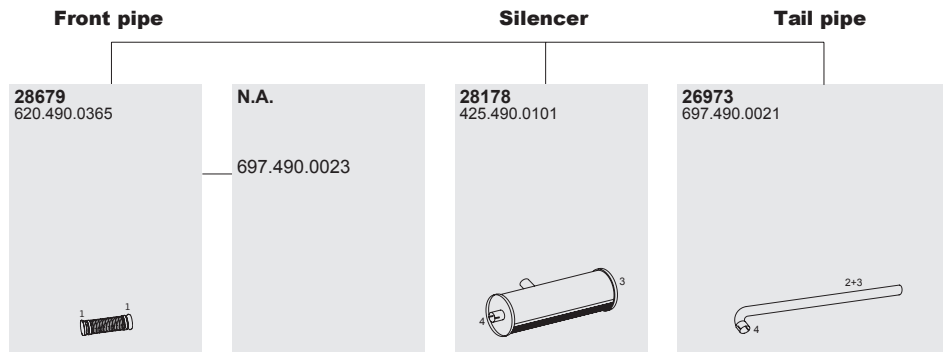

Mounting Parts

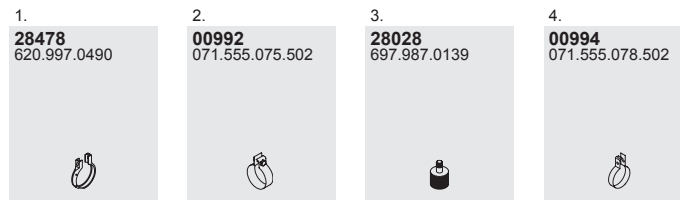

Horizontal
 LHD
 Standard

Series O 301

Type
 O 301
 Reiseomnibus
 WB 4000
 ▶CHno950.148

Baumuster
 697.006

Front pipe

28679
 620.490.0365



N.A.
 697.490.0023

Silencer

28178
 425.490.0101



Tail pipe

26973
 697.490.0021

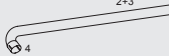

Mounting Parts

1.
28478
 620.997.0490



2.
00992
 071.555.075.502



3.
28028
 697.987.0139



4.
00994
 071.555.078.502



Horizontal
 LHD
 Standard

Series O 301

Type

O 301
Reiseomnibus
WB 4000
950.149 ▶CHno

Baumuster

697.006

Front pipeT

28699
620.490.0465



N.A.

697.490.0123

Silencer

28179
697.490.0401

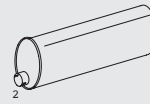

ail pipe

26974
697.490.0121



Mounting Parts

1.
28426
620.997.0590



2.
00940
071.555.090.501
395.492.0040
645.492.1140



3.
28081
309.490.0037



Horizontal
LHD
Standard

Series O 302

Type

O 302
WB 4685, 5050,
5850, 6055

Baumuster

302.214 302.242
302.220 302.246
302.224 302.252
302.230 302.256
302.234 302.262
302.240 302.266
302.244 302.272
302.250 302.276
302.254 302.282
302.264 302.286
302.268 302.292
302.269 302.296
302.270 302.299
302.274 302.213
302.280 302.233
302.284 302.243
302.290 302.283
302.294 302.293
302.201
302.203
302.206
302.208
302.211
302.215
302.221
302.225
302.231
302.235
302.241
302.245
302.251
302.255
302.261
302.265
302.271
302.202
302.207
302.212
302.216
302.222
302.226
302.232
302.236

Front pipe

28721
302.490.0520

BM 302.201, 203, 206, 208, 211, 220, 221, 224, 225, 230, 231, 240, 241, 243, 244, 250, 251, 254, 255, 261, 264, 268-271, 275, 280, 281, 284, 290, 291, 294.



28722
302.490.1120

BM 302.215, 235, 245, 265, 285, 295, - 649.194
BM 302.202, 207, 212, 213, 216, 222, 226, 232, 233, 236, 242, 243, 246, 256, 262, 266, 272, 276, 282, 283, 286, 292, 293, 296, 298, 299.



Silencer

N A.

302.490.2101

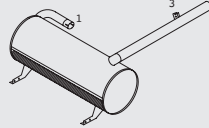

28786
302.492.0601



Mounting Parts

1.
00998
071.555.070.501



2.
28085
302.490.0080
442.492.0080



3.
28450
305.492.0182
000.492.0082
357.492.0182



4.
28072
312.492.1080
442.492.0280



Horizontal
LHD
Standard

Series O 303

Type

O 303
 WB 4150, 4156,
 4521, 5083,
 6330
 ►CHno039.438
 Built by
 Mercedes
 ►CHno040.793
 Not built by
 Mercedes

Baumuster

301.105
 301.115
 301.125
 301.135
 301.165
 600.109
 600.110
 600.111
 600.131
 600.150
 600.151
 600.159
 600.160
 600.161
 600.190

Front pipe

28724
301.490.0419



28738
301.490.0068



28720
301.490.0519



28738
301.490.0068



Silencer

28571
301.490.0601

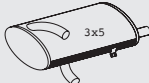

Tail pipe

28353
301.490.1221



Mounting Parts

1.
00998
071.555.070.501



2.
00995
071.555.073.500



3.
28480
381.492.0082
301.492.0382
0201.175.00



4.
28085
302.490.0080
442.492.0080



5.
28007



Horizontal
 LHD
 Standard

Series O 303

Type

O 303

WB 4150, 4156,
4521, 5083,
5381,
5623, 6330

Built by
Mercedes
039.439 ▶CHno

Not built by
Mercedes
040.794 ▶CHno

BM 600.134, 153
▶CHno 058.616

Baumuster

301.105
301.115
301.125
301.135
301.165
600.109
600.110
600.111
600.131
600.134
600.150
600.151
600.153
600.159
600.160
600.161
600.190

Front pipe

28736
301.490.3019



28735
301.492.0059



28737
301.490.2819



28735
301.492.0059



Mounting Parts

1.
00992
071.555.075.502



2.
00995
071.555.073.500



3.
28480
381.492.0082
301.492.0382
0201.175.00



4.
28085
302.490.0080
442.492.0080



5.
28007



Silencer

28562
301.490.2301

▶CHno 058.616

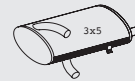

28105
600.490.0201

058.617 ▶CHno

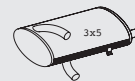

Tail pipe

28353
301.490.1221

▶CHno 058.616
BM 600.134
BM 600.153



28352
300.490.0821
301.490.0821

▶CHno 058.616



28923
600.492.0004

058.617 ▶CHno
AIIB MN o'sE except BM 600.134
BM 600.153



28354
301.492.0104

058.617 ▶CHno
BM 600.134
BM 600.153



Horizontal
LHD
Standard

Series O 303

Type Baumuster

O 303	300.109
	300.110
WB 4150, 4521,	300.111
5083, 5381,	300.112
5623, 6330	300.114
	300.115
Built by	300.121
Mercedes	300.123
►CHno033093	300.125
	300.130
Not built by	300.133
Mercedes	300.139
►CHno033342	300.140
	300.141
Includes	300.142
chassisN o's	300.143
033380, 033388,	300.144
033409, 033437,	300.145
033460, 033485,	300.159
033510, 033534,	300.160
033535, 033546,	300.161
033558, 033559,	300.162
033570, 033588,	300.163
033589, 033610,	300.164
033620, 033621,	300.165
033641, 033649,	300.166
033650, 033669,	300.167
033678, 033679	300.170

Front pipe

28724
301.490.0419



28738
301.490.0068



28720
301.490.0519



28738
301.490.0068



Silencer

28571
301.490.0601



Tail pipe

28352
300.490.0821
301.490.0821

BM 300.109, 110, 111, 121, 130,
139, 140, 141, 159, 160, 161, 170



28353
301.490.1221

BM 300.112, 114, 115, 123, 124,
125, 133, 142, 143, 144, 145, 162,
163, 164



Mounting Parts

1.
00995
071.555.073.500



2.
28480
381.492.0082
301.492.0382
0201.175.00



3.
28085
302.490.0080
442.492.0080



4.
00998
071.555.070.501



5.
28007



Horizontal
LHD
Standard

Series O 303

Type Baumuster

O 303	300.114
	300.115
WB 4150, 4521,	300.109
5083, 5381,	300.110
5623, 6330	300.111
Built by	300.112
Mercedes	300.121
033094 ▶CHno	300.123
	300.125
Not built by	300.130
Mercedes	300.133
033343 ▶CHno	300.139
	300.140
Includes	300.141
ChassisN o's	300.142
033380, 033388,	300.143
033409, 033437,	300.144
033460, 033485,	300.145
033510, 033534,	300.154
033535, 033546,	300.159
033558, 033559,	300.160
033570, 033588,	300.161
033589, 033610,	300.162
033620, 033621,	300.164
033641, 033649,	300.165
033650, 033669,	300.170
033678, 033679	300.190
	300.510
	300.511
	300.519
	300.520
	300.521
	300.529
	300.530
	300.531

Horizontal
LHD
Standard

Front pipe

28736
301.490.3019



28735
301.492.0059



28737
301.490.2819



28735
301.492.0059



Silencer

28762
301.490.2301



Tail pipe

28352
300.490.0821
301.490.0821

BM 300.109, 110, 111, 121, 130, 139, 140,
141, 159, 160, 161, 170, 190, 510, 511, 519,
520, 521, 529, 530, 531
BM 600.109, 110, 111, 131, 150, 151, 159,
160, 161, 190



28353
301.490.1221

BM 300.112, 114, 115, 123, 124, 125, 133,
142, 143, 144, 145, 162, 163, 164
BM 301.103, 104, 105, 106, 113, 114, 115,
116, 123, 124, 125, 126, 133, 134, 135, 136,
163, 164, 165, 166



Mounting Parts

1.
00995
071.555.073.500



2.
28480
381.492.0082
301.492.0382
0201.175.00



3.
28085
302.490.0080
442.492.0080



4.
28007



Series O 303

Type

O303

WB 4521

Baumuster

300.210
300.290
600.210
600.290
600.313
600.314
600.316

Front pipeT

27788
300.492.0159



Silencer

28533
300.490.0101

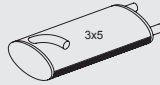

ail pipe

28933
300.492.0104



28939
300.490.0021



Mounting Parts

1.
00981
071.555.104.501
940.492.0240



2.
00942
674.490.2819
303.493.0643
071.555.085.502



3.
28480
381.492.0082
301.492.0382
0201.175.00



4.
28078
384.987.7140
001.987.9640
001.987.5340



5.
28007



Horizontal
LHD
Standard

Series O 303

Type Baumuster

O 303 301.102
 301.106
 WB 5083, 6330 301.112
 301.116
 301.122
 301.126
 301.132
 301.136
 301.162
 301.166
 301.305
 301.315
 301.325
 301.335
 301.365
 301.375

Front pipe

Silencer

Tail pipe

28724
301.490.0419

▶CHno 039438



28738
301.490.0068

▶CHno 039438



28571
301.490.0601

▶CHno 039438



28352
300.490.0821
301.490.0821

BM 301.102, 112,
122, 132, 162



28720
301.490.0519

▶CHno 039438



28738
301.490.0068

▶CHno 039438



28562
301.490.2301

039439 ▶CHno

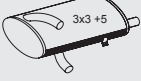

28353
301.490.1221

BM 301.106, 116,
126, 136, 166



28736
301.490.3019

039439 ▶CHno



28735
301.492.0059

039439 ▶CHno



28562
301.490.2301

039439 ▶CHno



28737
301.490.2819

039439 ▶CHno



28735
301.492.0059

039439 ▶CHno



Mounting Parts

1.
00998
071.555.070.501



2.
00995
071.555.073.500



3.
28480
381.492.0082
301.492.0382
0201.175.00



4.
28085
302.490.0080
442.492.0080



5.
28007



Horizontal
LHD
Standard

Series O 303

Type

O303

WB 5083

Baumuster

301.206

301.216

301.226

301.236

301.266

Front pipe

28724
301.490.0419



28738
301.490.0068



28720
301.490.0519



28738
301.490.0068



Silencer

28575
301.490.0501

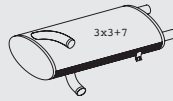

Tail pipe

28354
301.492.0104



28354
301.492.0104



Mounting Parts

1.
00998
071.555.070.501



2.
00995
071.555.073.500



3.
28480
381.492.0082
301.492.0382
0201.175.00



4.
28085
302.490.0080
442.492.0080



5.
28078
384.987.7140
001.987.9640
001.987.5340



6.
28486
301.492.0040



7.
28007



Horizontal
LHD
Standard

Series O 303

Type

O 303
 WB 5083, 5381, 5623, 6330
 Built by Mercedes
 ▶CHno033.093
 Not built by Mercedes
 033.342 ▶CHno
 Includes ChassisN o's
 033380, 033388
 033409, 033437
 033460, 033485
 033510, 033534
 033535, 033546
 033558, 033559
 033570, 033588
 033589, 033610
 033620, 033621
 033641, 033649
 033650, 033669
 033678, 033679

Baumuster

300.305
 300.312
 300.313
 300.314
 300.315
 300.323
 300.324
 300.325
 300.334
 300.335
 300.342
 300.343
 300.344
 300.345
 300.362
 300.363
 300.364
 300.365
 300.373
 300.374
 300.375
 300.384
 300.385
 300.393
 300.394
 300.395
 300.513
 300.514
 300.515
 300.523
 300.524
 300.525
 300.533
 300.534
 300.535

Front pipe

28724
301.490.0419



28738
301.490.0068



28720
301.490.0519



28738
301.490.0068



Silencer

28575
301.490.0501

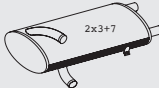

Tail pipe

28350
301.492.0004

BM 301.305 to BM 301.375



28354
301.492.0104

BM 300.305 to BM 300.535
 BM 301.203 to BM 301.275



28350
301.492.0004

BM 301.305 to BM 301.375



28354
301.492.0104

BM 300.305 to BM 300.535
 BM 301.203 to BM 301.275



Mounting Parts

1.
00995
071.555.073.500



2.
28480
381.492.0082
301.492.0382
0201.175.00



3.
28078
384.987.7140
001.987.9640
001.987.5340



4.
28085
302.490.0080
442.492.0080



5.
28486
301.492.0040



6.
00998
071.555.070.501



7.
28007



Horizontal
 LHD
 Standard

Series O 303

Type

O303
WB 5381, 5623

Baumuster

301.103
301.113
301.123
301.133
301.163
301.104
301.114
301.124
301.134
301.164

Front pipe

28724
301.490.0419



28738
301.490.0068



28720
301.490.0519



28738
301.490.0068



Silencer

28571
301.490.0601

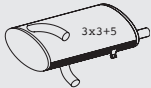

Tail pipe

283353
301.490.1221



Mounting Parts

1.
00998
071.555.070.501



2.
00995
071.555.073.500



3.
28480
381.492.0082
301.492.0382
0201.175.00



4.
28085
302.490.0080
442.492.0080



5.
28007



Horizontal
LHD
Standard

Series O 303

Type Baumuster

O 303 301.203
 301.213
 WB 5083, 5381 301.223
 301.233
 301.263
 301.273

Front pipe

28724
301.490.0419



28738
301.490.0068



28720
301.490.0519



28738
301.490.0068



Silencer

28575
301.490.0501

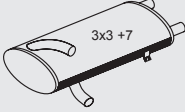

Tail pipe

28354
301.492.0104



28354
301.492.0104



Mounting Parts

1.
00998
071.555.070.501



2.
00995
071.555.073.500



3.
28480
381.492.0082
301.492.0382
0201.175.00



4.
28085
302.490.0080
442.492.0080



5.
28078
384.987.7140
001.987.9640
001.987.5340



6.
28486
301.492.0040



7.
28007



Horizontal
 LHD
 Standard

Series O 303

Type

O 303

WB 5381, 5623, 6330

►CHno058276

Built by Mercedes 033094 ►CHno
Not built by Mercedes 033343 ►CHno

Includes ChassisN o's

033380, 033388
033409, 033437
033460, 033485
033510, 033534
033535, 033546
033558, 033559
033570, 033588
033589, 033610
033620, 033621
033641, 033649
033650, 033669
033678, 033679
057848
058050, 057058
058150
058199 - 058205
058207 - 058212
058214 - 058225
058227 - 058229
058231 - 058236
058238 - 058241
058243 - 058251
058253
058255 - 058276

Baumuster

600.313
600.314
600.315
600.325
600.335
600.353
600.354
600.355
600.363
600.364
600.365
600.375
600.384
600.385
600.393
600.394
600.395

Front pipe

28736
301.490.3019



28735
301.492.0059



28737
301.490.2819



28735
301.492.0059



Silencer

28561
301.490.1901

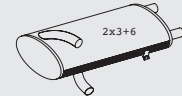

Tail pipe

28354
301.492.0104



28354
301.492.0104



Mounting Parts

1.
00995
071.555.073.500



2.
28480
381.492.0082
301.492.0382
0201.175.00



3.
28078
384.987.7140
001.987.9640
001.987.5340



4.
28085
302.490.0080
442.492.0080



5.
28486
301.492.0040



6.
28007



Horizontal
LHD
Standard

Series O 303

Type

O303
WB 5381, 5623,
6330
058277 ▶CHno

Baumuster

600.313
600.314
600.315
600.325
600.335
600.353
600.354
600.355
600.363
600.364
600.365
600.375
600.384
600.385
600.393
600.394
600.395

Front pipe

28736
301.490.3019



27721
300.490.0059
0201.166.00
300.492.0059



21721
600.490.0219



27721
300.490.0059
0201.166.00
300.492.0059



Silencer

28140
600.490.0001

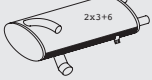

Tail pipe

28354
301.492.0104



28354
301.492.0104



Mounting Parts

1.
00995
071.555.073.500



2.
28480
381.492.0082
301.492.0382
0201.175.00



3.
28078
384.987.7140
001.987.9640
001.987.5340



4.
28085
302.490.0080
442.492.0080



5.
28486
301.492.0040



6.
28007





Horizontal
LHD
Standard

Series O 303

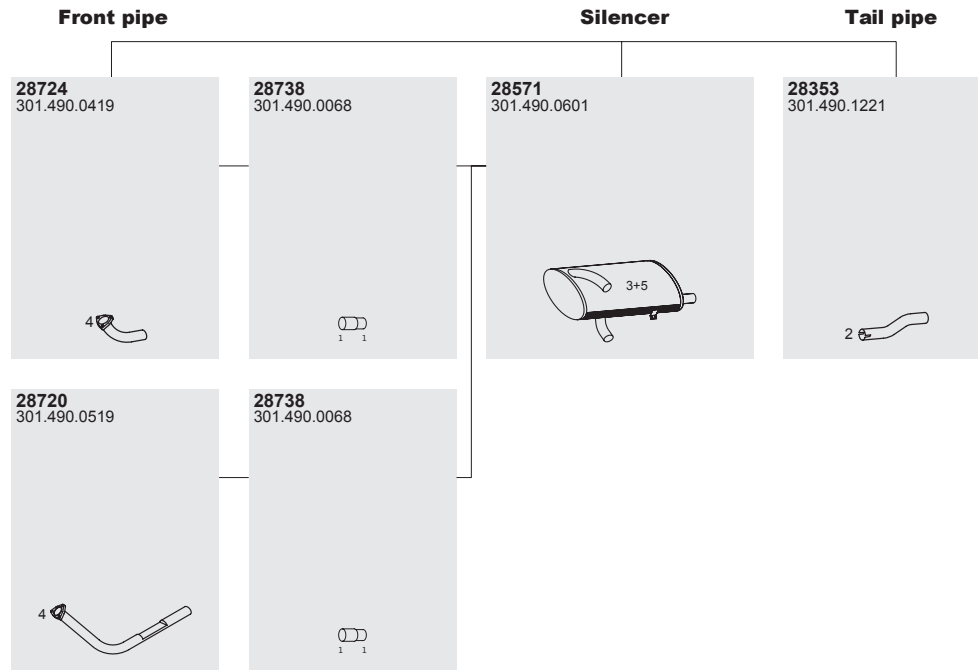
Type	Baumuster
O303	301.104 301.114
WB 5623	301.124 301.134 301.164



Mounting Parts

1. 00998 071.555.070.501	2. 00995 071.555.073.500	3. 28480 381.492.0082 301.492.0382 0201.175.00	4. 28085 302.490.0080 442.492.0080	5. 28007
				

Horizontal
LHD
Standard

Series O 303

Type

O303
WB 5623

Baumuster

301.304
301.314
301.324
301.334
301.364
301.374

Front pipe

28724
301.490.0419



28738
301.490.0068



28720
301.490.0519



28738
301.490.0068



Silencer

28575
301.490.0501

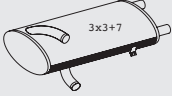

Tail pipe

28350
301.492.0004



28350
301.492.0004



Mounting Parts

1.
00998
071.555.070.501



2.
00995
071.555.073.500



3.
28480
381.492.0082
301.492.0382
0201.175.00



4.
28085
302.490.0080
442.492.0080



5.
28078
384.987.7140
001.987.9640
001.987.5340



6.
28486
301.492.0040



7.
28007



Horizontal
LHD
Standard

Series O 303

Type

O303

WB 5623

Built by Mercedes

►CHno039.438

Not built by Mercedes

►CHno039.676

Baumuster

301.204

301.214

301.224

301.234

301.264

301.274

Front pipe

28724
301.490.0419



28738
301.490.0068



28720
301.490.0519



28738
301.490.0068



Silencer

28575
301.490.0501

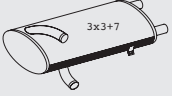

Tail pipe

28350
301.492.0104



28354
301.492.0104



Mounting Parts

1.
00998
071.555.070.501



2.
00995
071.555.073.500



3.
28480
381.492.0082
301.492.0382
0201.175.00



4.
28085
302.490.0080
442.492.0080



5.
28078
384.987.7140
001.987.9640
001.987.5340



6.
28486
301.492.0040



7.
28007



Horizontal
LHD
Standard

Series O 303

Type

O303
 WB 5623
 Built by Mercedes
 039.439 ▶CHno
 Not built by Mercedes
 039.677 ▶CHno

Baumuster

301.204
 301.214
 301.224
 301.234
 301.264
 301.274

Front pipe

28736
301.490.3019



28735
301.492.0059



28737
301.490.2819



28735
301.492.0059



Silencer

28561
301.490.1901

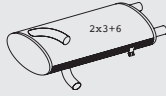

Tail pipe

28354
301.492.0104



28354
301.492.0104



Mounting Parts

1.
00992
071.555.075.502



2.
280480
381.492.0082
301.492.0382
0201.175.00



3.
28085
302.490.0080
442.492.0080



4.
28078
384.987.7140
001.987.9640
001.987.5340



5.
28486
301.492.0040



6.
28007



Horizontal
 LHD
 Standard

Series O 303

Type

O303
WB 5623, 6330

Baumuster

300.414
300.415
300.435
300.484
300.485
300.494
300.495
600.414
600.415
600.484
600.485
600.494
600.495

Front pipe

26669
300.490.0119
301.490.3719



27721
300.490.0059
0201.166.00
300.492.0059



26661
300.490.0219



26662
300.490.0519
0201.161.01



26663
300.490.0619



27721
300.490.0059
0201.166.00
300.492.0059



Silencer

28177
300.490.0001

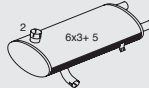

Tail pipe

26952
300.492.0004



26952
300.492.0004



Mounting Parts

1.
28075
0201.178.00
350.492.0080
0201.141.00



2.
00901
071.555.094.502



3.
00942
674.490.2819
303.493.0643
071.555.085.502



4.
28416
300.490.0041



5.
28007



6.
28480
381.492.0082
301.492.0382
0201.175.00



Horizontal
LHD
Standard

Series O 303

Type	Baumuster
O303	301.305
	301.315
WB 6330	301.325
	301.335
	301.365
	301.375

Front pipe

Silencer

Tail pipe

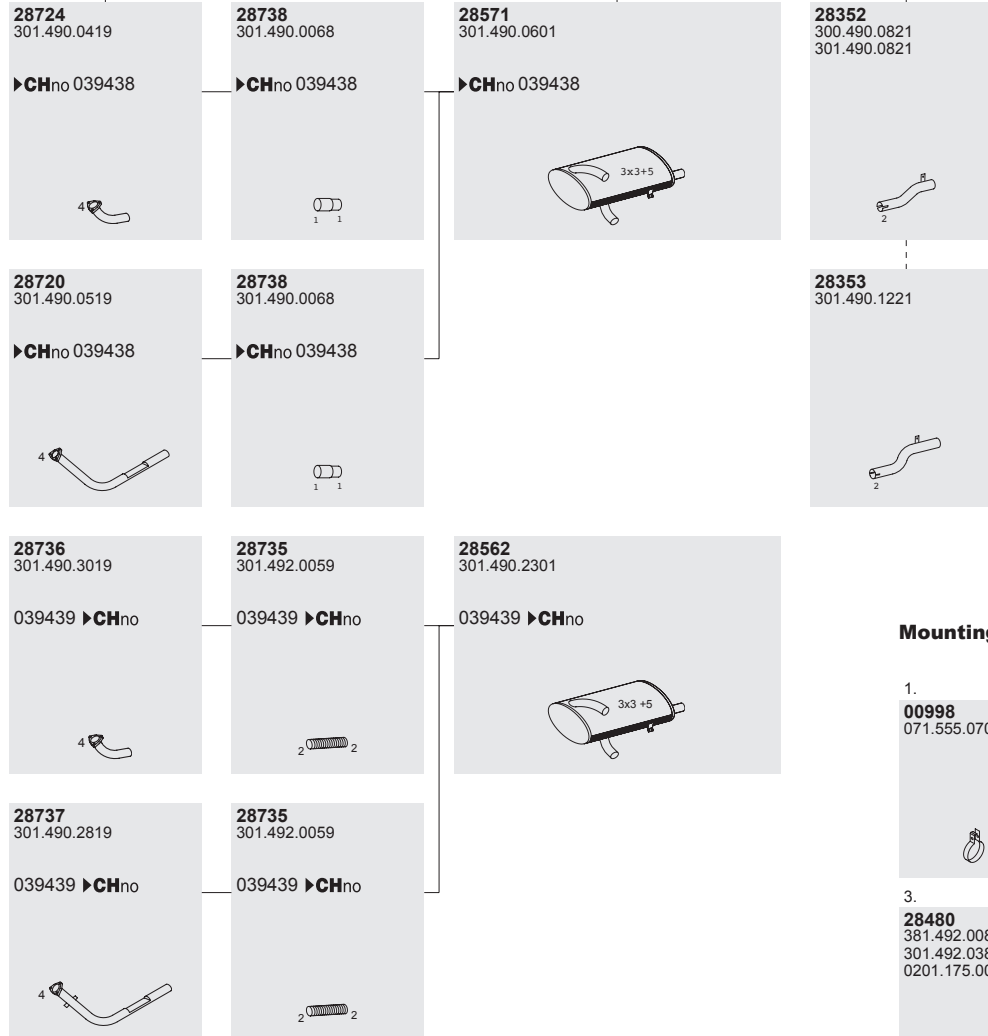

Horizontal
LHD
Standard

Series O 303

Type Baumuster

O303	301.205 301.215
WB 6330	301.225 301.235
Built by Mercedes	301.245 301.265
►CHno039.438	301.275
Not built by Mercedes	
►CHno040.793	

Front pipe

Silencer

Tail pipe

28724
301.490.0419



28738
301.490.0068



28575
301.490.0501

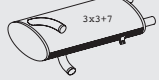

28354
301.492.0104



28720
301.490.0519



28738
301.490.0068



28354
301.492.0104



Mounting Parts

1.
00998
071.555.070.501



2.
00995
071.555.073.500



3.
28480
381.492.0082
301.492.0382
0201.175.00



4.
28085
302.490.0080
442.492.0080



5.
28078
384.987.7140
001.987.9640
001.987.5340



6.
28486
301.492.0040



7.
08007



Horizontal
LHD
Standard

Series O 303

Type

O303
 WB 6330
 Built by Mercedes 039.439 ▶CHno
 Not built by Mercedes 040.794 ▶CHno

Baumuster

301.205
 301.215
 301.225
 301.235
 301.245
 301.265
 301.275

Front pipe

28736
301.490.3019



28735
301.492.0059



28737
301.490.2819



28735
301.492.0059



Silencer

28561
301.490.1901

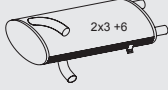

Tail pipe

28354
301.492.0104



28354
301.492.0104



Mounting Parts

1.
28992
071.555.075.502



2.
28480
381.492.0082
301.492.0382
0201.175.00



3.
28085
302.490.0080
442.492.0080



4.
28078
384.987.7140
001.987.9640
001.987.5340



5.
28486
301.492.0040



6.
28007



Horizontal
 LHD
 Standard

Series O 304

Type O304
 Baumuster 373.385

Front pipe

27762
 834.100.0254
 621.490.0065



1 1

27763
 621.492.0008



2

Silencer

28152
 356.490.0201
 356.490.0101

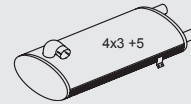

Tail pipe

26937
 613.490.0021
 356.490.0221
 356.490.0121



3

29937
 613.490.0021
 356.490.0221
 356.490.0121



3

Mounting Parts

1.
28410
 621.997.0090



2.
28073
 625.492.0040



3.
00901
 071.555.094.502



4.
28480
 381.492.0082
 301.492.0382
 0201.175.00



5.
28007



Horizontal
 LHD
 Standard

Series O 304

Type O304
Baumuster 373.386

Front pipe

27762
834.100.0254
621.490.0065



27763
621.492.0008



27762
834.100.0254
621.490.0065



27763
621.492.0008



26693
618.492.0201
356.492.1501



28151
356.490.0001

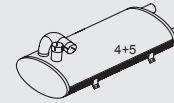

Tail pipe

26937
613.490.0021
356.490.0221
356.490.0121



26937
613.490.0021
356.490.0221
356.490.0121



Mounting Parts

1.
28410
621.997.0090



2.
28073
625.492.0040



3.
00981
071.555.104.501
940.492.0240



4.
28480
381.492.0082
301.492.0382
0201.175.00



5.
28007



Horizontal
LHD
Standard

Series O 305

Type

O305

►CHno004.702

Excluding
004.316, 586,
634, 640, 650,
662, 673

Baumuster

307.000

307.001

Front pipe

27781
307.490.0019



27782
307.492.0101

►CHno 002.330



Silencer

28587
307.490.1601
307.490.1501

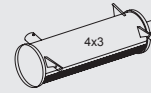

Tail pipe

28997
307.490.5121

BM 307.050, 051, 055
002.331 ►CHno



28319
307.490.5021

BM 307.000, 001
002.331 ►CHno



Mounting Parts

1.
00994
071.555.078.502



2.
00942
674.490.2819
303.493.0643
071.555.085.502



3.
28078
384.987.7140
001.987.9640
001.987.5340



4.
28450
305.492.0182
000.492.0082
357.492.0182



5.
28085
302.490.0080
442.492.0080



Horizontal
LHD
Standard

Series O 305

Type

O305

004.703 ▶CHno
033.192

Including

004, 316, 586,
634, 640, 650,
662, 673
033.380, 388,
409, 437, 460,
485, 510, 534,
535, 546, 558,
559, 570, 588,
589, 610, 620,
621, 641, 649,
650, 669, 678,
679

Baumuster

307.000

307.001

Front pipe

28790
307.490.0219



28747
307.490.0068



28746
307.490.0119



Silencer

28587
307.490.1601
307.490.1501

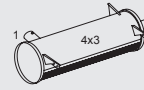

Tail pipe

28319
307.490.5021

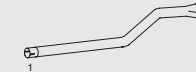

28748
307.490.0319

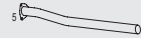

28747
307.490.0068



Mounting Parts

1.
00994
071.555.078.502



2.
00938
071.555.060.500



3.
28078
384.987.7140
001.987.9640
001.987.5340



4.
28450
305.492.0182
000.492.0082
357.492.0182



5.
28072
312.492.1080
442.492.0280



Horizontal
LHD
Standard

Series O 305

Type

O 305

033.193 ▶CHno

Excluding
033.380, 388,
409, 437, 460,
485, 510, 534,
535, 546, 558,
559, 570, 588,
589, 610, 620,
621, 641, 649,
650, 669, 678,
679

Baumuster

307.000

307.001

Front pipe

27789
307.490.0519



27778
307.492.0059



27780
307.490.0719



28587
307.490.1601
307.490.1501

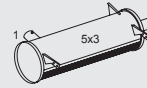

28319
307.490.5021



27784
307.490.0619



27778
307.492.0059



Mounting Parts

1.
00994
071.555.078.502



2.
00935
071.555.063.500



3.
00942
674.490.2819
303.493.0643
071.555.085.502



4.
28078
384.987.7140
001.987.9640
001.987.5340



5.
28450
305.492.0182
000.492.0082
357.492.0182



6.
28072
312.492.1080
442.492.0280



Horizontal
LHD
Standard

Series O 305G

Type

O305 G

►CHno033.192

Including
033.380, 388,
409, 437, 460,
485, 510, 534,
535, 546, 558,
559, 570, 588,
589, 610, 620,
621, 641, 649,
650, 669, 678,
679

Baumuster

307.100

307.101

Front pipe

28790
307.490.0219



28747
307.490.0068



28748
307.490.0319

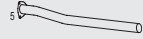

28747
307.490.0068



Silencer

28746
307.490.0119



28587
307.490.1601
307.490.1501

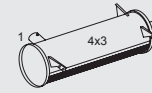

Tail pipe

28319
307.490.5021



Mounting Parts

1.
00994
071.555.078.502



2.
00938
071.555.060.500



3.
28078
384.987.7140
001.987.9640
001.987.5340



4.
28450
305.492.0182
000.492.0082
357.492.0182



5.
28072
312.492.1080
442.492.0280



Horizontal
LHD
Standard

Series O 305G

Type

O305 G
033.193 ▶CHno

Excluding
033.380, 388,
409, 437, 460,
485, 510, 534,
535, 546, 558,
559, 570, 588,
589, 610, 620,
621, 641, 649,
650, 669, 678,
679

Baumuster

307.100
307.101

Front pipe

27789
307.490.0519



27778
307.492.0059



27780
307.490.0719



28587
307.490.1601
307.490.1501

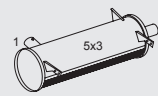

28319
307.490.5021



27784
307.490.0619



27778
307.492.0059



Mounting Parts

1.
00994
071.555.078.502



2.
00935
071.555.063.500



3.
00942
674.490.2819
303.493.0643
071.555.085.502



4.
28078
384.987.7140
001.987.9640
001.987.5340



5.
28450
305.492.0182
000.492.0082
357.492.0182



6.
28072
312.492.1080
442.492.0280



Horizontal
LHD
Standard

Series O 305G

Type	Baumuster
O 305 G	307.100
Gelenkbus	307.101
Turbo	

Front pipeT

27721
300.490.0059
0201.166.00
300.492.0059



Silencer

28599
307.490.1301

►CHno 033.182

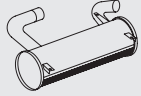

ail pipe

27366
307.490.5621

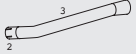

28594
307.490.1801

033.183 ►CHno

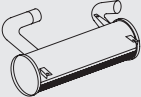

Mounting Parts

1.
00901
071.555.094.502



2.
00981
071.555.104.501
940.492.0240



3.
00988
071.555.100.501
940.492.0340



Horizontal
LHD
Standard

Series O 307

Type

O307

►CHno004.702

Excluding
004.316, 586,
634, 640, 650,
662, 673

Baumuster

307.050

307.051

307.055

Front pipe

27781
307.490.0019



27782
307.492.0101

►CHno 002.330



Silencer

28587
307.490.1601
307.490.1501

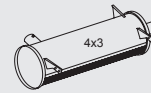

Tail pipe

28997
307.490.5121

►CHno 002.331



Mounting Parts

1.
00994
071.555.078.502



2.
00938
071.555.060.500



3.
28078
384.987.7140
001.987.9640
001.987.5340



4.
28450
305.492.0182
000.492.0082
357.492.0182



5.
28072
312.492.1080
442.492.0280



Horizontal
LHD
Standard

Series O 307

Type

O307

004.703

►CHno033.192

Including

004.316, 586,
634, 640, 650,
662, 673
033.380, 388,
409, 437, 460,
485, 510, 534,
535, 546, 558,
559, 570, 588,
589, 610, 620,
621, 641, 649,
650, 669, 678,
679

Baumuster

307.050

307.051

307.055

Front pipe

28790
307.490.0219



28747
307.490.0068



28746
307.490.0119



28587
307.490.1601
307.490.1501

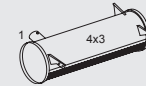

28997
307.490.5121

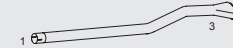

28748
307.490.0319

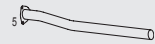

28747
307.490.0068



Mounting Parts

1.
00994
071.555.078.502



2.
00938
071.555.060.500



3.
28078
384.987.7140
001.987.9640
001.987.5340



4.
28450
305.492.0182
000.492.0082
357.492.0182



5.
28072
312.492.1080
442.492.0280



Horizontal
LHD
Standard

Series O 307

Type

O307

033.193 ▶CHno

Excluding
033.380, 388,
409, 437, 460,
485, 510, 534,
535, 546, 558,
559, 570, 588,
589, 610, 620,
621, 641, 649,
650, 669, 678,
679

Baumuster

307.050

307.051

307.055

Front pipe

27789
307.490.0519



27778
307.492.0059



27780
307.490.0719



28587
307.490.1601
307.490.1501

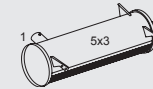

Tail pipe

28997
307.490.5121



27784
307.490.0619

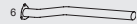

27778
307.492.0059



Mounting Parts

1.
00994
071.555.078.502



2.
00935
071.555.063.500



3.
00942
674.490.2819
303.493.0643
071.555.085.502



4.
28078
384.987.7140
001.987.9640
001.987.5340



5.
28450
305.492.0182
000.492.0082
357.492.0182



6.
28072
312.492.1080
442.492.0280



Horizontal
LHD
Standard

Series O 309D

Type

O 309 D

►CHno 246.272
556.500 ►CHno

Baumuster

310.389

Front pipe

Silencer

Tail pipe

28649
310.490.0819

►CHno 246.272



28586
314.490.0501



28975
309.492.3301

►CHno 246.272



28921
309.492.6204



28922
309.492.6304



28642
310.490.1119

556.500 ►CHno



28925
310.492.2204

556.500 ►CHno



Mounting Parts

1.
00925
071.555.053.500



2.
28461
318.491.0041



3.
28081
309.490.0037



4.
28071
917.003.060003



Horizontal
LHD
Standard

Series O 309D

Type

O 309 D

246.273 ▶CHno
556.499

Baumuster

310.389

Front pipe



Silencer

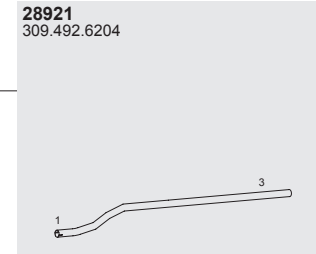
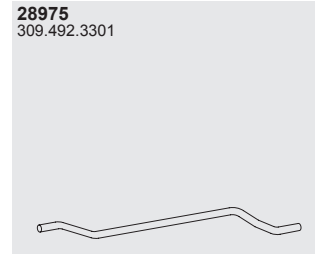
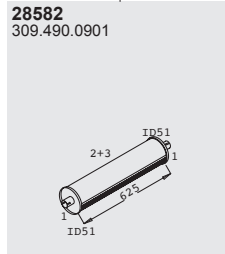

Tail pipe

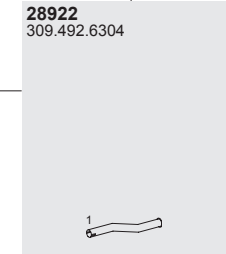

Mounting Parts

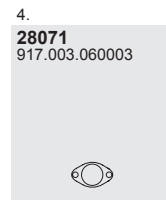
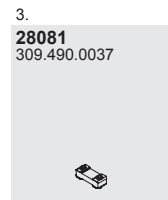
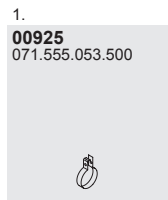

Horizontal
LHD
Standard

Series O 309D

Type

O 309 D
WB 2950, 3500
028.345 ▶CHno

Baumuster

309.170
309.171
309.172
309.173
309.182
309.183
309.190
309.191

Front pipeT

Silencer

ail pipe

28620
309.490.2519

028.345 ▶CHno 349.453

28582
309.490.0901

▶CHno 556.499

28300
309.492.5404
309.492.7504

028.345 ▶CHno 349.453

27779
309.490.3319

349.454 ▶CHno 556.499

28586
314.490.0501

556.500 ▶CHno

28973
309.492.7004

349.454 ▶CHno 556.499

27773
309.492.6801

556.500 ▶CHno

28978
310.492.1504

556.500 ▶CHno

Mounting Parts

1.
00925
071.555.053.500

2.
28461
318.491.0041

3.
28081
309.490.0037

4.
00928
071.555.050.500
492.431.0043

5.
28428
309.491.0041

Horizontal
LHD
Standard

Series O 309D

Type	Baumuster
O 309 D	309.370
	309.371
WB 2950, 3500	309.372
	309.373
028.133 ▶CHno	309.382
245.341	309.383
	309.390
	309.391

Front pipeT

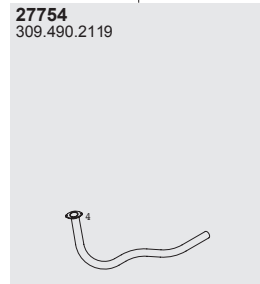

Silencer

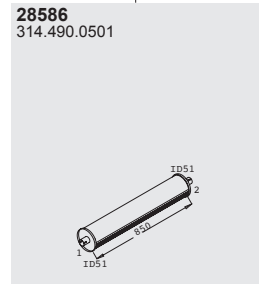

ail pipe

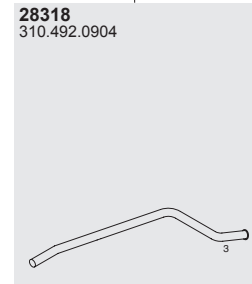

Mounting Parts

1. ▶CHno 055.352
00924
071.555.058.501



1. 055.353 ▶CHno
00925
071.555.053.500



2.
00928
071.555.050.500
492.431.0043

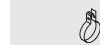

3.
28081
309.490.0037

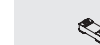

4.
28071
917.003.060003



Horizontal
LHD
Standard

Series O 309D

Type

O 309 D
WB 2950, 3500
245.342 ▶CHno
556.499

Baumuster

309.370
309.371
309.372
309.373
309.382
309.383
309.390
309.391

Front pipeT

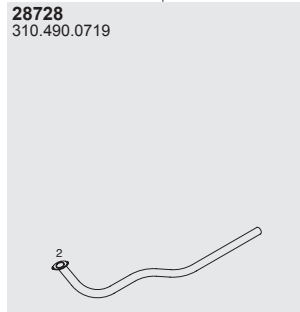

Silencer

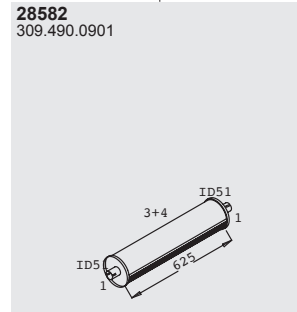

ail pipe

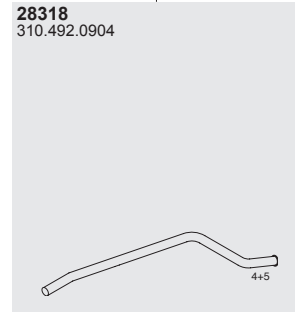

Mounting Parts

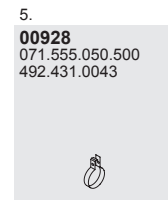
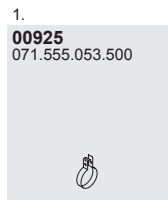

Horizontal
LHD
Standard

Series O 309D

Type	Baumuster
O 309 D	309.370 309.372
WB 2950, 3500	309.382 309.390
556.500 ▶CHno	309.391

Front pipeT

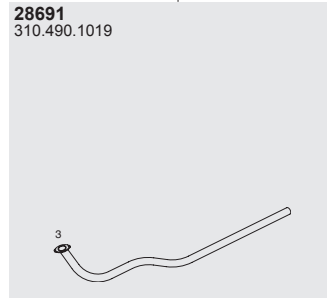

Silencer

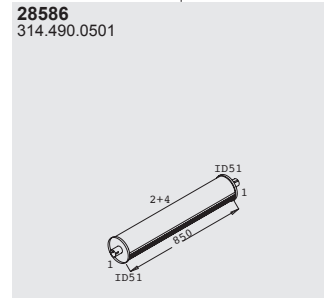

ail pipe

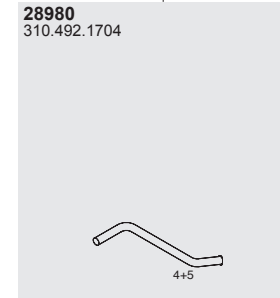

Mounting Parts

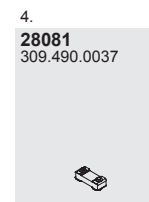
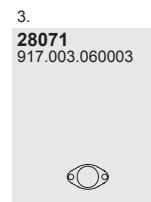
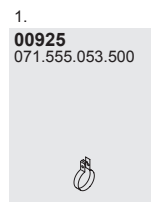

Horizontal
LHD
Standard

Series O 309D

Type

O 309 D
 WB 3500, 4100
 OM 352
 5,7l tr.
 6 cyl.
 66 KW/90H P

Baumuster

313.382
 313.386

►CHno352.290
 Excl. 350.368,
 793, 843, 954,
 351.074, 169,
 284, 434, 903,
 352.271, 272
 Incl. 352.759,
 353.163, 868,
 354.161

Front pipe

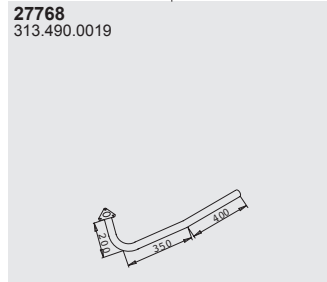

Silencer

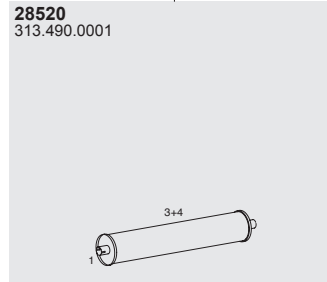

Tail pipe

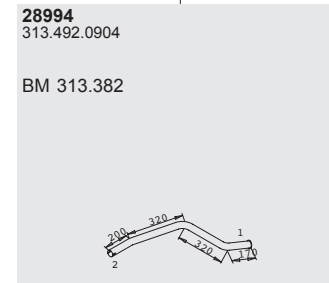
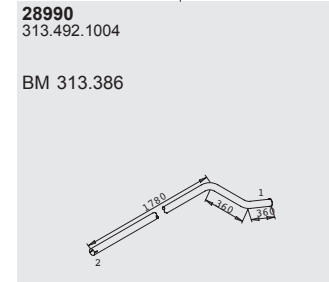

Mounting Parts

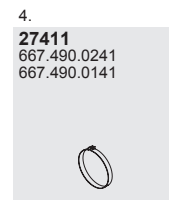
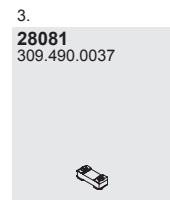
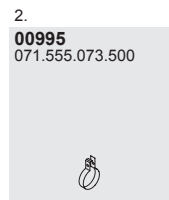
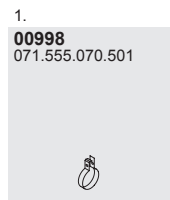

Horizontal
 LHD
 Standard

Series O 309D

Type

O 309 D
WB 3500, 4100
OM 352
5,7l tr.
6 cyl.
66 KW/90H P

352.291 ▶CHno
564.535
Incl. 350.368,
793, 843, 954,
351.074, 169,
284, 434, 903,
352.271, 272
Excl. 352.759,
353.163, 868,
354.161

Baumuster

313.382
313.386
313.389

Front pipe

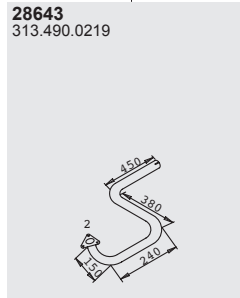

Silencer

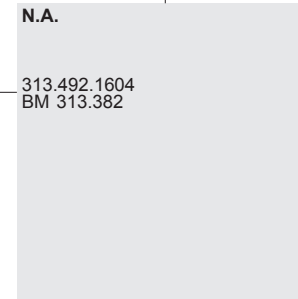
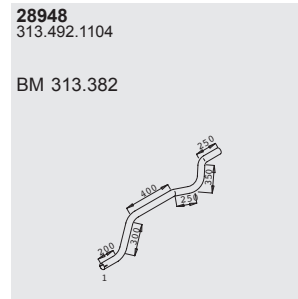
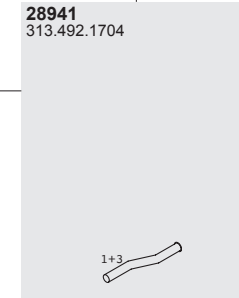
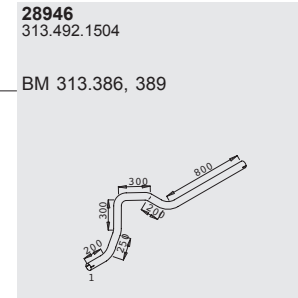
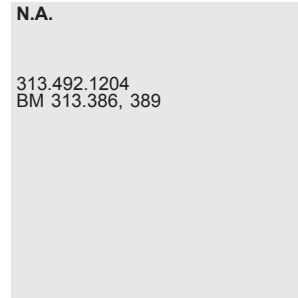

Mounting Parts

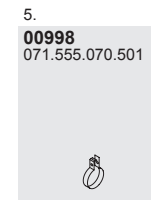
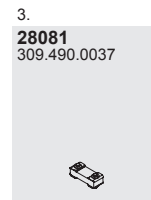
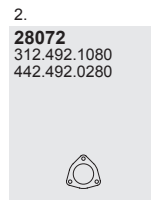
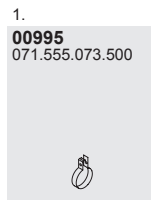

Horizontal
LHD
Standard

Series O 309D

Type Baumuster

O 309 D 313.382
 WB 3500, 4100 313.386
 313.389
 564.536 ▶CHno

Front pipe

Silencer

Tail pipe

27767
 313.490.0319



28520
 313.490.0001

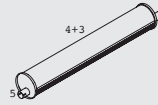

28943
 313.492.2604

BM 313.386, 389

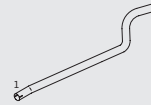

28946
 313.492.1504

BM 313.386, 389



28941
 313.492.1704



Mounting Parts

1.
00992
 071.555.075.502



2.
28072
 312.492.1080
 442.492.0280



3.
28081
 309.490.0037



4.
28461
 318.491.0041



5.
00998
 071.555.070.501



Horizontal
 LHD
 Standard

Series O 309D

Type

O 309 D

WB 4100

►CHno246.272

Baumuster

310.386

Silencer

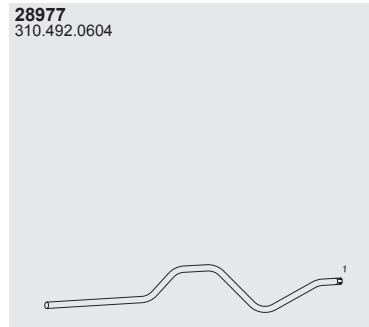

Tail pipe

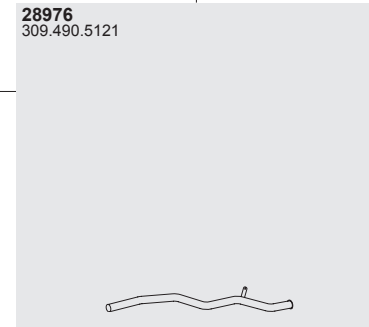

Mounting Parts

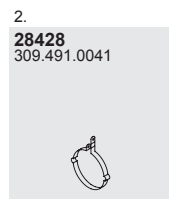
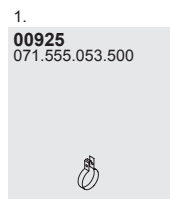

Horizontal
LHD
Standard

Series O 309D

Type
O 309 D
WB 4100
246.273 ▶CHno

Baumuster
310.386

Front pipeT

Silencer

ail pipe

28728
310.490.0719

246.273 ▶CHno 556.499

28582
309.490.0901

246.273 ▶CHno 556.499

28314
310.492.1004

246.273 ▶CHno 556.499

28691
310.490.1019

556.500 ▶CHno

28586
314.490.0501

556.500 ▶CHno

28954
310.492.1604

556.500 ▶CHno

Mounting Parts

1.
00925
071.555.053.500

2.
28461
318.491.0041

3.
28428
309.491.0041

4.
28081
309.490.0037

5.
00928
071.555.050.500
492.431.0043

6.
28071
917.003.060003

Horizontal
LHD
Standard

Series O 309D

Type	Baumuster
O 309 D	310.386
WB 4100	310.389
246.273 ▶CHno	
556.499	

Front pipeT

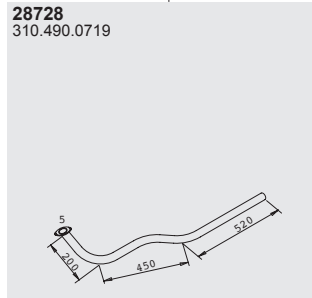

Silencer

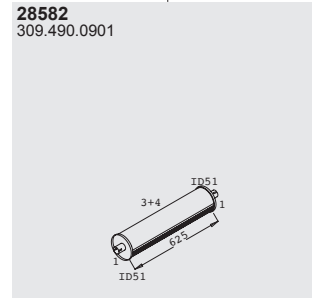

ail pipe

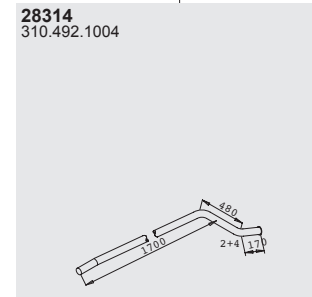
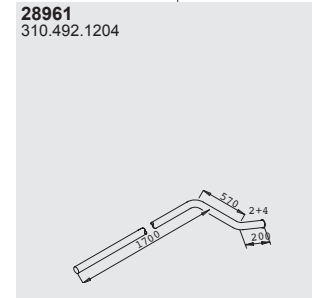

Mounting Parts

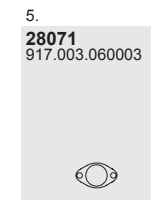
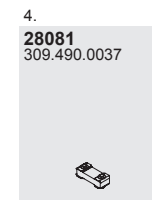
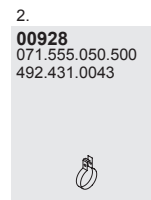
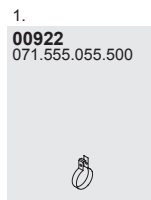

Horizontal
LHD
Standard

Series O 309D

Type

O 309 D
WB 4100
556.500 ▶CHno

Baumuster

310.386
310.389

Front pipe

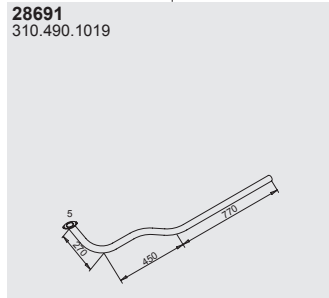

Silencer



Tail pipe

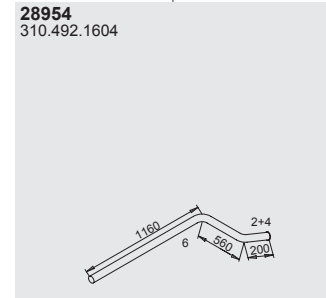

Mounting Parts

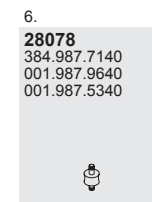
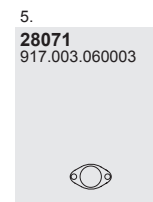
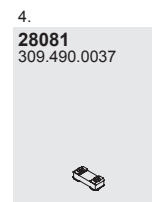
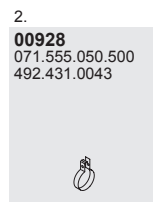
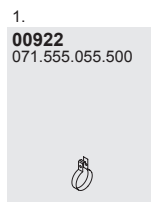

Horizontal
LHD
Standard

Series O 330

Type O330
 Baumuster 600.345

Front pipe

28736
301.490.3019



28735
301.492.0059



21725
600.490.0219



27721
300.490.0059
0201.1666.00
300.492.0059



Silencer

28140
600.490.0001

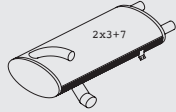

Tail pipe

21366
373.492.7204



21366
373.492.7204



Mounting Parts

1.
00995
071.555.073.500



2.
28480
381.492.0082
301.492.0382
0201.175.00



3.
28085
302.490.0080
442.492.0080



4.
28078
384.987.7140
001.987.9640
001.987.5340



5.
28486
301.492.0040



6.
00901
071.555.094.502



7.
28007



Horizontal
LHD
Standard

Series O 340

Type

Euro I



Baumuster

600.342

600.344

Front pipe

27762
834.100.0254
621.490.0065



27763
621.492.0008



Silencer

28152
356.490.0201
356.490.0101

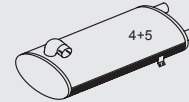

Tail pipe

26937
613.490.0021
356.490.0221
356.490.0121



26937
613.490.0021
356.490.0221
356.490.0121



Mounting Parts

1.
28410
621.997.0090



2.
28073
625.492.0040



3.
00901
071.555.094.502



4.
28480
381.492.0082
301.492.0382
0201.175.00



5.
28007



Horizontal
LHD
Standard

Series O 340

Type

Euro I



Baumuster

600.442

Front pipe

27762
834.100.0254
621.490.0065



27763
621.492.0008



26693
618.492.0201
356.492.1501



28151
356.490.0001

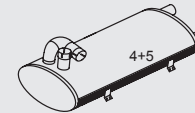

Tail pipe

26937
613.490.0021
356.490.0221
356.490.0121



27762
834.100.0254
621.490.0065



27763
621.492.0008



26937
613.490.0021
356.490.0221
356.490.0121



Mounting Parts

1.
28410
621.997.0090



2.
28073
625.492.0040



3.
00981
071.555.104.501
940.492.0240



4.
28480
381.492.0082
301.492.0382
0201.175.00



5.
28007



Horizontal
LHD
Standard

Series O 350

Type

Euro II



4X2

O 350
Tourismo

OM 441 LA
12,0l tr.
6 cyl.
250 KW/340 HP

Baumuster

613.355
613.385

Front pipe

27762
834.100.0254
621.490.0065



27763
621.492.0008



Silencer

28152
356.490.0201
356.490.0101

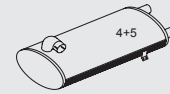

Tail pipe

26937
613.490.0021
356.490.0221
356.490.0121



26937
613.490.0021
356.490.0221
356.490.0121



Mounting Parts

1.
28410
621.997.0090



2.
28073
625.492.0040



3.
00901
071.555.094.502



4.
28480
381.492.0082
301.492.0382
0201.175.00



5.
28007



Horizontal
LHD
Standard

Series O 350

Type

Euro II



O 350
Tourismo

OM 402 LA
13,0l tr.
8 cyl.
280 KW/381 HP

OM 442 LA
14,7l tr.
8 cyl.
280 KW/381 HP

Baumuster

613.455

613.485

Front pipe

27762
834.100.0254
621.490.0065



27763
621.492.0008



26693
618.492.0201
356.492.1501



27762
834.100.0254
621.490.0065



27763
621.492.0008



Silencer

28151
356.490.0001

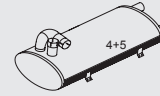

28102
618.490.0301

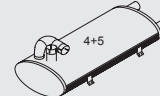

Tail pipe

26937
613.490.0021
356.490.0221
356.490.0121



26937
613.490.0021
356.490.0221
356.490.0121



Mounting Parts

1.
28410
621.997.0090



2.
28073
625.492.0040



3.
00981
071.555.104.501
940.492.0240



4.
28480
381.492.0082
301.492.0382
0201.175.00



5.
28007



Horizontal
LHD
Standard

Series O 402

Type Baumuster

10/86 → 12/91 697.051



④X②

Stadtomnibus
WB 4000

OM 366
6,0l tr.
6 cyl.
100 KW/136 HP

►CHno950.099
Incl.
950.122-950.125,
950.142



Front pipe

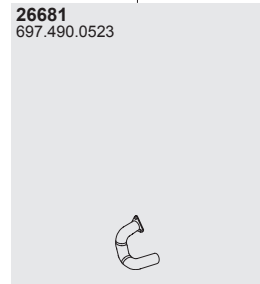

Silencer



Tail pipe

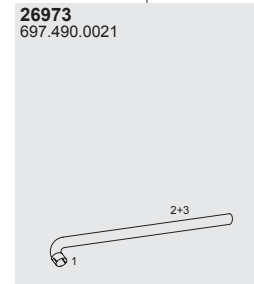

Mounting Parts

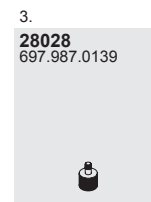
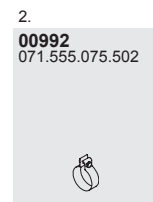
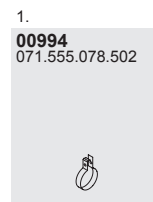

Horizontal
LHD
Standard

Series O 402

Type

10/86 → 12/91



4X2

Stadtomnibus
WB 4000

OM 366 A
6,0l tr.
6 cyl.
125 KW/170 HP

CHno950.148



Baumuster

697.056

Front pipe

28679
620.490.0365



N.A.

697.490.0023

Silencer

28178
425.490.0101

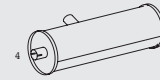

Tail pipe

26973
697.490.0021



Mounting Parts

1.
28478
620.997.0490



2.
00992
071.555.075.502



3.
28028
697.987.0139



4.
00994
071.555.078.502



Horizontal
LHD
Standard

Series O 402

Type

10/86 → 12/91



Stadtnibus
WB 4000

OM 366 A
6,0l tr.
6c yl.
125 KW/170 HP

950.149 ▶CHno



Baumuster

697.056

Front pipe

28699
620.490.0465



N.A.

697.490.0123

Silencer

28179
697.490.0401

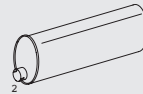

Tail pipe

26979
697.490.0621



Mounting Parts

1.
28426
620.997.0590



2.
00940
071.555.090.501
395.492.0040
645.492.1140



3.
28081
309.490.0037



Horizontal
LHD
Standard

Series O 404

Type

Euro II
09/91 → 10/99



OM 441 LA
11,0 ltr.
6 cyl.
213 KW/290 HP

Baumuster

- 618.000
- 618.003
- 618.005
- 618.010
- 618.015
- 618.020
- 618.023
- 618.025
- 618.030
- 618.035
- 618.103
- 618.105
- 618.113
- 618.115
- 618.125
- 618.133

Front pipe

25771
357.492.0959



26693
618.492.0201
356.492.1501



Silencer

28103
618.490.0501

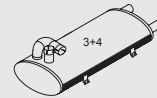

Tail pipe

26937
613.490.0021
356.490.0221
356.490.0121



25771
357.492.0959



26937
613.490.0021
356.490.0221
356.490.0121



Mounting Parts

1.
00587
357.492.1240



2.
00981
071.555.104.501
940.492.0240



3.
28480
381.492.0082
301.492.0382
0201.175.00







4.
28007



Horizontal
LHD
Standard

Series O 404

Type	Baumuster
Euro II	356.030 614.115
09/91 → 10/99	356.100 614.313
	356.103 614.315
	356.105 614.345
	356.110
	356.113
WB 2600, 4585, 5245, 5250, 6250	356.115
	356.120
	356.123
	356.125
 OM 401 LA	356.130
9,6l tr.	356.133
6 cyl.	356.135
151 KW/205 HP	356.140
165 KW/224 HP	356.143
200 KW/272 HP	356.145
213 KW/290 HP	356.150
 OM 441 LA	356.153
11,0 ltr.	356.155
6 cyl.	356.160
250 KW/340 HP	356.163
	356.165
	356.170
	356.173
	356.175
	356.303
	356.305
	356.313
	356.315
	356.323
	356.325
	356.333
	356.335
	356.343
	356.345
	356.353
	356.355
	356.363
	356.365
	356.373
	356.375
	356.385
	356.395

Horizontal
LHD
Standard

Front pipe

27762
834.100.0254
621.490.0065



27763
621.492.0008



Silencer

28152
356.490.0201
356.490.0101

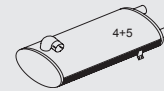

Tail pipe

26937
613.490.0021
356.490.0221
356.490.0121



26937
613.490.0021
356.490.0221
356.490.0121



Mounting Parts

1.
28410
621.997.0090



2.
28073
625.492.0040



3.
00901
071.555.094.502



4.
28480
381.492.0082
301.492.0382
0201.175.00



5.
28007



Series O 404

Type

Euro II
09/91 → 10/99

WB 5245, 6250
 **OM 442 LA**
14,7l tr.
8 cyl.
213 KW/290 HP
 **OM 402 LA**
12,8l tr.
8 cyl.
280 KW/381 HP

Baumuster

356.225
356.235
356.255
356.303
356.313
356.323
356.333
356.343
356.353
356.363
356.373
356.403
356.405
356.406
356.413
356.415
356.425
356.435
356.443
356.445
356.455
356.465
356.473
356.475
356.485
356.495
614.313
614.413
614.415
614.435
614.445
614.448

Front pipe

27762
834.100.0254
621.490.0065



27763
621.492.0008



26693
618.492.0201
356.492.1501



28151
356.490.0001

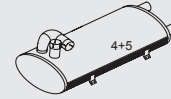

Tail pipe

26937
613.490.0021
356.490.0221
356.490.0121



27762
834.100.0254
621.490.0065



27763
621.492.0008



26937
613.490.0021
356.490.0221
356.490.0121



Mounting Parts

1.
28410
621.997.0090



2.
28073
625.492.0040



3.
00981
071.555.104.501
940.492.0240



4.
28480
381.492.0082
301.492.0382
0201.175.00



5.
28007



Horizontal
LHD
Standard

Series O 404

Type

Euro II
09/91 → 10/99

WB 5245, 6250
 **OM 442 LA**
14,7l tr.
8 cyl.
280 KW/381 HP

Baumuster

356.000
614.428
618.203
618.205
618.213
618.215
618.223
618.225
618.233
618.238
618.335
618.345

Front pipe

27762
834.100.0254
621.490.0065



27263
621.492.0008



26693
618.492.0201
356.492.1501



28102
618.490.0301

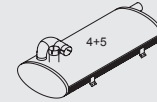

Tail pipe

26937
613.490.0021
356.490.0221
356.490.0121



27762
834.100.0254
621.490.0065



27763
621.492.0008



26937
613.490.0021
356.490.0221
356.490.0121



Mounting Parts

1.
28410
621.997.0090



2.
28073
625.492.0040



3.
00981
071.555.104.501
940.492.0240



4.
28480
381.492.0082
301.492.0382
0201.175.00



5.
28007



Horizontal
LHD
Standard

Series O 405

Type

Euro I
12/84 →



OM 447 HLA
12,0l tr.
6 cyl.
157 KW/213 HP
184 KW/250 HP
220 KW/300 HP

►CHno076650

Baumuster

612.000
612.001
612.010
612.011
612.020
612.021

Front pipe

27766
357.490.1319



28679
620.490.0365



28674
620.492.0008
617.492.0008



27765
357.490.1419



28679
620.490.0365



28674
620.492.0008
617.492.0008



Silencer

28524
357.490.0301
357.490.1801

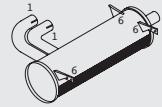

Tail pipe

28949
357.492.1204

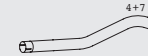

Mounting Parts

1.
00992
071.555.075.502



2.
00901
071.555.094.502



3.
28478
620.997.0490



4.
00942
674.490.2819
303.493.0643
071.555.085.502



5.
28085
302.490.0080
442.492.0080



6.
28450
305.492.0182
000.492.0082
357.492.0182



7.
28089
322.504.0212



Horizontal
LHD
Standard

Series O 405

Type

Euro I
12/84 →



OM 447 HLA
12,0l tr.
6 cyl.
157 KW/213 HP
184 KW/250 HP
220 KW/300 HP

076651 ▶CHno

Baumuster

612.000
612.001
612.010
612.011
612.020
612.021

Front pipe

Silencer

Tail pipe

25776
357.490.5519

25777
357.492.0859

28524
357.490.0301
357.490.1801

28949
357.492.1204

25775
357.490.5619

25777
357.492.0859

Mounting Parts

1.
28085
302.490.0080
442.492.0080

2.
00901
071.555.094.502

3.
00699T

4.
00942
674.490.2819
303.493.0643
071.555.085.502

5.
28089
322.504.0212

6.
28450
305.492.0182
000.492.0082
357.492.0182

Horizontal
LHD
Standard

Series O 405G

Type

Euro I
12/84 →



Stadtmobus
Gelenkzug

WB 5625, 6175

OM 427 H
12,0l tr.
6c yl.
177 KW/240 HP

OM 447 H
12,0l tr.
6c yl.
177 KW/240 HP

►CHno069463

Baumuster

357.200
357.201

Front pipe

27766
357.490.1319

28679
620.490.0365

28674
620.492.0008
617.492.0008

27765
357.490.1419

28679
620.490.0365

28674
620.492.0008
617.492.0008

Silencer

28524
357.490.0301
357.490.1801

Tail pipe

28949
357.492.1204

Mounting Parts

1.
00992
071.555.075.502

2.
00901
071.555.094.502

3.
28478
620.997.0490

4.
00942
674.490.2819
303.493.0643
071.555.085.502

5.
28085
302.490.0080
442.492.0080

6.
28450
305.492.0182
000.492.0082
357.492.0182

7.
28089
322.504.0212

Horizontal
LHD
Standard

Series O 405G

Type

Euro II
11/85 →



WB 5625, 6175

OM 427 HA
12,0l tr.
6 cyl.
206 KW/280 HP

OM 447 HA
12,0l tr.
6 cyl.
206 KW/280 HP

OM 447 HLA
12,0l tr.
6 cyl.
220 KW/300 HP

069464 ▶CHno

Baumuster

357.210
357.211

Front pipe

Silencer

25772
357.490.5419

076551 ▶CHno



25771
357.492.0959

076651 ▶CHno



28598
357.490.1901

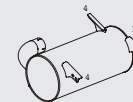

27761
357.490.1619

▶CHno 076650



27762
834.100.0254
621.490.0065

▶CHno 076650



27763
621.492.0008

▶CHno 076650



N. A.

357.490.0501

▶CHno 076650

Mounting Parts

1.
00981
071.555.104.501
940.492.0240



2.
28410
621.997.0090



3.
28073
625.492.0040



4.
28450
305.492.0182
000.492.0082
357.492.0182



5.
00587
357.492.1240



Horizontal
LHD
Standard

Series O 405G

Type

Baumuster

Euro II
11/85 →

357.200



357.201



612.312

612.322

612.323

WB 6150

OM 427 H
12,0l tr.
6 cyl.
177 KW/240 HP

OM 447 H
12,0l tr.
6 cyl.
177 KW/240 HP

OM 447 HLA
12,0l tr.
6 cyl.
184 KW/250 HP
220 KW/300 HP

Front pipe

Silencer

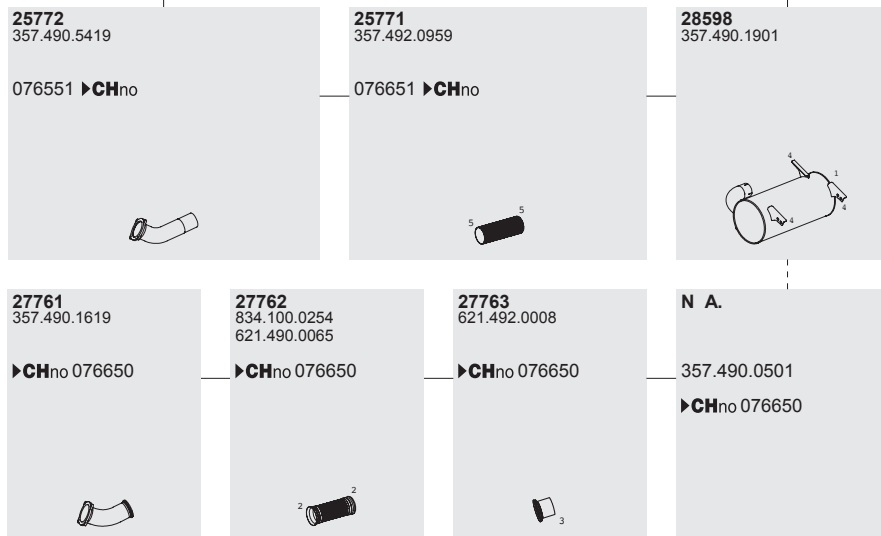

Mounting Parts

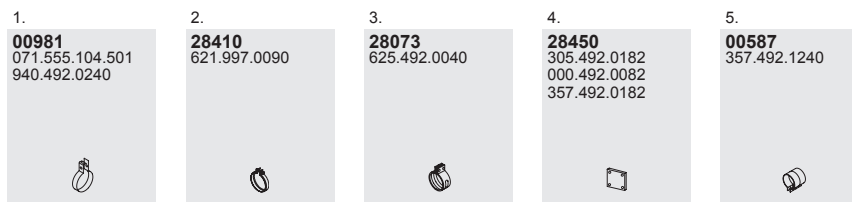

Horizontal
LHD
Standard

Series O 405GN

Type Baumuster

Euro I	357.530
11/85 →	357.532
	357.540
	357.542
	612.512
	612.514
O 405 GN	612.522
O 405 GN	612.523
O 405 GN 2	612.524
Stadtomnibus	612.525
Gelenkzug	357.550
	357.560
WB 5725, 6175	357.562

OM 447 HA
12,0l tr.
6 cyl.
184 KW/ 250 HP

OM 447 HLA
12,0l tr.
6 cyl.
184 KW/250 HP
220 KW/300 HP

Front pipe

27762
834.100.0254
621.490.0065



26695
357.490.3919
357.490.3419
357.490.3719



Silencer

28155
357.490.1501
357.490.1102
357.490.0701

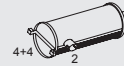

Tail pipe

26924
357.490.2621

Ceramic insulation



Mounting Parts

1.
28410
621.997.0090



2.
00981
071.555.104.501
940.492.0240



2. BM 612.522
00587
357.492.1240



3.
00988
071.555.100.501
940.492.0340



4.
28480
381.492.0082
301.492.0382
0201.175.00



4. BM 612.522
28084
300.492.0082



Horizontal
LHD
Standard

Series O 405GT

Type

Euro I
11/85 →



OM 447 H
12,0l tr.
6 cyl.
157 KW/213 HP

OM 447 HA
12,0l tr.
6 cyl.
184 KW/250 HP

▶CHno069463

Baumuster

357.250
357.251

Front pipe

27766
357.490.1319

28679
620.490.0365

28674
620.492.0008
617.492.0008

27765
357.490.1419

28679
620.490.0365

28674
620.492.0008
617.492.0008

Silencer

28524
357.490.0301
357.490.1801

Tail pipe

28949
357.492.1204

Mounting Parts

1.
00992
071.555.075.502

2.
00901
071.555.094.502

3.
28478
620.997.0490

4.
00942
674.490.2819
303.493.0643
071.555.085.502

5.
28085
302.490.0080
442.492.0080

6.
28450
305.492.0182
000.492.0082
357.492.0182

7.
28089
322.504.0212

Horizontal
LHD
Standard

Series O 405GTD

Type

Euro I
11/85 →



OM 447 HA
12,0l tr.
6 cyl.
184 KW/250 HP

OM 447 HLA
12,0l tr.
6 cyl.
220 KW/300 HP

069465 ▶CHno

Baumuster

357.250
357.260

Front pipe

25772
357.490.5419

076551 ▶CHno

25771
357.492.0959

076651 ▶CHno

27761
357.490.1619

▶CHno 076650

27762
834.100.0254
621.490.0065

▶CHno 076650

27763
621.492.0008

▶CHno 076650

Silencer

28598
357.490.1901

076651 ▶CHno

N. A.

357.490.0501

▶CHno 076650

Tail pipe

28944
357.492.2604

BM 357.250

Mounting Parts

1.
00981
071.555.104.501
940.492.0240

2.
28410
621.997.0090

3.
28073
625.492.0040

4.
28450
305.492.0182
000.492.0082
357.492.0182





5.
00587
357.492.1240

6.
28089
322.504.0212

Horizontal
LHD
Standard

Series O 405N

Type Baumuster

Euro I	357.400
12/84 →	357.401
	357.402
	357.404
	357.406
	357.410
Stadtomnibus	357.415
	612.400
WB 5875	612.401
	612.402
	612.403
12,0l tr.	612.410
6 cyl.	612.411
150 KW/204 HP	612.412
157 KW/213 HP	612.413
177 KW/240 HP	612.420
	612.422
12,0l tr.	357.420
6 cyl.	357.422
184 KW/250 HP	357.454
	357.455
	357.460
12,0l tr.	357.461
6 cyl.	357.464
157 KW/213 HP	357.465
184 KW/250 HP	357.470
220 KW/300 HP	357.474

Front pipe

27762
834.100.0254
621.490.0065



26695
357.490.3919
357.490.3419
357.490.3719
Insulated
Excl.B M 357.400-402, 404, 406,
410, 415, 420, 422, 454, 455, 460



26692
357.490.3019
357.490.2619
BM 357.400-402, 404, 406, 410,
415, 420, 422, 454, 455, 460

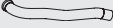

Silencer

28155
357.490.1501
357.490.1102
357.490.0701

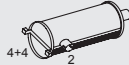

Tail pipe

26924
357.490.2621
Ceramics insulation



26938
357.492.3304
BM 357.400-402, 404, 406, 410,
415



Mounting Parts

1.
28410
621.997.0090



2.
00981
071.555.104.501
940.492.0240



3.
00988
071.555.100.501
940.492.0340



4.
28480
381.492.0082
301.492.0382
0201.175.00



Horizontal
LHD
Standard

Series O 405NU

Type Baumuster

Euro I 612.416
11/85 → 612.426



Stadtomnibus

WB 5875

OM 447 HA
12,0l tr.
6 cyl.
184 KW/250 HP

OM 447 HLA
12,0l tr.
6 cyl.
184 KW/250 HP
220 KW/300 HP

Horizontal
LHD
Standard

Front pipe

27762
834.100.0254
621.490.0065



26695
357.490.3919
357.490.3419
357.490.3719



Silencer

28155
357.490.1501
357.490.1102
357.490.0701

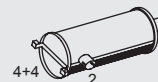

Tail pipe

26924
357.490.2621

Ceramic insulation



Mounting Parts

1.
28410
621.997.0090



2.
00981
071.555.104.501
940.492.0240



3.
00988
071.555.100.501
940.492.0340



4.
28480
381.492.0082
301.492.0382
0201.175.00



Series O 405ST

Type

Euro I
12/84 →



Stadtomnibus

WB 5875

OM 447 H
12,0l tr.
6 cyl.
177 KW/240 HP

OM 447 HA
12,0l tr.
6 cyl.
184 KW/250 HP
206 KW/ 280 HP

OM 447 HLA
12,0l tr.
6 cyl.
220 KW/300 HP

Baumuster

357.004
357.005
357.010
357.011

Front pipe

Silencer

25772
357.490.5419

076551 ▶CHno



25771
357.492.0959

076651 ▶CHno



28598
357.490.1901

076651 ▶CHno

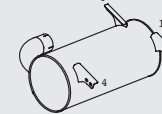

26761
357.490.1619

▶CHno 076650



26762
834.100.0254
621.490.0065

▶CHno 076650



26763
621.492.0008

▶CHno 076650



N. A.

357.490.0501

▶CHno 076650

Mounting Parts

1.
00981
071.555.104.501
940.492.0240



2.
28410
621.997.0090



3.
28073
625.492.0040



4.
28450
305.492.0182
000.492.0082
357.492.0182



5.
00587
357.492.1240



Horizontal
LHD
Standard

Series O 405ST

Type

Baumuster

Euro I
12/84 →

357.000
357.001
357.002



Stadtomnibus

WB 5875

OM 447 H
12,0l tr.
6 cyl.
150 KW/204 HP
157 KW/213 HP

OM 427 H
12,0l tr.
6 cyl.
150 KW/204 HP
177 KW/240 HP

OM 427 HA
12,0l tr.
6 cyl.
206 KW/280 HP

CHno076650

Front pipe

Silencer

Tail pipe

27766
357.490.1319



28679
620.490.0365



28674
620.492.0008
617.492.0008



28524
357.490.0301
357.490.1801

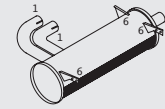

28949
357.492.1204

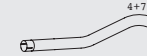

27765
357.490.1419

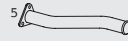

28679
620.490.0365



28764
620.492.0008
617.492.0008



Mounting Parts

1.
00992
071.555.075.502



2.
00901
071.555.094.502



3.
28478
620.997.0490



4.
00942
674.490.2819
303.493.0643
071.555.085.502



5.
28085
302.490.0080
442.492.0080



6.
28450
305.492.0182
000.492.0082
357.492.0182



7.
28089
322.504.0212



Horizontal
LHD
Standard

Series O 405ST

Type

Euro I
12/84 →



Stadtomnibus

WB 5875

OM 447 H
12,0l tr.
6 cyl.
150 KW/204 HP
157 KW/213 HP

OM 427 H
12,0l tr.
6 cyl.
150 KW/204 HP
177 KW/240 HP

OM 427 HA
12,0l tr.
6 cyl.
206 KW/280 HP

076651 ▶CHno

Baumuster

357.000
357.001
357.002

Front pipe

25776
357.490.5519

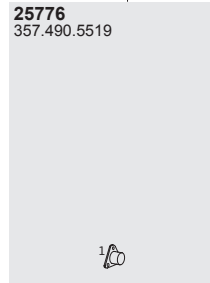

25777
357.492.0859

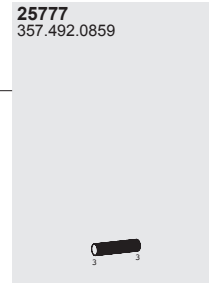

25775
357.490.5619

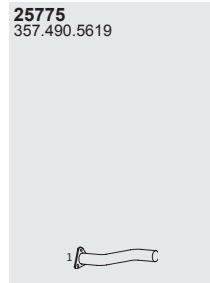

25777
357.492.0859

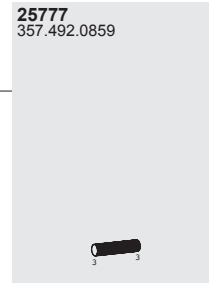

Silencer

28524
357.490.0301
357.490.1801

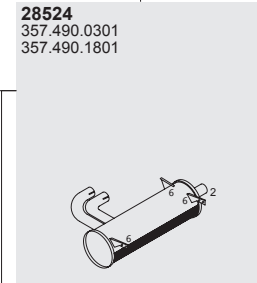

Tail pipe

28949
357.492.1204

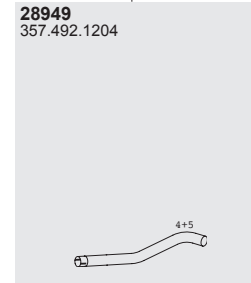

Mounting Parts

1.
28085
302.490.0080
442.492.0080

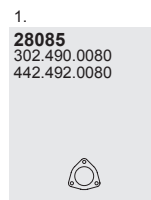

2.
00901
071.555.094.502

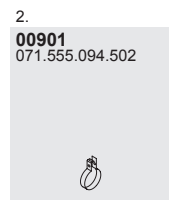

3.
00699T

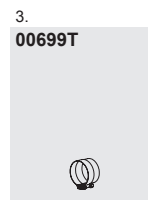

4.
00942
674.490.2819
303.493.0643
071.555.085.502



5.
28089
322.504.0212

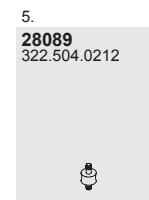

6.
28450
305.492.0182
000.492.0082
357.492.0182

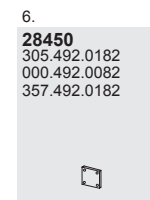

Horizontal
LHD
Standard

Series O 407

Type

Euro II
03/87 → 11/01



OM 447 HLA
12,0l tr.
6 cyl.
184 KW/250 HP
220 KW/300 HP

069464 ▶CHno

Baumuster

612.110
612.116
612.120
612.126

Front pipe

Silencer

25772
357.490.5419

076551 ▶CHno



25771
357.492.0959

076651 ▶CHno



28598
357.490.1901

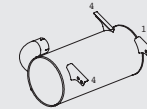

27761
357.490.1619

▶CHno 076650



27762
834.100.0254
621.490.0065

▶CHno 076650



27763
621.492.0008

▶CHno 076650



N. A.

357.490.0501

▶CHno 076650

Mounting Parts

1.
00981
071.555.104.501
940.492.0240



2.
28410
621.997.0090



3.
28073
625.492.0040



4.
28450
305.492.0182
000.492.0082
357.492.0182



5.
00587
357.492.1240



Horizontal
LHD
Standard

Series O 407UE

Type

Euro II
03/87 → 11/01



Ueberland-
omnibus

WB 6150

OM 447 H
12,0l tr.
6 cyl.
177 KW/240 HP

OM 447 HLA
12,0l tr.
6 cyl.
220 KW/300 HP

►CHno069463

Baumuster

357.100
357.110
357.120
357.130

Front pipe

27766
357.490.1319

28679
620.490.0365

28674
620.492.0008
617.492.0008

27765
357.490.1419

28679
620.490.0365

28674
620.492.0008
617.492.0008

Silencer

28524
357.490.0301
357.490.1801

Tail pipe

28649
357.492.1204

Mounting Parts

1.
00992
071.555.075.502

2.
00901
071.555.094.502

3.
28478
620.997.0490

4.
00942
674.490.2819
303.493.0643
071.555.085.502

5.
28085
302.490.0080
442.492.0080

6.
28450
305.492.0182
000.492.0082
357.492.0182

7.
28089
322.504.0212

Horizontal
LHD
Standard

Series O 407UE

Type

Euro II
03/87 → 11/01



Überland-
omnibus

WB 6150

OM 447 H
12,0l tr.
6c yl.
177 KW/240 HP

Baumuster

357.100
357.110

Front pipe

Silencer

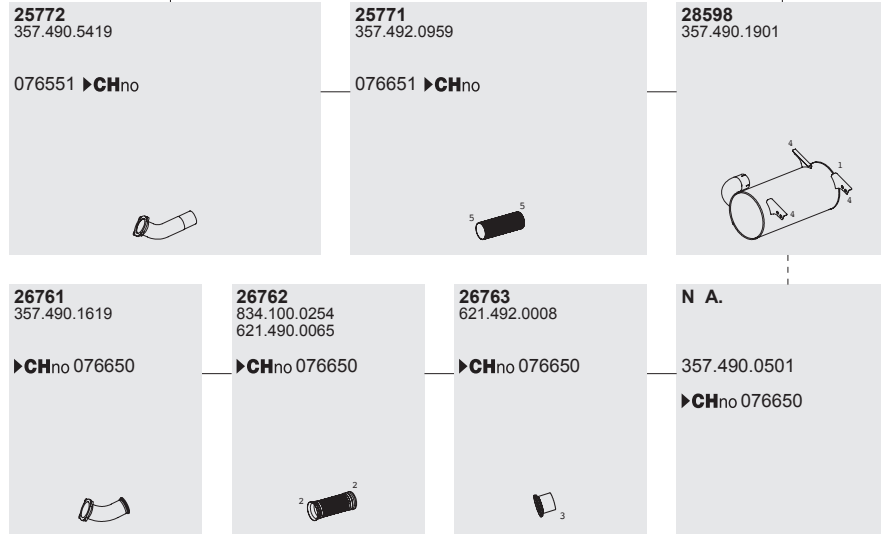

Mounting Parts

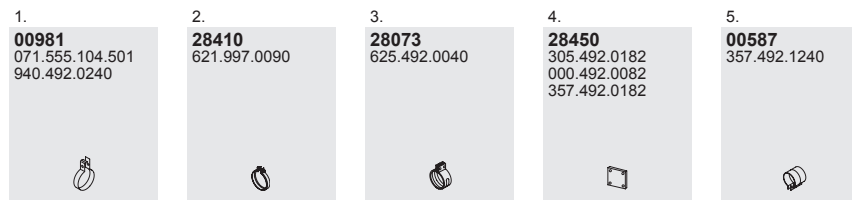

Horizontal
LHD
Standard

Series O 408

Type

Euro II
01/91 → 12/98



Überland-
omnibus

WB 6150

OM447 H
12,0l tr.
6 cyl.
177 KW/240 HP
184 KW/250 HP

►CHno069463

Baumuster

357.150
357.160

Front pipe

27766
357.490.1319



28679
620.490.0365



28674
620.492.0008
617.492.0008



28524
357.490.0301
357.490.1801

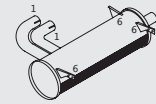

28949
357.492.1204



27765
357.490.1419



28679
620.490.0365



28674
620.492.0008
617.492.0008



Mounting Parts

1.
00992
071.555.075.502



2.
00901
071.555.094.502



3.
28478
620.997.0490



4.
00942
674.490.2819
303.493.0643
071.555.085.502



5.
28085
302.490.0080
442.492.0080



6.
28450
305.492.0182
000.492.0082
357.492.0182



7.
28089
322.504.0212



Horizontal
LHD
Standard

Series O 814

Type

Euro I



O 814

WB 3700, 4250

OM 366

6,0l tr.

6 cyl.

100 KW/136 HP

►CHno5.337.342

Baumuster

674.072

674.073

Front pipe

27718
674.490.2019

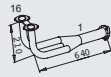

27717
674.490.1819



Silencer

28591
674.490.0201

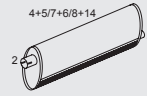

27388
674.492.1804

BM 674.072



Tail pipe

27386
673.492.1304

BM 674.072

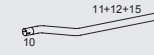

27385
674.492.2604

BM 674.073

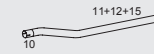

Mounting Parts

1.
00940
071.555.090.501
395.492.0040
645.492.1140



2.
28061
674.492.0040



3.
28063
673.492.0140
313.392.0340



4.
28429
674.491.0541



5. ►CHno 5.194.472
28424
674.490.0140



6.
28081
309.490.0037



7. 5.194.473 ►CHno
28420
674.490.2040



8.
28480
381.492.0082
301.492.0382
0201.175.00



9.
28466
617.492.2841
383.492.1341
617.492.1341



10.
00994
071.555.078.502



11.
00992
071.555.075.502



12.
28078
384.987.7140
001.987.9640
001.987.5340



13.
28439
617.491.1316



14. 5.194.473 ►CHno 5.337.342
28439
617.491.1316



15.
28017
620.524.0340



16.
28070



Horizontal
LHD
Standard

Series O 814

Type

Euro I



O 814

WB 3700, 4250



6,0l tr.
6 cyl.
100 KW/136 HP

5.337.343 ▶CHno

Baumuster

674.072
674.073

Front pipe

27718
674.490.2019

▶CHno 5.541.030

26705
674.490.4219

5.541.031 ▶CHno

26764
674.490.2919

5.337.343 ▶CHno

26702
675.490.0519

5.541.031 ▶CHno

27608
674.490.0065

5.337.343 ▶CHno

Silencer

28591
674.490.0201

26318
674.492.5104

BM 674.072

26367
674.492.5404

BM 674.073

Tail pipe

26351
674.492.6404

BM 674.072

26366
674.492.6304

BM 674.073

Mounting Parts

1.
00940
071.555.090.501
395.492.0040
645.492.1140

2.
28061
674.492.0040

3.
28438
674.491.4541
674.491.2641

4.
28063
673.492.0140
313.392.0340

5.
28466
617.492.2841
383.492.1341
617.492.1341

6.
28480
381.492.0082
301.492.0382
0201.175.00

7.
28439
617.491.1316

8.
00994
071.555.078.502

9.
00992
071.555.075.502

10.
28078
384.987.7140
001.987.9640
001.987.5340

11.
28017
620.524.0340

12.
28070

Horizontal
LHD
Standard

Series O 814F

Type

Euro I



O 814 F

WB 3700, 4250

OM 366

6,0l tr.

6 cyl.

100 KW/136 HP

►CHno5.337.342

Baumuster

674.272

674.273

Front pipe

27718
674.490.2019

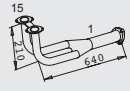

27717
674.490.1819

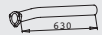

Silencer

28591
674.490.0201

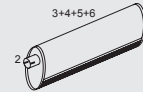

27388
674.492.1804

BM 674.272

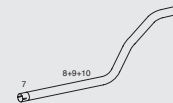

Tail pipe

26304
675.492.0304

BM 674.272



27387
674.492.2304

BM 674.273



Mounting Parts

1.
00940
071.555.090.501
395.492.0040
645.492.1140



2.
28061
674.492.0040



3.
28429
674.491.0541



4. ►CHno 5.194.472
28424
674.490.0140



4. 5.194.473 ►CHno 5.337.342
28420
674.490.2040



5. ►CHno 5.194.472
28081
309.490.0037



5. 5.194.473 ►CHno 5.337.342
28480
381.492.0082
301.492.0382
0201.175.00



6. 5.194.473 ►CHno 5.337.342
28439
617.491.1316



7.
28063
673.492.0140
313.392.0340



8.
28466
617.492.2841
383.492.1341
617.492.1341



9.
28480
381.492.0082
301.492.0382
0201.175.00



10.
28439
617.491.1316



11.
00994
071.555.078.502



12.
00992
071.555.075.502



13.
28017
620.524.0340



14.
28078
384.987.7140
001.987.9640
001.987.5340



15.
28070



Horizontal
LHD
Standard

Series O 814F

Type

Euro I



O 814 F

WB 3700, 4250

OM 366
6,0l tr.
6 cyl.
100 KW/136 HP

Baumuster

674.272
674.273

Front pipe

27718
674.490.2019

►CHno 5.541.030

26705
674.490.4219

5.541.031 ►CHno

26764
674.490.2919

5.337.343 ►CHno

26702
675.490.0519

5.541.031 ►CHno

27608
674.490.0065

5.337.343 ►CHno

Silencer

28591
674.490.0201

26318
674.492.5104

BM 674.272

26367
674.492.5404

BM 674.273

Tail pipe

26303
674.492.6204

BM 674.272

26309
674.492.6104

BM 674.273

Mounting Parts

1.
00940
071.555.090.501
395.492.0040
645.492.1140

2.
28061
674.492.0040

3.
28438
674.491.4541
674.491.2641

4.
28063
673.492.0140
313.392.0340

5.
28466
617.492.2841
383.492.1341
617.492.1341

6.
28480
381.492.0082
301.492.0382
0201.175.00

7.
28439
617.491.1316

8.
00994
071.555.078.502

9.
00992
071.555.075.502

10.
28078
384.987.7140
001.987.9640
001.987.5340

11.
28017
620.524.0340



12.
28070

Horizontal
LHD
Standard

Series O 817

Type
Euro I

Baumuster
676.063



④X②
O 817
WB 4250
 **OM 364 A**
4,0l tr.
4 cyl.
125 KW/170 HP
* ▶CHno
5.194.472
** 5.194.473
▶CHno 5.337.342
*** 5.337.343
▶CHno

Horizontal
LHD
Standard

Front pipe

26766
676.490.1119

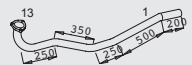
▶CHno 5.337.342



26765
676.490.1519

5.337.343 ▶CHno 5.528.482

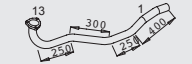

26761
676.490.5519
677.490.0819

5.528.483 ▶CHno

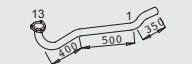

28420
674.490.2040



28480
381.492.0082
301.492.0382
0201.175.00



28438
674.491.4541
674.491.2641



28069
676.492.0040



28078
384.987.7140
001.987.9640
001.987.5340



00901
071.555.094.502



28017
620.524.0340



28075
0201.178.00
350.492.0080
0201.141.00



00992
071.555.075.502



Mounting Parts

1.
00940
071.555.090.501
395.492.0040
645.492.1140



2.
28061
674.492.0040



3.
28429
674.491.0541



Silencer

28559
676.490.0201



27900
676.492.0804

▶CHno 5.337.342

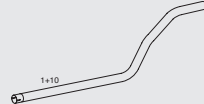

N.A.
674.492.2104

▶CHno 5.337.342

26378
676.492.4804

5.337.343 ▶CHno



Front pipe

27608
674.490.0065

5.337.343 ▶CHno



Silencer

Tail pipe

N.A.
676.492.1404

▶CHno 5.337.342

26377
676.492.5604

5.337.343 ▶CHno

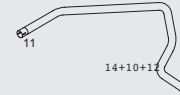

4.
28424
674.490.0140



5.
28081
309.490.0037



Series O 817L

Type

Euro I



O 817 L

WB 4250

OM 366 A
4,0l tr.
4 cyl.
125 KW/170 HP



* ▶CHno
5.194.472

** 5.194.473
▶CHno 5.337.342

*** 5.337.343
▶CHno

Baumuster

676.263

Front pipe

26766
676.490.1119

▶CHno 5.337.342

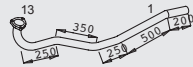

26765
676.490.1519

5.337.343 ▶CHno 5.528.482

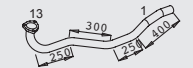

26761
676.490.5519
677.490.0819

5.528.483 ▶CHno

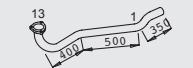

Silencer

27608
674.490.0065

5.337.343 ▶CHno



28559
676.490.0201

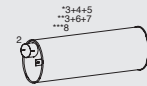

27900
676.492.0804

▶CHno 5.337.342

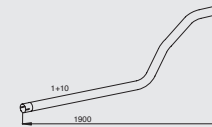

26387
676.492.3704

5.337.343 ▶CHno

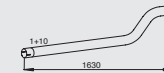

Tail pipe

26384
676.492.1104

▶CHno 5.337.342



26375
676.492.5004

5.337.343 ▶CHno



Mounting Parts

1.

00940
071.555.090.501
395.492.0040
645.492.1140



2.

28061
674.492.0040



3.

28429
674.491.0541



4.

28424
674.490.0140



5.

28081
309.490.0037



6.

28420
674.490.2040



7.

28480
381.492.0082
301.492.0382
0201.175.00



8.

28438
674.491.4541
674.491.2641



9.

28069
676.492.0040



10.

28078
384.987.7140
001.987.9640
001.987.5340



11.

00901
071.555.094.502



12.

28017
620.524.0340



13.

28075
0201.178.00
350.492.0080
0201.141.00



14.

00992
071.555.075.502



Horizontal
LHD
Standard

Series O 817L

Type

Euro I



O 817 L

WB 3250

OM 366 LA
6,0l tr.
6 cyl.
125 KW/170 HP

5.337.343 ▶CHno

Baumuster

676.264

Front pipe

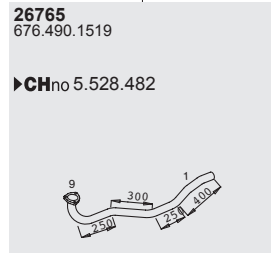

Silencer

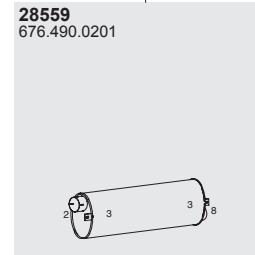

Tail pipe

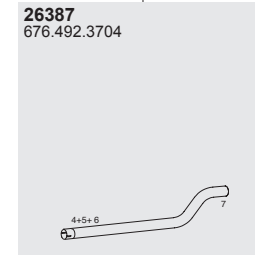

Mounting Parts

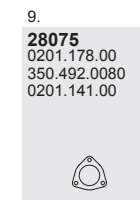
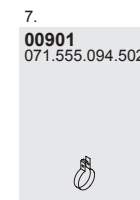
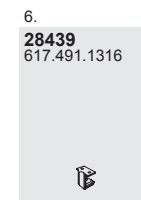
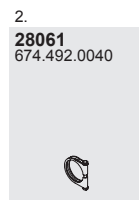
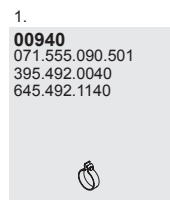

Horizontal
LHD
Standard

Series O 1114

Type



O1 114

WB 4250, 4900

OM 366

6,0l tr.

6 cyl.

100 KW/136 HP

* ▶CHno

5.194.472

** 5.194.473

▶CHno 5.337.342

*** 5.337.343

▶CHno

Baumuster

675.073

675.074

Front pipe

26705
674.490.4219

5.541.031 ▶CHno

27717
674.490.1819

▶CHno 5.337.342

27718
674.490.2019

▶CHno 5.541.030

26702
675.490.0519

Mounting Parts

1.

00940
071.555.090.501
395.492.0040
645.492.1140

26764
674.490.2919

5.337.343 ▶CHno
5.541.030

2.

28061
674.492.0040

3A.

28429
674.491.0541

3B.

28438
674.491.4541
674.491.2641

4A.

28424
674.490.0140

4B.

28420
674.490.2040

5A.

28081
309.490.0037

5B.

28480
381.492.0082
301.492.0382
0201.175.00

6.

28063
673.492.0140
313.392.0340

7.

28466
617.492.2841
383.492.1341
617.492.1341

Silencer

28591
674.490.0201

*3A+4A+5A
**3A+4B+5B
***3B

27387
674.492.2304

26365
674.492.2404

BM 675.074
▶CHno 5.337.342

26367
674.492.5404

BM 675.073
5.337.343 ▶CHno

Tail pipe

27385
674.492.2604

BM 675.073
▶CHno 5.337.342

26364
674.492.6604

BM 675.074
5.337.343 ▶CHno

26366
674.492.6304

BM 675.073
5.337.343 ▶CHno

10.

28070

9.

00994
071.555.078.502

8.

28439
617.491.1316

Horizontal
LHD
Standard

Series O 1114L

Type



O1 114 L/ 42
WB 4250

O1 114 L/ 49
WB 4900

OM 366
6l tr.
6 cyl.
100 KW/136 HP

* ▶CHno
5.194.472

** 5.194.473
▶CHno 5.337.342

*** 5.337.343
▶CHno

Baumuster

675.273
675.274

Front pipe

26705
674.490.4219

5.541.031 ▶CHno

27718
674.490.2019

▶CHno 5.541.030

27717
674.490.1819

▶CHno 5.337.342

26794
674.490.2919

5.337.343 ▶CHno
5.541.030

Silencer

28591
674.490.0201

* 3A+4A+5A
** 3A+4B+5B
*** 3B

27387
674.492.2304

BM 492.273
▶CHno 5.337.342

26367
674.492.5404

BM 675.273
5.337.343 ▶CHno

26365
674.492.2404

BM 675.274
▶CHno 5.337.342

Tail pipe

N.A.

675.492.0404
BM 675.273

26364
674.492.6604

BM 675.274
5.337.343 ▶CHno

Mounting Parts

1.
00940
071.555.090.501
395.492.0040
645.492.1140

2.
28061
674.492.0040

3A.
28429
674.491.0541

3B.
28438
674.491.4541
674.491.2641

4A.
28424
674.490.0140

4B.
28420
674.490.2040

5A.
28081
309.490.0037

5B.
28480
381.492.0082
301.492.0382
0201.175.00

6.
28063
673.492.0140
313.392.0340

7.
28466
617.492.2841
383.492.1341
617.492.1341

8.
28439
617.491.1316

9.
00994
071.555.078.502

10.
28070

Horizontal
LHD
Standard

Series O 1117

Type



O1 117

WB 4900

OM 366 A
6,0l tr.
6 cyl.
125 KW/170 HP

Baumuster

676.074

Front pipe

26765
676.490.1519

5.337.343 ▶CHno
5.528.482

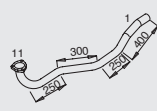

26761
676.490.5519
677.490.0819

5.528.483 ▶CHno

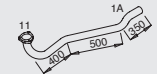

27608
674.490.0065

5.337.343 ▶CHno



Silencer

28559
676.490.0201

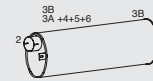

26376
676.492.3804
675.492.0004

5.337.343 ▶CHno

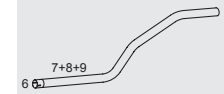

Tail pipe

N.A.

676.492.4904

Mounting Parts

1. ▶CHno 5.528.482

00940
071.555.090.501
395.492.0040
645.492.1140



1A. 5.528.483 ▶CHno

28069
676.492.0040



2.

28061
674.492.0040



3A. ▶CHno 5.337.342

28429
674.491.0541



3B. 5.337.343 ▶CHno

28438
674.491.4541
674.491.2641



4.

28081
309.490.0037



4A. 5.194.473 ▶CHno 5.337.342

28480
381.492.0082
301.492.0382
0201.175.00



5. ▶CHno 5.194.472

28439
617.491.1316



6.

28069
676.492.0040



7.

28016
616.492.2841



8.

28480
381.492.0082
301.492.0382
0201.175.00



9.

28439
617.491.1316



10.

00901
071.555.094.502



11.

28075
0201.178.00
350.492.0080
0201.141.00



Horizontal
LHD
Standard

Series O 1117L

Type



O1 117L

WB 3250

OM 366 LA
6,0l tr.
6 cyl.
125 KW/170 HP
5.337.343 ▶CHno

Baumuster

676.276

Front pipe

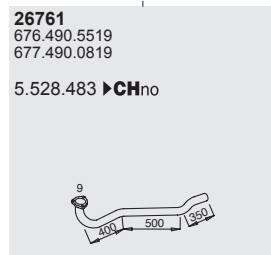
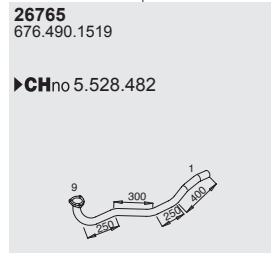

Silencer

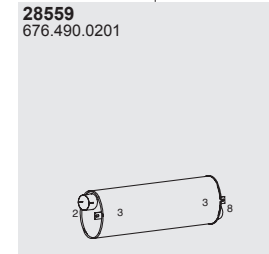

Mounting Parts

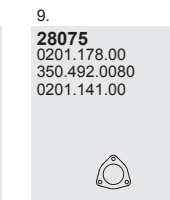
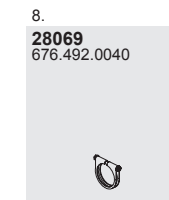
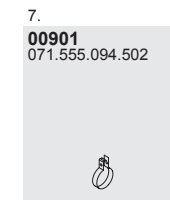
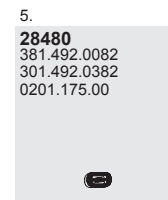
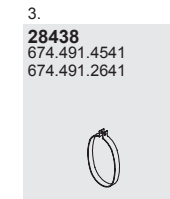
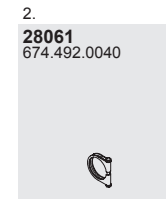

Tail pipe

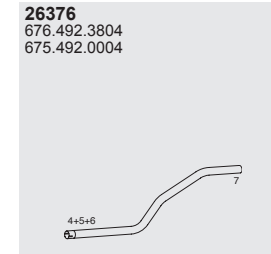
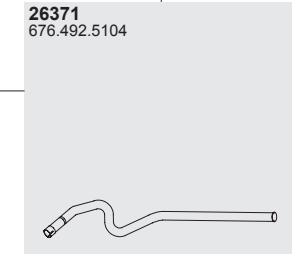

Horizontal
LHD
Standard

Series O 1117L

Type

Euro I



O1 117L

WB 4250

OM 366 A
6,0l tr.
6 cyl.
125 KW/170 HP



* ▶CHno
5.194.472

** 5.194.473
▶CHno 5.337.342

*** 5.337.343
▶CHno

Baumuster

676.273

Front pipe

26766
676.490.1119

▶CHno 5.337.342

26765
676.490.1519

5.337.343 ▶CHno 5.528.482

26761
676.490.5519
677.490.0819

5.528.483 ▶CHno

Silencer

27608
674.490.0065

5.337.343 ▶CHno

28559
676.490.0201

27900
676.492.0804

▶CHno 5.337.342

26387
676.492.3704

5.337.343 ▶CHno

Tail pipe

26383
676.492.1104

▶CHno 5.337.342

26375
676.492.5004

5.337.343 ▶CHno

Mounting Parts

1.
00940
071.555.090.501
395.492.0040
645.492.1140

2.
28061
674.492.0040

3.
28429
674.491.0541

4.
28424
674.490.0140

5.
28081
309.490.0037

6.
28420
674.490.2040

7.
28480
381.492.0082
301.492.0382
0201.175.00

8.
28438
674.491.4541
674.491.2641

9.
28069
676.492.0040

10.
28078
384.987.7140
001.987.9640
001.987.5340

11.
00901
071.555.094.502

12.
28017
620.524.0340

13.
28075
0201.178.00
350.492.0080
0201.141.00

14.
00992
071.555.075.502

Horizontal
LHD
Standard

Series O 1117L

Type **Baumuster**

Euro I 676.274



4X2

O1 117L

WB 4900

OM 366 A
6,0l tr.
6 cyl.
125 KW/170 HP

Front pipe

26766
676.490.1119

►CHno 5.337.342

26765
676.490.1519

5.337.343 ►CHno 5.528.482

26761
676.490.5519
677.490.0819

5.528.483 ►CHno

Silencer

27608
674.490.0065

5.337.343 ►CHno

28559
676.490.0201

26376
676.492.3804
675.492.0004

5.337.343 ►CHno

26371
676.492.5104

5.337.343 ►CHno

Tail pipe

Mounting Parts

1. ►CHno 5.528.482
00940
071.555.090.501
395.492.0040
645.492.1140

1A. 5.528.483 ►CHno
28069
676.492.0040

2. **28061**
674.492.0040

3A. ►CHno 5.337.342
28429
674.491.0541

3B. 5.337.343 ►CHno
28438
674.491.4541
674.491.2641

4. **28081**
309.490.0037

4A. 5.194.473 ►CHno 5.337.342
28480
381.492.0082
301.492.0382
0201.175.00

5. ►CHno 5.194.472
28439
617.491.1316

6. **28069**
676.492.0040

7. **28016**
616.492.2841

8. **28480**
381.492.0082
301.492.0382
0201.175.00

9. **28439**
617.491.1316

10. **00901**
071.555.094.502

11. **00992**
071.555.075.502

12. **28078**
384.987.7140
001.987.9640
001.987.5340

13. **28017**
620.524.0340

14. **28075**
0201.178.00
350.492.0080
0201.141.00

Horizontal
LHD
Standard

Series O 1120

Type

Euro I



O1 120

WB 4250

OM 366 LA
6,0l tr.
6 cyl.
150 KW/204 HP

►CHno5.337.342

Baumuster

677.073

Front pipe

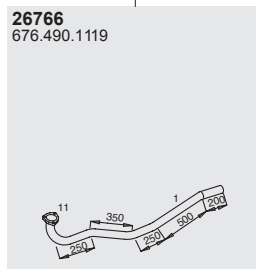

Silencer

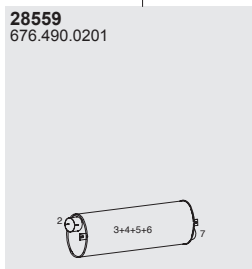

Tail pipe

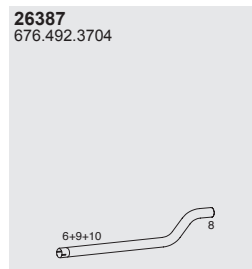

Mounting Parts

1.
00940
071.555.090.501
395.492.0040
645.492.1140

2.
28061
674.492.0040

3.
28429
674.491.0541

4. ►CHno 5.194.472
28424
674.490.0140

4. 5.194.473 ►CHno 5.337.342
28420
674.490.2040

5. 5.194.473 ►CHno 5.337.342
28480
381.492.0082
301.492.0382
0201.175.00

5. ►CHno 5.194.472
28081
309.490.0037

6. 5.194.473 ►CHno 5.337.342
28439
617.491.1316

7.
28069
676.492.0040

8.
00901
071.555.094.502

9.
28016
616.492.2841

10.
28480
381.492.0082
301.492.0382
0201.175.00

11.
28075
0201.178.00
350.492.0080
0201.141.00

Horizontal
LHD
Standard

Series O 1120

Type Baumuster

Euro I 677.073



4X2

O1 120

WB 4250

OM 366 LA
6,0l tr.
6 cyl.
150 KW/204 HP

5.337.343 ▶CHno

Front pipe

Silencer

Tail pipe

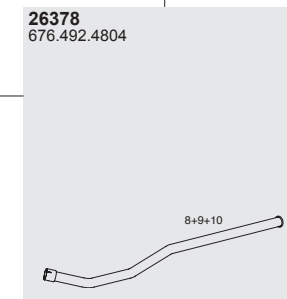
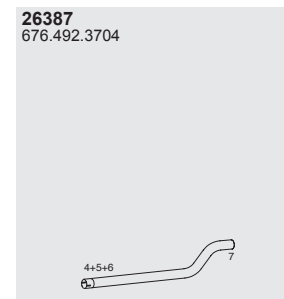
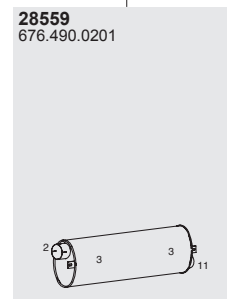
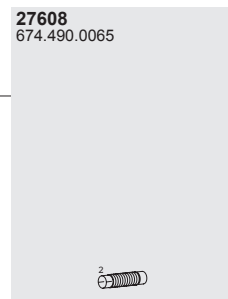
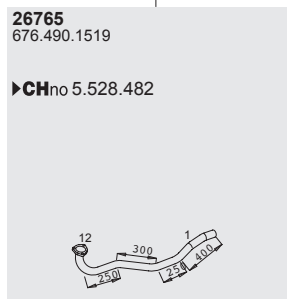

Mounting Parts

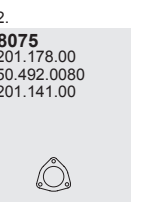
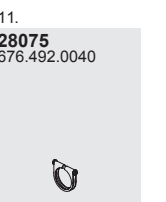
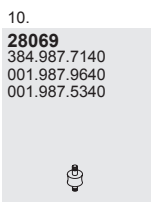
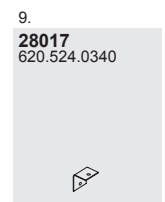
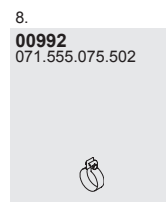
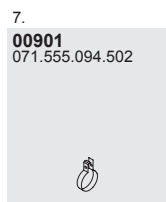
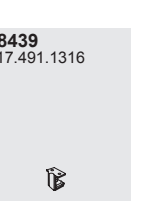
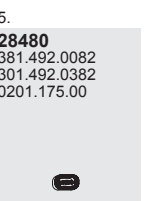
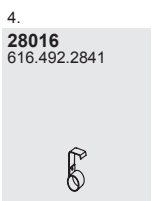
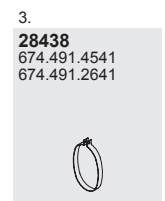
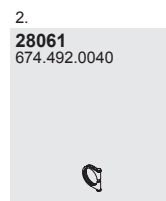
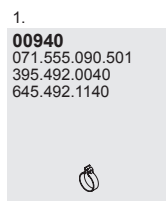

Horizontal
LHD
Standard

Series O 1120

Type

Euro I



O1 120

WB 4900

OM 366 LA
6,0l tr.
6 cyl.
150 KW/204 HP

▶CHno5.337.342

Baumuster

677.074

Front pipe

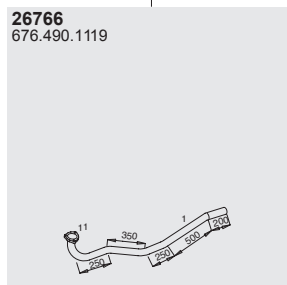

Silencer

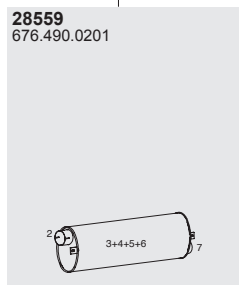

Tail pipe

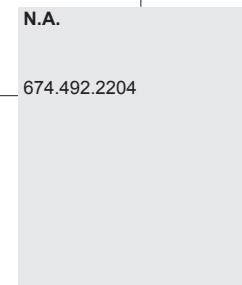
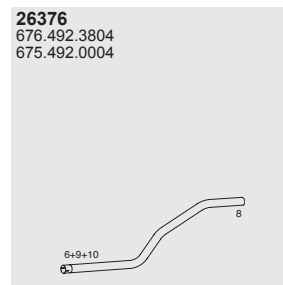

Mounting Parts

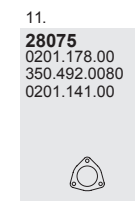
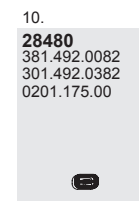
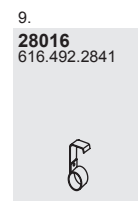
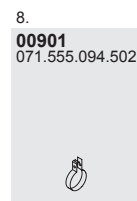
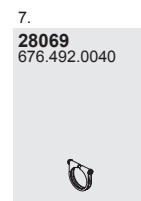
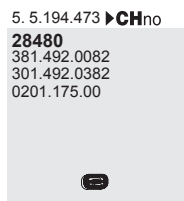
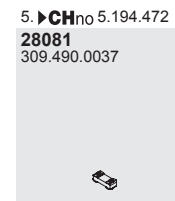
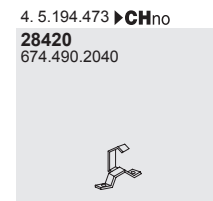
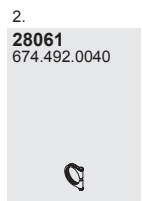
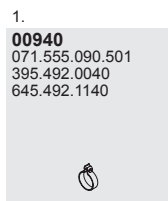

Horizontal
LHD
Standard

Series O 1120

Type **Baumuster**

Euro I 677.074



4X2

O1 120

WB 4900

OM 366 LA
6,0l tr.
6 cyl.
150 KW/204 HP

CHno 5.337.342

Front pipe

Silencer

Tail pipe

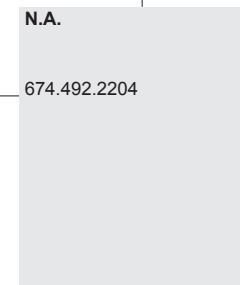
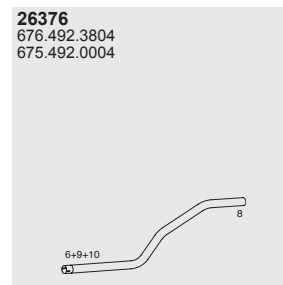
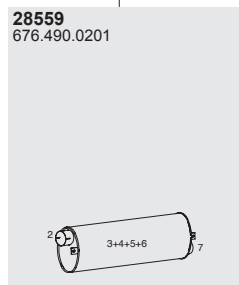
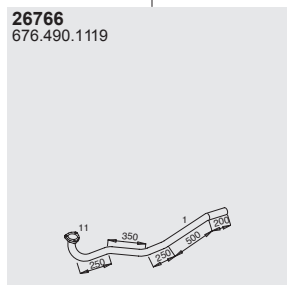

Mounting Parts

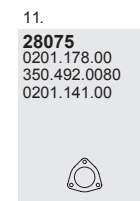
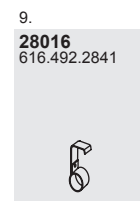
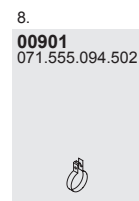
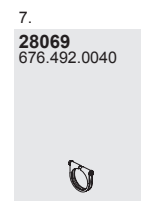
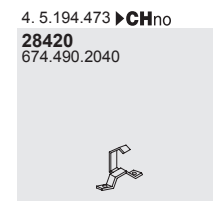
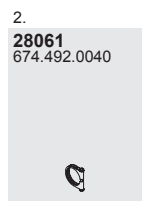
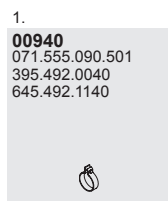

Horizontal
LHD
Standard

Series O 1120

Type Baumuster

Euro I 677.074



O1 120

WB 4900

OM 366 LA
6,0l tr.
6 cyl.
150 KW/204 HP

5.337.343 ▶CHno

Front pipe

Silencer

Tail pipe

26765
676.490.1119

27608
674.490.0065

28559
676.490.0201

26376
676.492.3804
675.492.0004

N.A.
676.492.4904

26371
676.490.1519

▶CHno 5.528.482

26761
676.490.5519
677.490.0819

5.528.483 ▶CHno

Mounting Parts

1.
00940
071.555.090.501
395.492.0040
645.492.1140

2.
28061
674.492.0040

3.
28438
674.491.4541
674.491.2641

4.
28016
616.492.2841

5.
28480
381.492.0082
301.492.0382
0201.175.00

6.
28439
617.491.1316

7.
00901
071.555.094.502

8.
28069
676.492.0040

9.
28075
0201.178.00
350.492.0080
0201.141.00

Horizontal
LHD
Standard

Series O 1120

Type Baumuster

Euro I 677.074



4X2

O1 120

WB 4900

OM 366 LA
6,0l tr.
6 cyl.
150 KW/204 HP

5.337.343 ▶CHno

Front pipe

Silencer

Tail pipe

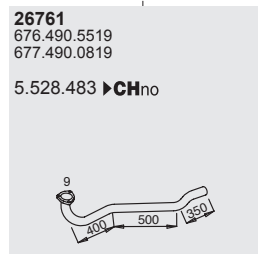
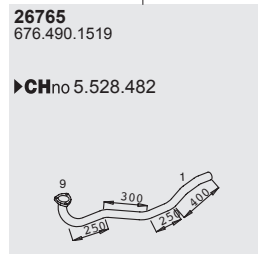
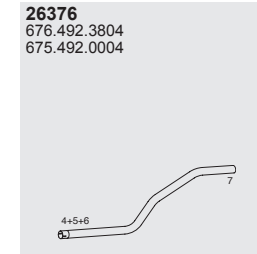
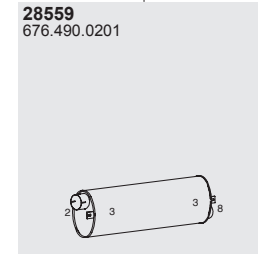
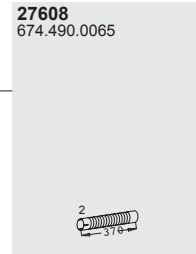
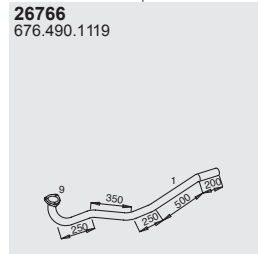

Mounting Parts

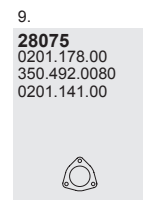
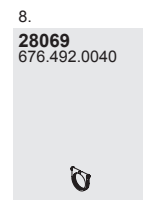
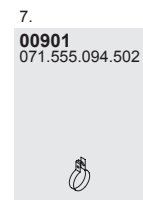
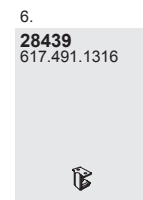
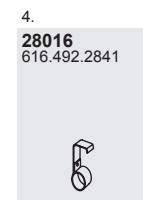
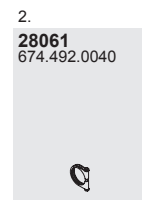
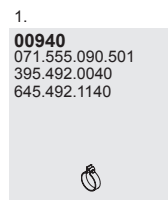

Horizontal
LHD
Standard

Series O 1120L

Type Baumuster

Euro I 677.273



4X2

O1 120 L

WB 4250

OM 366 LA
6,0l tr.
6 cyl.
150 KW/204 HP

5.337.343 ▶CHno

Front pipe

Silencer

Tail pipe

26765
676.490.1519

▶CHno 5.528.482

27608
674.490.0065

28559
676.490.0201

26387
676.492.3704

26375
676.492.5004

26761
676.490.5519
677.490.0819

5.528.483 ▶CHno

Mounting Parts

1.
00940
071.555.090.501
395.492.0040
645.492.1140

2.
28061
674.492.0040

3.
28438
674.491.4541
674.491.2641

4.
28016
616.492.2841

5.
28480
381.492.0082
301.492.0382
0201.175.00

6.
28439
617.491.1316

7.
00901
071.555.094.502

8.
28069
676.492.0040

9.
28075
0201.178.00
350.492.0080
0201.141.00

Horizontal
LHD
Standard

Series O 1120L

Type

Euro I



O1 120 L

WB 4900

OM 366 LA
6,0l tr.
6 cyl.
150 KW/204 HP

5.337.343 ▶CHno

Baumuster

677.274

Front pipe

26765
676.490.1519

▶CHno 5.528.482

26761
676.490.5519
677.490.0819

5.528.483 ▶CHno

Silencer

27608
674.490.0065

28559
676.490.0201

26376
676.492.3804
675.492.0004

Tail pipe

26371
676.492.5104

Mounting Parts

1.
00940
071.555.090.501
395.492.0040
645.492.1140

2.
28061
674.492.0040

3.
28438
674.491.4541
674.491.2641

4.
28016
616.492.2841

5.
28480
381.492.0082
301.492.0382
0201.175.00

6.
28439
617.491.1316

7.
00901
071.555.094.502

8.
28069
676.492.0040

9.
28075
0201.178.00
350.492.0080
0201.141.00

Horizontal
LHD
Standard

Series OH 1622

Type

Euro I



OH 1622

WB 5700, 6300

OM 421

11,0 ltr.

6 cyl.

159 KW/216 HP

►CHno5.394.166

Baumuster

396.356

396.358

Front pipe

N.A.

396.490.0319
Right Hand Side

27735

396.490.0219

LeftH and Side



28679
620.490.0365



28679
620.490.0365



28674
620.492.0008
617.492.0008



28674
620.492.0008
617.492.0008



N.A.

396.490.0125
Right Hand Side

N.A.

396.490.0325
LeftH and Side

Silencer

28522
620.490.0001

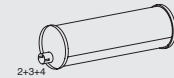

28522
620.490.0001

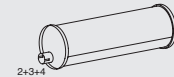

Tail pipe

28384
360.492.1907

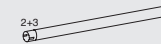

28384
360.492.1907

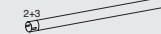

Mounting Parts

1.

28478
620.997.0490



2.

28084
300.492.0082



3.

28439
617.491.1316



4.

00992
071.555.075.502



5.

28468
620.492.0840
620.490.0840



6.

28085
302.490.0080
442.492.0080



Horizontal
LHD
Standard

Series OH 1622

Type

Euro I



OH 1622

WB 5700, 6300

OM 421

11,0 ltr.

6 cyl.

156 KW/216 HP

5.394.167 ▶CHno

Baumuster

396.356

396.358

Front pipe

26648
396.490.0519

Right Hand Side

28679
620.490.0365

28674
620.492.0008
617.492.0008

26690
396.490.0809

Right Hand Side

28522
620.490.0001

28384
360.492.1907

26647
396.490.0819

LeftH and Side

28679
620.490.0365

28674
620.492.0008
617.492.0008

26649
396.490.1225

LeftH and Side

28522
620.490.0001

28384
360.492.1907

Mounting Parts

1.
28478
620.997.0490

2.
28084
300.492.0082

3.
28439
617.491.1316

4.
00992
071.555.075.502

5.
28469
620.492.0840
620.490.0840

6.
28085
302.490.0080
442.492.0080

Horizontal
LHD
Standard

Series OH 1622L

Type

Euro I



OH 1622 L

WB 5700, 6300

OM 421

11,0 ltr.

6 cyl.

156 KW/216 HP

►CHno5.394.166

Baumuster

396.456

396.458

Front pipe

N.A.

396.490.0319
Right HandS ide

27735

396.490.0219

LeftH andS ide



28679

620.490.0365



28674

620.492.0008
617.492.0008



N.A.

396.490.0125
Right HandS ide

N.A.

396.490.0325
LeftH andS ide

Silencer

28522

620.490.0001

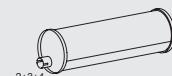

28522

620.490.0001

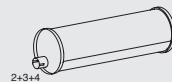

Tail pipe

28384

360.492.1907

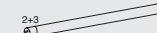

28384

360.492.1907

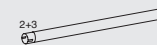

Mounting Parts

1.

28478

620.997.0490



2.

28084

300.492.0082



3.

28439

617.491.1316



4.

00992

071.555.075.502



5.

28469

620.492.0840
620.490.0840



6.

28085

302.490.0080
442.492.0080



Horizontal
LHD
Standard

Series OH 1622L

Type

Euro I



OH 1622 L

WB 5700, 6300

OM 421

11,0 ltr.

6 cyl.

159 KW/216 HP

5.394.167 ▶CHno

Baumuster

396.456

396.458

Front pipe

26647
396.490.0819

LeftH andS ide



28679
620.490.0365



28674
620.492.0008
617.492.0008



26646
396.490.1225

LeftH andS ide



28522
620.490.0001

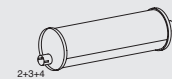

28384
360.492.1907

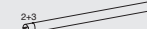

26648
396.490.0519

Right HandS ide



28679
620.490.0365



28674
620.492.0008
617.492.0008



26690
396.490.0809

Right HandS ide



28522
620.490.0001

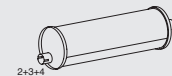

28384
360.492.1907

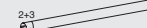

Silencer

Tail pipe

Mounting Parts

1.
28478
620.997.0490



2.
28084
300.492.0082



3.
28439
617.491.1316



4.
00992
071.555.075.502



5.
28469
620.492.0840
620.490.0840



6.
28085
302.490.0080
442.492.0080



Horizontal
LHD
Standard

Series OH 1625

Type

Euro I



OH 1625

WB 5700, 6300

OM 422

14,6l tr.

8 cyl.

184 KW/250 HP

Baumuster

396.376

396.378

Front pipe

27731
396.490.0019

LeftH and Side



28679
620.490.0365



28674
620.492.0008
617.492.0008



N.A.

396.490.0025
LeftH and Side

28522
620.490.0001

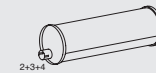

28384
360.492.1907

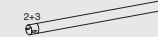

25378
624.492.0904



27733
396.490.0119

Right Hand Side
▶CHno 5.666.094



28679
620.490.0365



28674
620.492.0008
617.492.0008



N.A.

396.490.0125
Right Hand Side
▶CHno 5.666.094

28522
620.490.0001

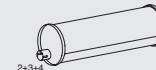

28384
360.492.1907

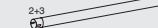

25378
624.492.0904



N.A.

396.492.0233
Right Hand Side
5.666.095 ▶CHno

26699
396.492.0909

Right Hand Side
5.666.095 ▶CHno



Mounting Parts

1.
28478
620.997.0490



2.
28084
300.492.0082



3.
28439
617.491.1316



4.
00992
071.555.075.502



5.
28469
620.492.0840
620.490.0840



6.
28085
302.490.0080
442.492.0080



Horizontal
LHD
Standard

Series OH 1625L

Type

Euro I



OH 1625 L

WB 5700, 6300

OM 422

14,6l tr.

8 cyl.

184 KW/250 HP

Baumuster

396.476

396.478

Front pipe

Silencer

Tail pipe

27731
396.490.0019

LeftH andS ide

28679
620.490.0365

28674
620.492.0008
617.492.0008

N.A.

396.490.0025
LeftH andS ide

28522
620.490.0001

28384
360.492.1907

25378
624.492.0904

27733
396.490.0119

Right HandS ide
▶CHno 5.666.094

28679
620.490.0365

28674
620.492.0008
617.492.0008

N.A.

396.490.0125
Right HandS ide
▶CHno 5.666.094

28522
620.490.0001

28384
360.492.1907

25378
624.492.0904

N.A.

396.492.0233
Right HandS ide
5.666.095 ▶CHno

26699
396.492.0909

Right HandS ide
5.666.095 ▶CHno

Mounting Parts

1.
28478
620.997.0490

2.
28084
300.492.0082

3.
28439
617.491.1316

4.
00992
071.555.075.502

5.
28469
620.492.0840
620.490.0840

6.
28085
302.490.0080
442.492.0080

Horizontal
LHD
Standard

Series OH 1627

Type

Euro I



OM 422
14,6l tr.
8 cyl.
195 KW/265 HP

Baumuster

396.473

396.483

Front pipe

27731
396.490.0019

LeftH and Side

28679
620.490.0365

28674
620.492.0008
617.492.0008

N.A.

396.490.0025
LeftH and Side

28522
620.490.0001

28384
360.492.1907

25378
624.492.0904

27733
396.490.0119

Right Hand Side
▶CHno 5.666.094

28679
620.490.0365

28674
620.492.0008
617.492.0008

N.A.

396.490.0125
Right Hand Side
▶CHno 5.666.094

28522
620.490.0001

28384
360.492.1907

25378
624.492.0904

N.A.

396.492.0233
Right Hand Side
5.666.095 ▶CHno

26699
396.492.0909

Right Hand Side
5.666.095 ▶CHno

Mounting Parts

1.
28478
620.997.0490

2.
28084
300.492.0082

3.
28439
617.491.1316

4.
00992
071.555.075.502

5.
28469
620.492.0840
620.490.0840

6.
28085
302.490.0080
442.492.0080

Horizontal
LHD
Standard

Series OH 1628

Type

Euro I



OH 1628

WB 5700, 6200

OM 422

14,6l tr.

8 cyl.

206 KW/280 HP

Baumuster











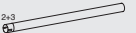

396.386

396.388





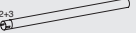

Front pipe

Silencer

Tail pipe

<p>27731 396.490.0019</p> <p>LeftH and Side</p> 	<p>28679 620.490.0365</p> 	<p>28674 620.492.0008 617.492.0008</p> 	<p>N.A.</p> <p>396.490.0025 LeftH and Side</p>	<p>28522 620.490.0001</p> 	<p>28384 360.492.1907</p> 	<p>25378 624.492.0904</p> 
<p>27733 396.490.0119</p> <p>Right Hand Side ▶CHno 5.666.094</p> 	<p>28679 620.490.0365</p> 	<p>28674 620.492.0008 617.492.0008</p> 	<p>N.A.</p> <p>396.490.0125 Right Hand Side ▶CHno 5.666.094</p>	<p>28522 620.490.0001</p> 	<p>28384 360.492.1907</p> 	<p>25378 624.492.0904</p> 
<p>N.A.</p> <p>396.492.0233 Right Hand Side 5.666.095 ▶CHno</p>			<p>26699 396.492.0909</p> <p>Right Hand Side 5.666.095 ▶CHno</p> 			

Mounting Parts

<p>1. 28478 620.997.0490</p> 	<p>2. 28084 300.492.0082</p> 	<p>3. 28439 617.491.1316</p> 	<p>4. 00992 071.555.075.502</p> 	<p>5. 28469 620.492.0840 620.490.0840</p> 	<p>6. 28085 302.490.0080 442.492.0080</p> 
---	---	--	--	--	--

Horizontal
LHD
Standard

Series OH 1628L

Type

Euro I



OH 1628 L

WB 5700, 6300

OM 422

14,6l tr.

8 cyl.

206 KW/265 HP

Baumuster

396.486

396.488

Front pipe

Silencer

Tail pipe

27731
396.490.0019

LeftH and Side

28679
620.490.0365

28674
620.492.0008
617.492.0008

N.A.

396.490.0025
LeftH and Side

28522
620.490.0001

28384
360.492.1907

25378
624.492.0904

27733
396.490.0119

Right Hand Side
▶CHno 5.666.094

28679
620.490.0365

28674
620.492.0008
617.492.0008

N.A.

396.490.0125
Right Hand Side
▶CHno 5.666.094

28522
620.490.0001

28384
360.492.1907

25378
624.492.0904

N.A.

396.492.0233
Right Hand Side
5.666.095 ▶CHno

26699
396.492.0909

Right Hand Side
5.666.095 ▶CHno

Mounting Parts

1.
28478
620.997.0490

2.
28084
300.492.0082

3.
28439
617.491.1316

4.
00992
071.555.075.502

5.
28469
620.492.0840
620.490.0840

6.
28085
302.490.0080
442.492.0080

Horizontal
LHD
Standard

Series **SPRINTER**

Type

Euro 2
02/95 → 04/00



OM 601
2,3l tr.
4 cyl.
58 KW/79H P

208 D
308 D
408 D

Baumuster

901.311
901.312
901.321
902.311
902.312
902.321
902.322
903.311
903.312
903.313
903.321
903.322
903.323
903.362
904.312
904.313
904.322
904.323

Silencer

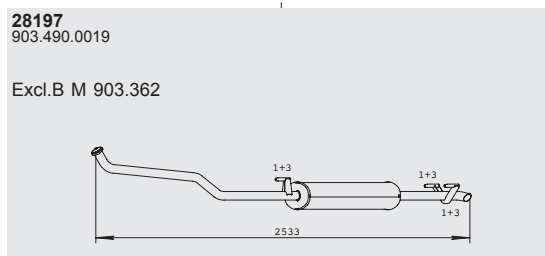
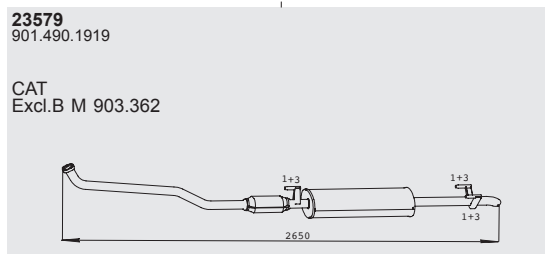
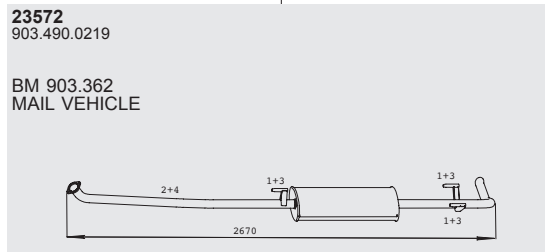

Mounting Parts

1.
28042
901.492.0044



2. Kit
18828



3.
23475
901.492.4141



4. CAT retrofit
18572



Horizontal
LHD/RHD
Standard

Series **SPRINTER**

Type

Euro 2
02/95 → 04/00



OM 601
2,3l tr.
4 cyl.
58 KW/79H P

208 D
308 D
408 D

Baumuster

901.311
901.312
901.321
901.361
901.362
901.371
902.311
902.312
902.321
902.322
902.361
902.362
902.371
902.372
903.311
903.312
903.313
903.321
903.322
903.323
903.361
903.362
903.363
903.371
903.372
903.373
904.312
904.313
904.322
904.323
904.362
904.363

Silencer

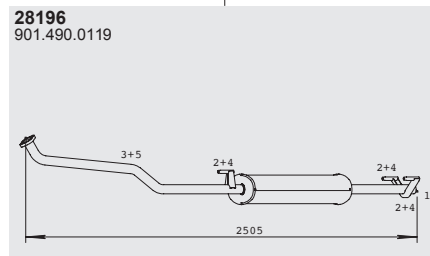
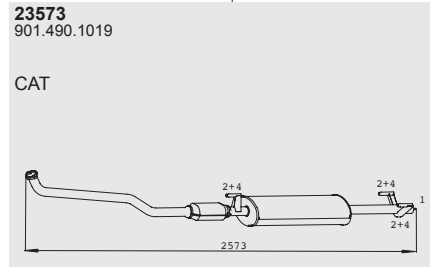

Mounting Parts

1.
00822
631.492.0240
608.492.0440
603.492.0740



2.
28042
901.492.0044



3. Kit
18828



4.
23475
901.492.4141



5. CAT retrofit
18572



Tail pipe

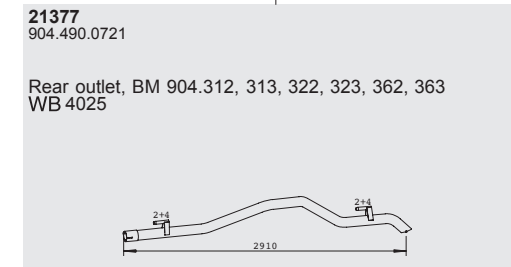
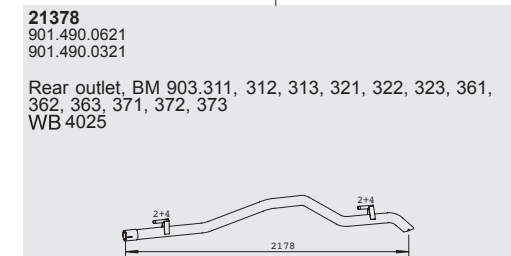
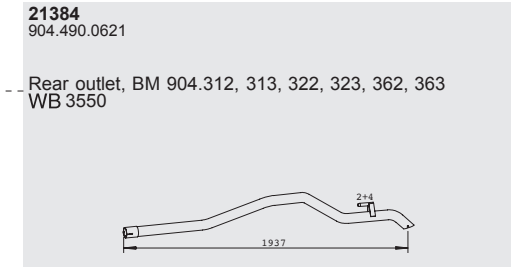
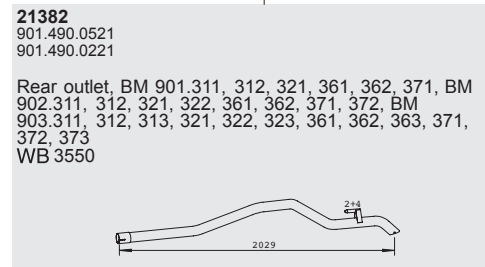
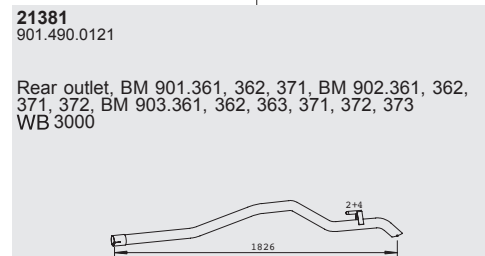
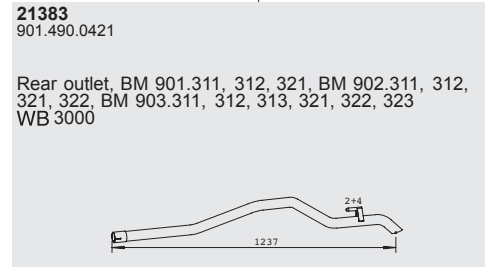

Horizontal
LHD
Standard

Series **SPRINTER**

Type

Euro 2
02/95 → 04/00



OM 601
2,3l tr.
4 cyl.
58 KW/79H P

208 D
308 D
408 D

Baumuster

- 901.311
- 901.312
- 901.321
- 901.361
- 901.362
- 901.371
- 902.311
- 902.312
- 902.321
- 902.322
- 902.361
- 902.362
- 902.371
- 902.372
- 903.311
- 903.312
- 903.313
- 903.321
- 903.322
- 903.323
- 903.361
- 903.362
- 903.363
- 903.371
- 903.372
- 903.373
- 904.312
- 904.313
- 904.322
- 904.323
- 904.362
- 904.363

Silencer

23573
901.490.1019

CAT

28196
901.490.0119

Mounting Parts

1.
00822
631.492.0240
608.492.0440
603.492.0740



2.
28042
901.492.0044



3. Kit
18828



4.
23475
901.492.4141



5. CAT retrofit
18572



Tail pipe

21385
901.490.2521
904.490.1421

Lefts ide outleti n front of rear axle, BM 901.311, 312, 321, 902.311, 312, 321, 322, 903.311, 312, 313, 321, 322, 323, WB 3550

21371
904.490.1421
901.490.2521

Lefts ide outleti n front of rear axle, BM 904.312, 313, 322, 323, WB 3550, 4025

21376
901.492.2704

BM 901.361, 362, 371, 902.361, 362, 371, 372, 903.361, 362, 363, 371, 372, 373, WB 3000, 3550, 4025

21375
901.490.2721

Lefts ide outleta ferr ear axle, WB 3000, 3550, 4025, BM 901.361, 362, 371, 902.361, 362, 371, 372, 903.361, 362, 363, 371, 372, 373

Horizontal
LHD
Standard

Series **SPRINTER**

Type

Euro 2
02/95 → 04/00



OM 601
2,3l tr.
4 cyl.
58 KW/79H P

208 D
308 D
408 D

Baumuster

901.311
901.312
901.321
901.361
901.362
901.371
902.311
902.312
902.321
902.322
902.361
902.362
902.371
902.372
903.311
903.312
903.313
903.321
903.322
903.323
903.361
903.362
903.363
903.371
903.372
903.373
904.312
904.313
904.322
904.323
904.362
904.363

Silencer

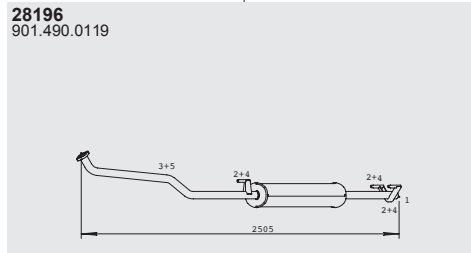
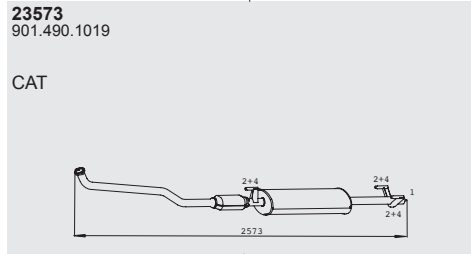

Tail pipe

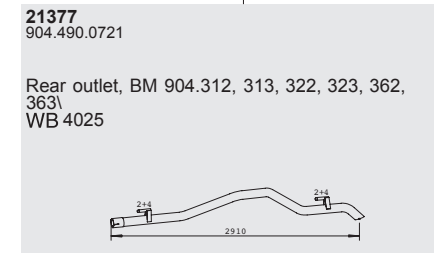
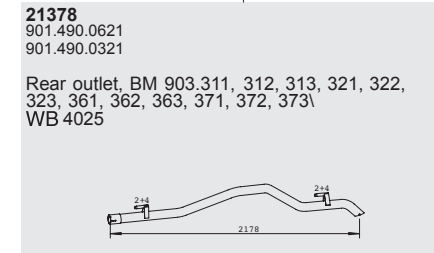
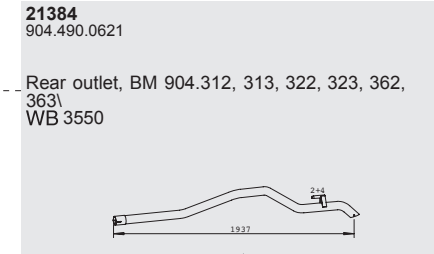
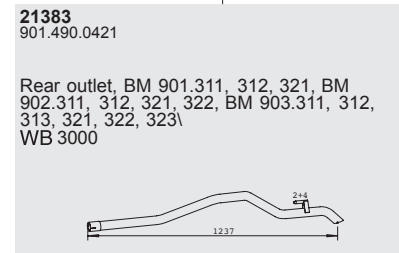
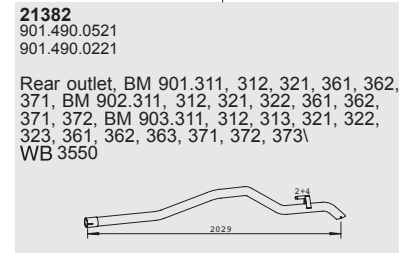
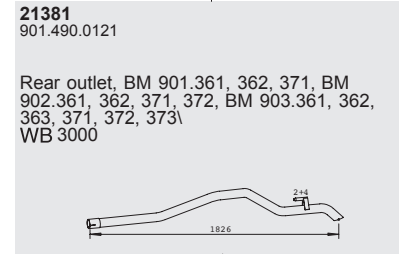

Mounting Parts

1.
00822
631.492.0240
608.492.0440
603.492.0740



2.
28042
901.492.0044



3. Kit
18828



4.
23475
901.492.4141



5. CAT retrofit
18572



Horizontal
RHD
Standard

Series **SPRINTER**

Type

Euro 2
02/95 → 04/00



OM 602
2,9l tr.
5 cyl.
75 KW/102 HP
90 KW/122 HP

210 D
212 D
310 D
312 D
410 D
412 D

Baumuster

901.421
902.411
902.412
902.421
902.422
903.411
903.412
903.413
903.421
903.422
903.423
904.412
904.413
904.422
904.423

Front pipe

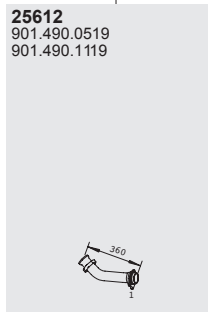

Silencer

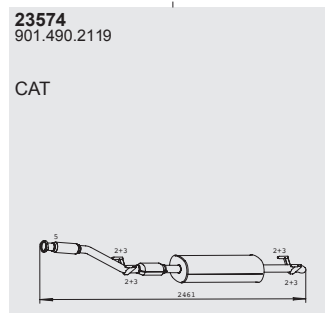
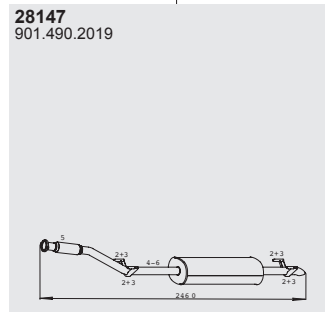

Mounting Parts

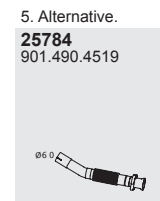
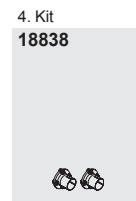
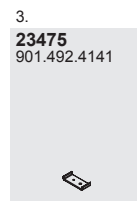
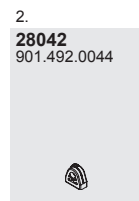
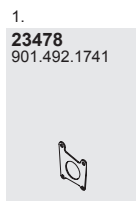

Horizontal
LHD/RHD
Standard

Series **SPRINTER**

Type

Euro 2
02/95 → 04/00



OM 602
2,9l tr.
5 cyl.
75 KW/102 HP
90 KW/122 HP

210 D
212 D
310 D
312 D
410 D
412 D

Baumuster

901.421
901.461
901.462
902.411
902.412
902.421
902.422
902.461
902.462
902.471
902.472
903.411
903.412
903.413
903.421
903.422
903.423
903.461
903.462
903.463
903.471
903.472
903.473
904.412
904.413
904.422
904.423
904.462
904.463

Front pipeT

25612
901.490.0519
901.490.1119

23570
901.490.2219

CAT

Silencer

28113
901.490.1319
901.490.1519
901.490.0719

18561
901.490.1219

CAT

23568
901.490.4019
901.490.2419

ail pipe

21387
904.490.1521

Lefts ide outleti n front of rear axle, BM 904.412, 413, 422, 423, WB 3550/4025

25987
901.492.2804

BM 901.461, 462, BM 902.461, 462, 471, 472, BM 903.461, 462, 463, 471, 472, 473, WB 3000/3550

21386
901.490.3121

►CHno P866648, BM 903.461, 462, 463, 471, 472, 473, WB 4025

21388
901.490.2621

Lefts ide outleti n front of rear axle, BM 902.411, 412, 421, 422, BM 903.411, 412, 413, 421, 422, 423

23278
901.490.3321

Lefts ide outleta fterr ear axle, BM 901.461, 462, 902.461, 462, 471, 472, 903.461-463, 471-473

23275
901.490.5021

P866649 ►CHno ,R 000001 ►CHno ,B M 903.461, 462, 463, 471, 472, 473, WB 4025

Mounting Parts

1.
23478
901.492.1741

2.
28042
901.492.0044

3.
23475
901.492.4141

4.
23477
901.492.6741

5.
00831
124.490.0141
901.490.0041
639.490.0041

6. Kit
18838



7. Alternative.
25784
901.490.4519

8. CAT retrofit
18572

Horizontal
LHD
Standard

Series **SPRINTER**

Type

Euro 2/3
02/95 → 05/06

WB 4025

2,3l tr.
4 cyl.
105 KW/143 HP

214
314
414

Baumuster

901.061 904.663
901.062
901.661
901.662
902.011
902.012
902.061
902.062
902.071
902.072
902.611
902.612
902.661
902.662
902.671
902.672
903.011
903.012
903.013
903.022
903.061
903.062
903.063
903.071
903.072
903.073
903.611
903.612
903.613
903.622
903.661
903.662
903.663
903.671
903.672
903.673
904.012
904.013
904.062
904.063
904.612
904.613
904.662

Horizontal
LHD/RHD
Standard

Front pipe

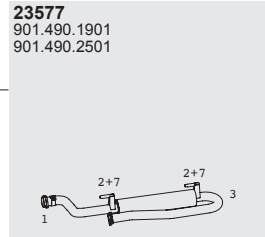
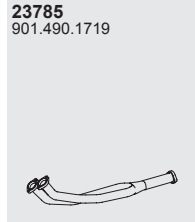

Silencer

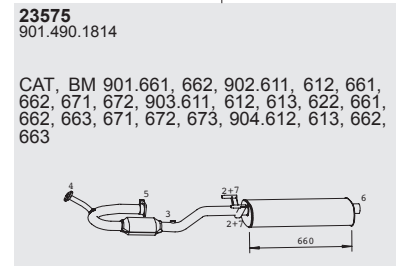
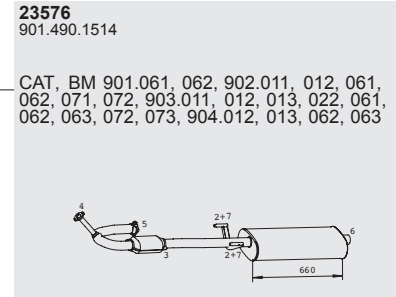
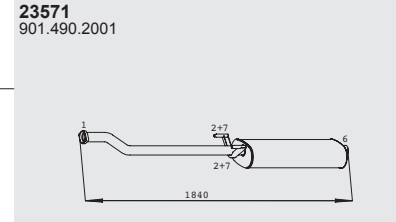

Tail pipe

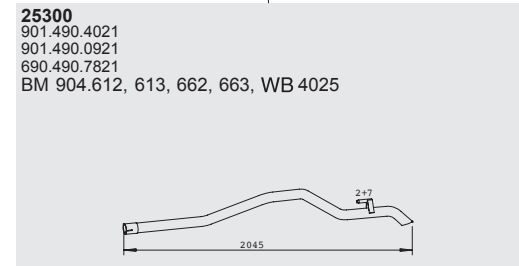
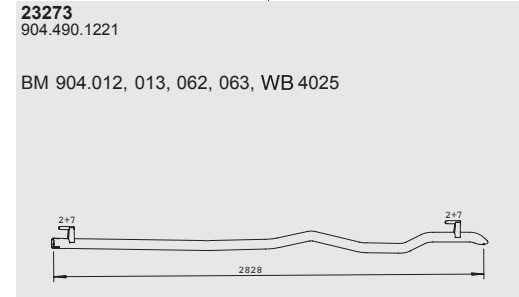
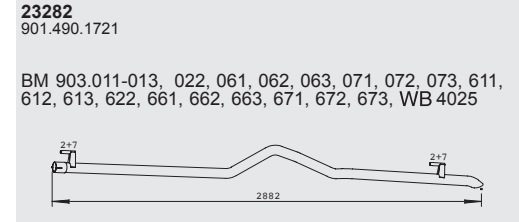

Mounting Parts

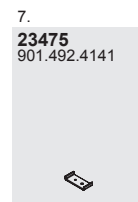
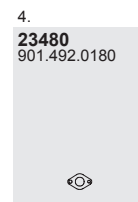
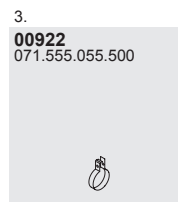
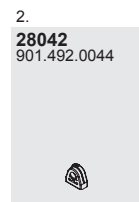
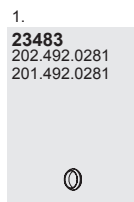

Series **SPRINTER**

Type

Euro 3
02/95 → 05/06



M111
2,3l tr.
4 cyl.
105 KW/143 HP

214
314
414

Baumuster

901.061 904.663
901.062
901.661
901.662
902.011
902.012
902.061
902.062
902.071
902.072
902.611
902.612
902.661
902.662
902.671
902.672
903.011
903.012
903.013
903.022
903.061
903.062
903.063
903.071
903.072
903.073
903.611
903.612
903.613
903.622
903.661
903.662
903.663
903.671
903.672
903.673
904.012
904.013
904.062
904.063
904.612
904.613
904.662

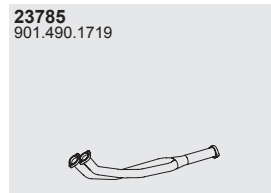
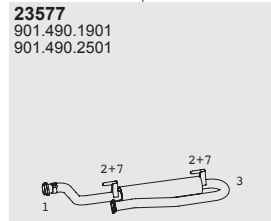
Front pipe



Mounting Parts

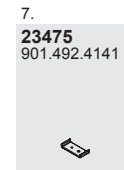
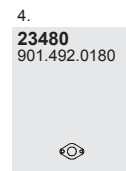
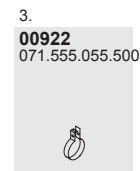

Silencer

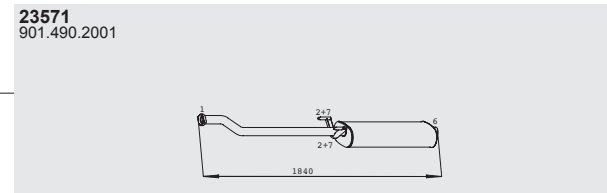
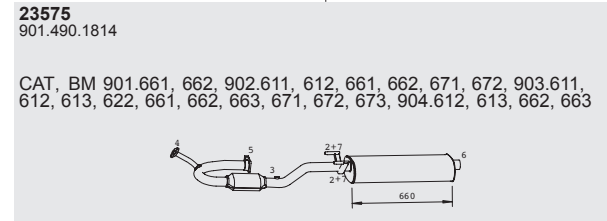
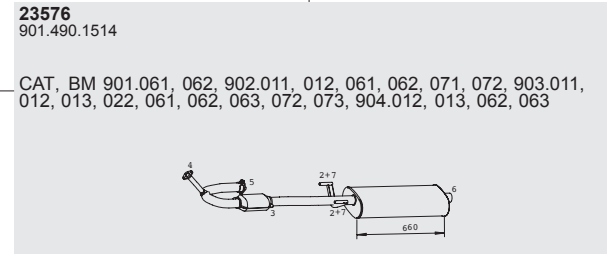

Tail pipe

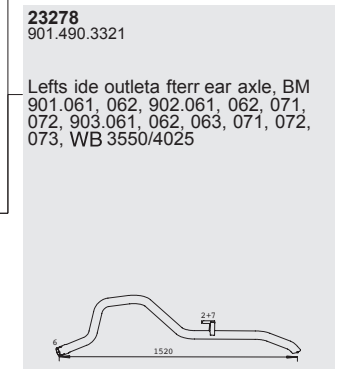
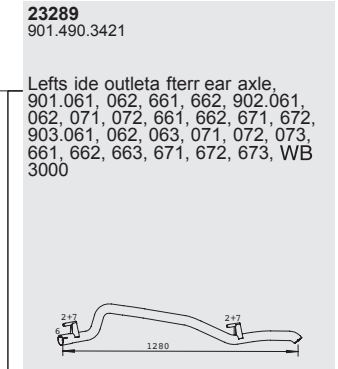
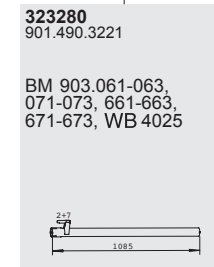
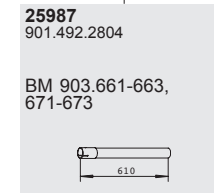
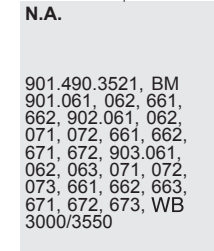
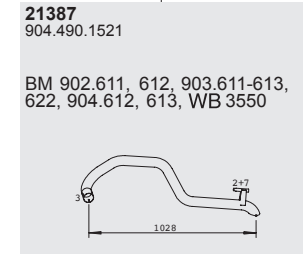

Horizontal
LHD/RHD
Standard

Series **SPRINTER**

Type

Euro 2/3
02/95 → 05/06

WB 3000, 3550

2,3l tr.
4 cyl.
105 KW/143 HP

214
314
414

Baumuster

901.061 904.663
901.062
901.661
901.662
902.011
902.012
902.061
902.062
902.071
902.072
902.611
902.612
902.661
902.662
902.671
902.672
903.011
903.012
903.013
903.022
903.061
903.062
903.063
903.071
903.072
903.073
903.611
903.612
903.613
903.622
903.661
903.662
903.663
903.671
903.672
903.673
904.012
904.013
904.062
904.063
904.612
904.613
904.662

Front pipe

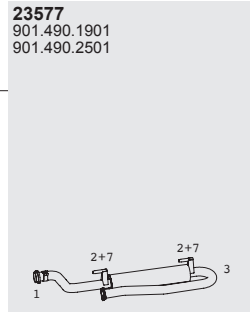
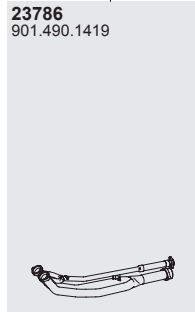
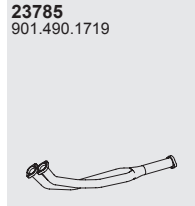

Mounting Parts

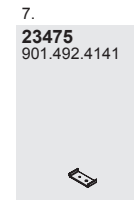
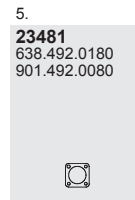
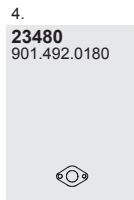
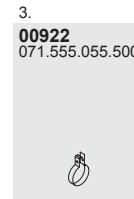
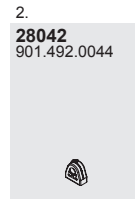
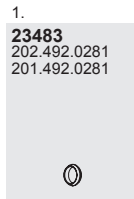

Silencer

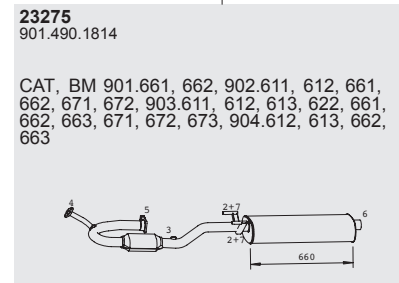
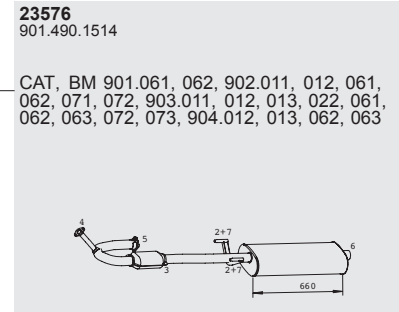
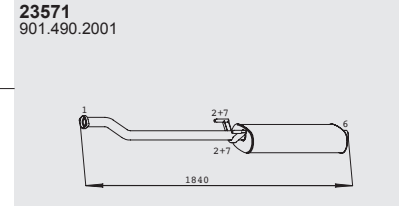

Tail pipe

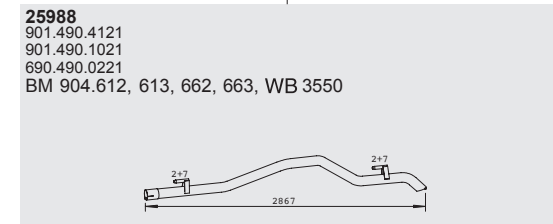
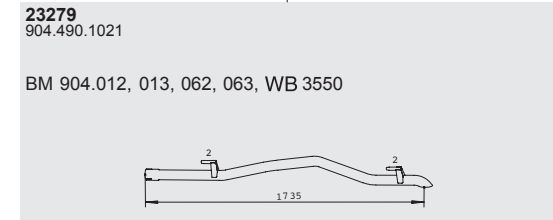
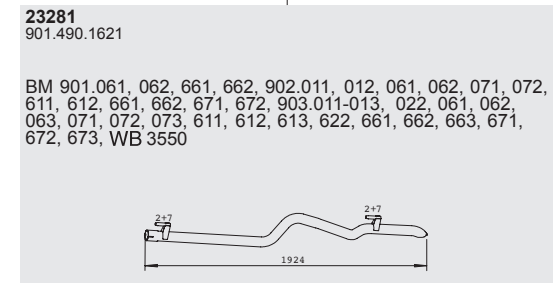
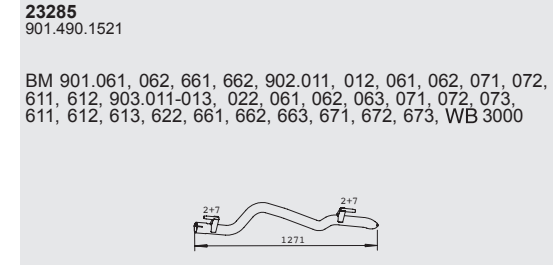

Horizontal
LHD/RHD
Standard

Series **SPRINTER**

Type

Euro 3
04/00 → 05/06



OM611 DE LA
2,1l tr.
4 cyl.
60 KW/82H P
80 KW/109 HP
95 KW/129 HP

208 CDI
211 CDI
213 CDI
308 CDI
311 CDI
313 CDI
408 CDI
411 CDI
413 CDI

Baumuster

901.611
901.612
901.621
901.661
901.662
901.671
902.611
902.612
902.621
902.622
902.661
902.662
902.671
902.672
903.611
903.612
903.613
903.621
903.622
903.623
903.661
903.662
903.663
903.671
903.672
903.673
904.612
904.613
904.622
904.623
904.662
904.663

Front pipeT

23781
901.490.3919
901.490.3319
690.490.7619

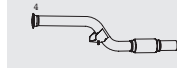

23561
901.490.2519

CAT

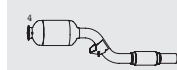

Silencer

23566
901.490.2619
901.490.3019
690.490.7719
By mountingo ft ail pipe cut and fit

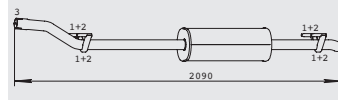

23562
901.490.1819

CAT

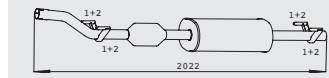

ail pipe

21376
901.492.2704

BM 901.611, 661, 662, 902.661, 662, 671, 672, 903.661, 662, 663, 671, 672, 673

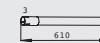

25988

901.490.4121
901.490.1021
690.490.0221

BM 903.661, 662, 663, 671, 672, 673, WB 4025

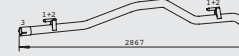

25909

901.490.4221
901.490.1321
690.490.0321

BM 903.611, 612, 613, 621, 622, 623, WB 4025



25904

904.490.2621
904.490.0921
690.490.0021

BM 904.612, 613, 622, 623, 662, 663, WB 3550

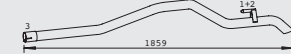

25900

904.490.1121
904.490.2721
690.490.0121

BM 904.612, 613, 622, 623, 662, 663, WB 4025



21375
901.490.2721

Lefts ide outleta ft err eara xle.

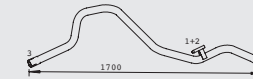

25300

901.490.4021
901.490.0921
690.490.7821

BM 901.611, 612, 621, 661, 662, 671, 902.611, 612, 621, 622, 661, 662, 671, 672, 903.611, 612, 613, 621, 622, 623, 661, 662, 663, 671, 672, 673, WB 3550

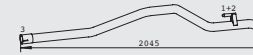

21387

904.490.1521

Lefts ide outleti n front of reara xle. BM 901.611, 612, 621, 661, 662, 671, 902.611, 612, 621, 622, 903.611, 612, 613, 621, 622, 623, 904.612, 613, 622, 623,

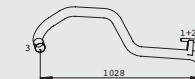

25304

901.490.3921
901.490.0821
901.490.1121

BM 901.611, 612, 621, 661, 662, 671, 902.611, 612, 621, 622, 661, 662, 671, 672, 903.611, 612, 613, 621, 622, 623, 661, 662, 663, 671, 672, 673, WB 3000

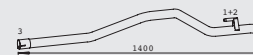

Mounting Parts

1.
28042
901.492.0044



2.
23475
901.492.4141



3.
00831
124.490.0141
901.490.0041
639.490.0041



4.
23487
202.490.0641
202.490.0841



Horizontal
LHD/RHD
Standard

Series **SPRINTER**

Type

Euro 3
04/00 → 05/06



OM611D EL A
2,1l tr.
4 cyl.
60 KW/82H P
80 KW/109 HP
95 KW/129 HP

208 CDI
211 CDI
213 CDI
308 CDI
311 CDI
313 CDI
408 CDI
411 CDI
413 CDI

Rear outlet

Baumuster

901.611
901.612
901.621
901.661
901.662
901.671
902.611
902.612
902.621
902.622
902.661
902.662
902.671
902.672
903.611
903.612
903.613
903.621
903.622
903.623
903.661
903.662
903.663
903.671
903.672
903.673
904.612
904.613
904.622
904.623
904.662
904.663

Front pipe

23785
901.490.3919
901.490.3319
690.490.7619

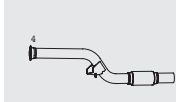

23561
901.490.2519

CAT

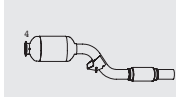

Mounting Parts

1.

28042
901.492.0044



2.

23475
901.492.4141



Horizontal
LHD/RHD
Standard

Silencer

23566
901.490.2619
901.490.3019
690.490.7719

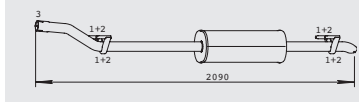

23562
901.490.1819

CAT
→ R337626

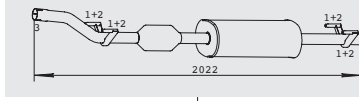

23510
901.490.2819

CAT

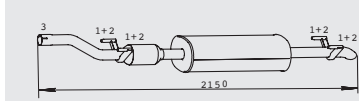

23528
901.490.4619

Retrofit system ford iesel
particulater eduction
R337627 → ,A 901274 →

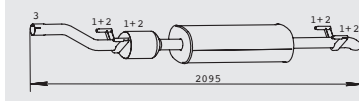

Tail pipe

25988
901.490.4121
901.490.1021
690.490.0221
BM 903.663,673, WB 4025

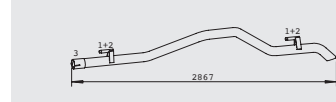

25904
904.490.2621
904.490.0921
690.490.0021
BM 904.612,622,662, WB 3550

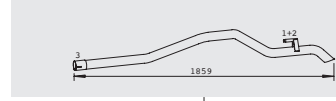

25900
904.490.1121
904.490.2721
690.490.0121
BM 904.613,623,663, WB 4025

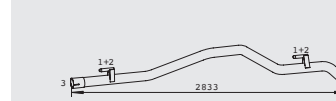

25304
901.490.3921
901.490.0821
901.490.1121
BM 901.611,621,661,671,
BM 902.611,621,661,671,
BM 903.611,621,661,671, WB 3000

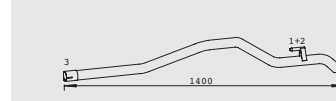

25300
901.490.4021
901.490.0921
690.490.7821
BM 901.612,662, BM 902.612,622,662,672,
BM 903.612,622,662,672, WB 3550

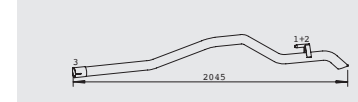

25909
901.490.4221
901.490.1321
690.490.0321
BM 903.613,623, WB 4025

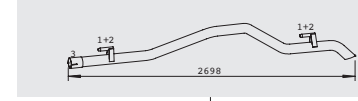

23381
904.492.1904

R337627 → ,A 901274 →
BM 904.612,613
Special pipe

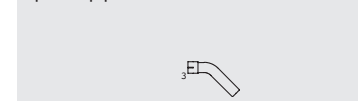

3. → R337626
00831
124.490.0141
901.490.0041
639.490.0041



3. R337627 → ,
A901274 →
00839
901.490.0141
901.490.0040
690.490.7141



4.
23487
202.490.0641
202.490.0841



Series **SPRINTER**

Type

Euro 3
04/00 → 05/06



4X2
4X4

OM611 DE LA
2,1 ltr.
4 cyl.
60 KW/82 HP
80 KW/109 HP
95 KW/129 HP

208 CDI
211 CDI
213 CDI
308 CDI
311 CDI
313 CDI
408 CDI
411 CDI
413 CDI

Side outlet

Baumuster

901.611
901.612
901.621
901.661
901.662
901.671
902.611
902.612
902.621
902.622
902.661
902.662
902.671
902.672
903.611
903.612
903.613
903.621
903.622
903.623
903.661
903.662
903.663
903.671
903.672
903.673
904.612
904.613
904.622
904.623
904.662
904.663

Front pipe

23781
901.490.3919
901.490.3319
690.490.7619

23561
901.490.2519

CAT

Mounting Parts

1.
28042
901.492.0044

3. → R337626
00831
124.490.0141
901.490.0041
639.490.0041

2.
23475
901.492.4141

3. R337627 → ,
A901274 →
00839
901.490.0141
901.490.0040
690.490.7141

Silencer

23566
901.490.2619
901.490.3019
690.490.7719

23562
901.490.1819

CAT
→ R337626

23510
901.490.2819

CAT

23528
901.490.4619

Retrofit system for diesel
particulate reduction
R337627 → , A901274 →

21376
901.492.2704

→ R337626
BM 901.662, BM 902.662,672,
BM 903.662,672, WB 3550

25987
901.492.2804

R337627 → , A901274 →
BM 901.662, BM 902.662,672
WB 3550

23275
901.490.5021

R337627 → , A901274 →
BM 903.663,673, WB 4025

4.
23487
202.490.0641
202.490.0841

Tail pipe

21375
901.490.2721

→ R337626,
Left side outlet after rear axle, BM 901.611,612,
621,661,662,671, BM 902.661,662,671,672,
BM 903.661,671, WB 3000,3550

23276
901.490.4921

Left side outlet after rear axle, BM 901.661,
662,671, BM 902.661,662,671,672,
BM 903.661,662,663,671,672,673,
WB 3000,3550,4025

21387
904.490.1521

Left side outlet in front of rear axle, BM 901.612,
661,662,671, BM 902.612,622, BM 903.612,613,
622,623, BM 904.612,613,622,623,
WB 3000,3550,4025

N A

901.490.3021
→ R337626
Behind rear axle, left
BM 903.663,673, WB 4025

Horizontal
LHD/RHD
Standard

Series **SPRINTER**

Type

Euro 3
04/00 → 05/06



OM612 DE LA
2.7l tr.
5 cyl.
115K W/156 HP

216 CDI
316 CDI
416 CDI

Baumuster

902.611
902.612
902.621
902.622
902.661
902.662
902.671
902.672
903.611
903.612
903.613
903.621
903.622
903.623
903.661
903.662
903.663
903.671
903.672
903.673
904.612
904.613
904.622
904.623
904.662
904.663

Front pipeT

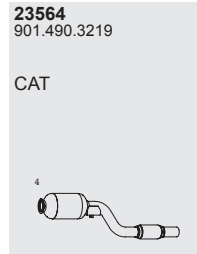
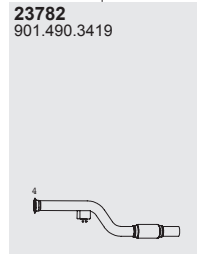

Silencer

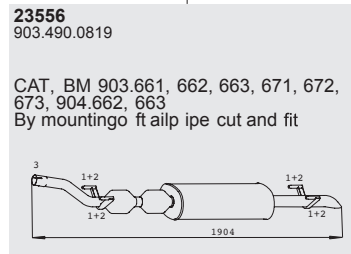
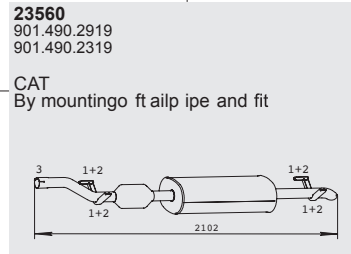
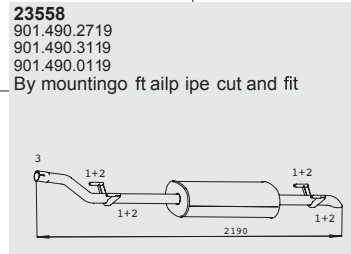

Mounting Parts

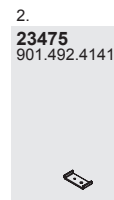
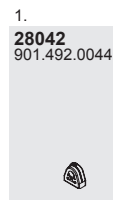

ail pipe

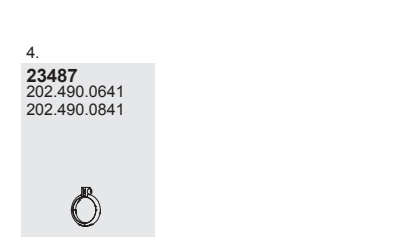
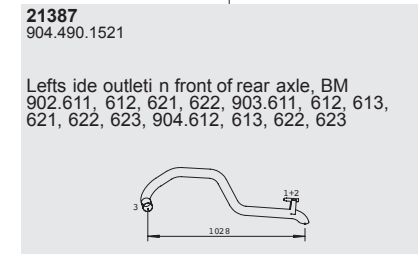
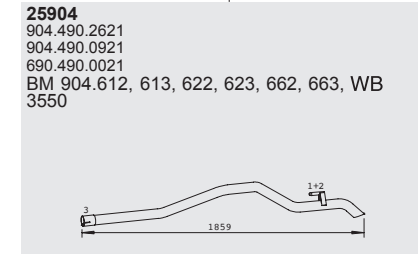
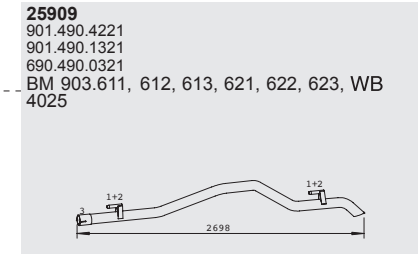
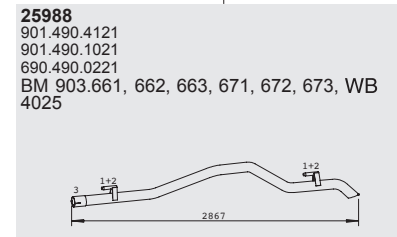
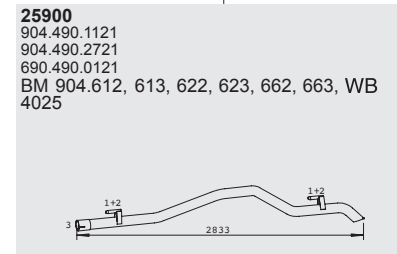
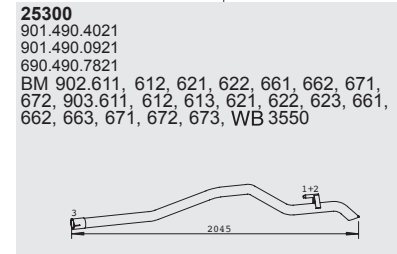
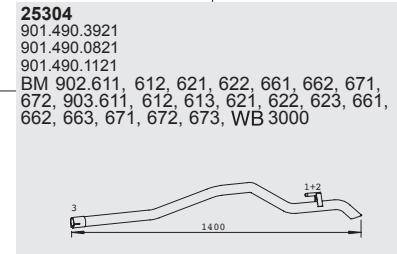

Horizontal
LHD/RHD
Standard

Series **SPRINTER**

Type

Euro 3
04/00 → 05/06



4X2
4X4

OM612 DE LA
2,7l tr.
5 cyl.
115K W/156 HP

216 CDI
316 CDI
416 CDI

Baumuster

902.611
902.612
902.621
902.622
902.661
902.662
902.671
902.672
903.611
903.612
903.613
903.621
903.622
903.623
903.661
903.662
903.663
903.671
903.672
903.673
904.612
904.613
904.622
904.623
904.662
904.663

Front pipe

23782
901.490.3419

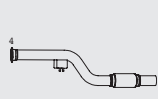

23564
901.490.3219

CAT

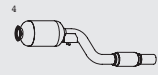

Silencer

23558
901.490.2719
901.490.3119
901.490.0119

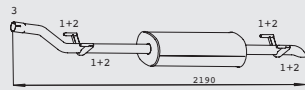

23560
901.490.2919
901.490.2319

CAT

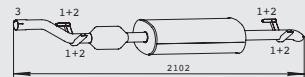

23556
903.490.0819

CAT
→ R337626,
BM 903.661,662,663,671,672,673, BM
904.662,663

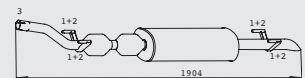

23531
901.490.4819

Retrofit system ford iesel particuler eduction
R337627 → ,A 901274 →

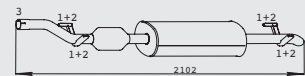

Tail pipe

25304
901.490.3921
901.490.0821
901.490.1121

BM 902.611,621,661,671,
BM 903.611,621,661,671,
WB 3000

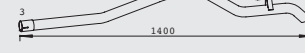

25300
901.490.4021
901.490.0921
690.490.7821

BM 902.612,622,662,672,
BM 903.612,622,662,672,
WB 3550

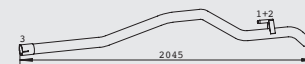

25900
904.490.1121
904.490.2721
690.490.0121

BM 904.613,623,663,
WB 4025

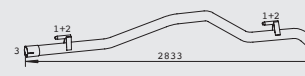

25909
901.490.4221
901.490.1321
690.490.0321

BM 903.613,623,
WB 4025

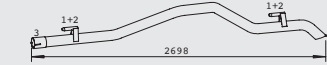

25904
904.490.2621
904.490.0921
690.490.0021

BM 904.612,622,662,
WB 3550

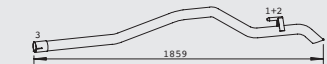

25988
901.490.4121
901.490.1021
690.490.0221

BM 903.663,673,
WB 4025

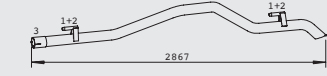

Mounting Parts

1.
28042
901.492.0044



2.
23475
901.492.4141



3. → R337626
00831
124.490.0141
901.490.0041
639.490.0041



3. R337627
A901274 →
00839
901.490.0141
901.490.0040
690.490.7141



4.
23487
202.490.0641
202.490.0841



Horizontal
LHD/RHD
Standard

Series **SPRINTER**

Type

Euro 3
04/00 → 05/06



OM612 DE LA
2,7l tr.
5 cyl.
115K W/156 HP

216 CDI
316 CDI
416 CDI

Baumuster

902.611
902.612
902.621
902.622
902.661
902.662
902.671
902.672
903.611
903.612
903.613
903.621
903.622
903.623
903.661
903.662
903.663
903.671
903.672
903.673
904.612
903.613
904.622
904.623
904.662
904.663

Front pipe

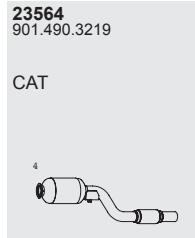
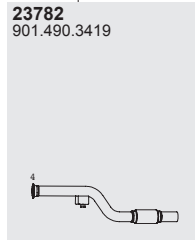

Silencer

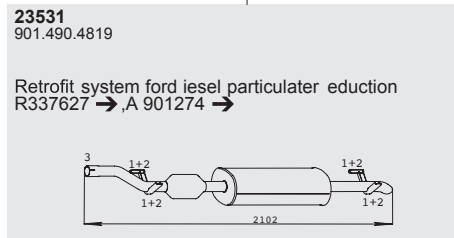
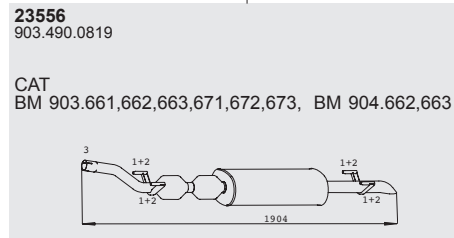
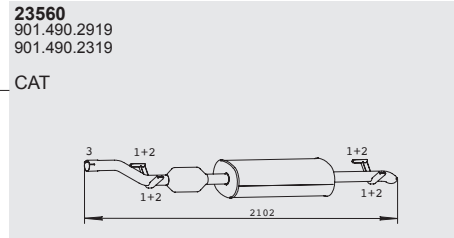
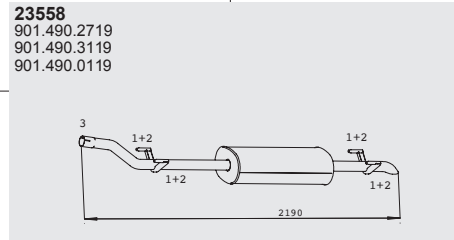

Tail pipe

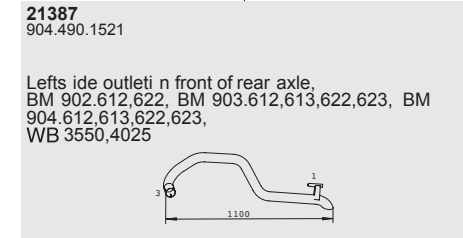
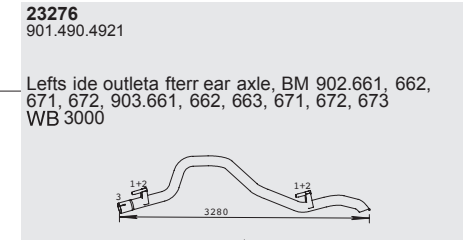
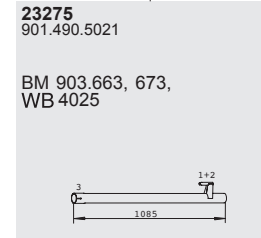

Mounting Parts

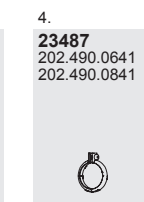
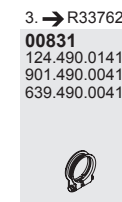
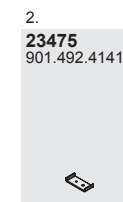
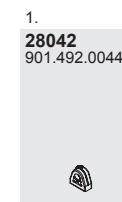

Horizontal
LHD/RHD
Standard

Series **SPRINTER**

Type

Euro 3
04/00 → 05/06



OM612 DE LA
2,7l tr.
5 cyl.
115K W/156 HP

WB 3550, 4025

616 CDI

Baumuster

905.612
905.613
905.622
905.623

Front pipe

23782
901.490.3419



Silencer

23558
901.490.2719
901.490.3119
901.490.0119
By mountingo ft ailp ipe cut and fit

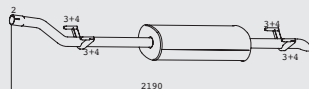

Tail pipe

23272
905.490.0221

Lefts ide outleti n front of rear axle

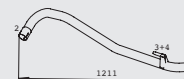

Mounting Parts

1.
23487
202.490.0641
202.490.0841



2.
00831
124.490.0141
901.490.0041
639.490.0041



3.
28042
901.492.0044



4.
23475
901.492.4141



Horizontal
LHD/RHD
Standard

Series SPRINTER

Type

Euro 3
04/00 → 05/06



WB
3000
3550
4025

OM647 DE LA
2,7l tr.
5 cyl.
130 KW/170 HP

ID No.:
R337627 →
A901274 →

316 CDI
416 CDI

Baumuster

903.611
903.612
903.613
903.621
903.622
903.623
903.661
903.662
903.663
903.671
903.672
903.673
904.612
904.613
904.622
904.623
904.662
904.663

Front pipe

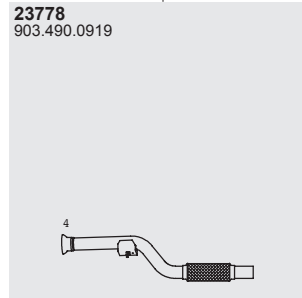

Silencer

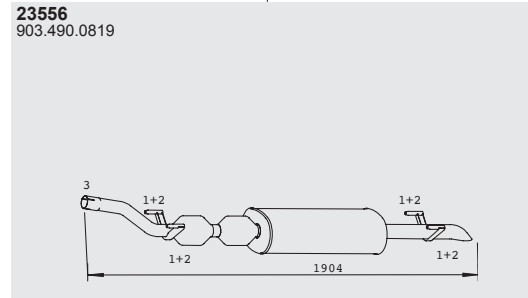

Mounting Parts

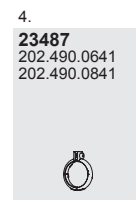
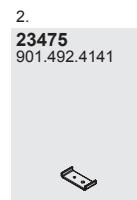
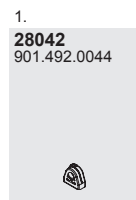

Horizontal
LHD/RHD
Standard

Series **SPRINTER**

Type

Euro 4
06/2006 →



4X2
4X4

WB
3250
3665
4325

OM646 DE LA
2,1 ltr.
4 cyl.
65 KW/88 HP
80 KW/109 HP
95 KW/129 HP
110 KW/150 HP

209 CDI
211 CDI
213 CDI
215 CDI
309 CDI
311 CDI
315 CDI
509 CDI
511 CDI
515 CDI

Baumuster

906.111
906.113
906.131
906.133
906.135
906.153
906.155
906.211
906.213
906.231
906.233
906.235
906.253
906.255
906.611
906.613
906.631
906.633
906.635
906.637
906.653
906.655
906.657
906.711
906.713
906.731
906.733
906.735
906.737

Horizontal
LHD/RHD
Standard

Front pipe

23550
906.490.1481

CAT.
Euro 3/4, 65, 80 KW
Euro 3 110 KW

23777
906.490.1981

Euro 3
65,80,110 KW

23518
906.490.1581

CAT.
Euro 4
95,110 KW

23515
906.490.2581

CAT.
Euro 4
95,110 KW
AWD

23512
906.490.0592

DPF
Euro 4
Total weight over 3500 KG

23519
906.490.0992

DPF
Euro 4

Mounting Parts

1.
23474
203.490.0441

2.
28414
000.492.0981
000.492.0481

Silencer

23525
906.490.1001

Euro 4

23523
906.490.2101
906.490.1501

Euro 3, 65,80,110 KW
Without DPF

23521
906.490.1101

Euro 4

23529
906.490.2201
906.490.1601

Euro 3, 65,80,110 KW
Without DPF

Tail pipe

91381
906.490.0021

BM 906.111,131,211,231,611,
631,711,731, WB 3250

91382
906.490.0121

BM 906.113,133,213,233,613,
633,713,733, WB 3665

91377
906.490.2621

BM 906.153,253,653,
WB 3665

3.
91477
000.490.1341

4.
00897
906.995.0202

5.
23470
000.995.5302

6.
28042
901.492.0044

91378
906.490.0221

BM 906.135,235,635,637,
735,737, WB 4325

91376
906.490.2821

BM 906.655,657, WB 4325

23385
906.490.4321
906.490.3621

BM 906.155,255, WB 4325

Series **SPRINTER**

Type

Euro 4
06/2006 →



WB
3665
4325

OM646 DE LA

2,1l tr. CDI
4 cyl.
65 KW/88H P
80 KW/88H P
95 KW/129 HP
110K W/150 HP

209 CDI
211 CDI
213 CDI
215 CDI
309 CDI
311 CDI
315 CDI

Baumuster

906.613
906.633
906.635
906.637
906.713
906.733
906.735
906.737

Front pipeS

23550
906.490.1481

CAT.
Euro 3, 65,80,110K W
Euro 4, 65,80 kW

23777
906.490.1981

Euro 3
65,80,110K W

23518
906.490.1581

CAT.
Euro 4
95,110K W

23515
906.490.2581

CAT.
Euro 4
95,110K W
AWD

23512
906.490.0592

DPF
Euro 4
Totalw eight over 3500 KG

23519
906.490.0992

DPF
Euro 4

ilencer

23525
906.490.1001

Euro 4

23523
906.490.2101
906.490.1501

Euro 3
65,80,110K W
Without DPF

23521
906.490.1101

Euro 4

23529
906.490.2201
906.490.1601

Euro 3
65,80,110K W
Without DPF

Tail pipe

91374
906.490.0521

BM 906.613,633,713,733,
WB 3665

91368
906.490.1021

BM 906.635,637,735,737,
WB 4325

Mounting Parts

1.
23474
203.490.0441

2.
28414
000.492.0981
000.492.0481

3.
91477
000.490.1341

4.
00897
906.995.0202

5.
23470
000.995.5302

6.
28042
901.492.0044

Horizontal
LHD/RHD
Standard

Series **SPRINTER**

Type

Euro 4
06/2006 →



4X2
4X4

WB
3600
4100
4325

OM642 DE LA
3,0l tr.
6 cyl.
135 KW/184 HP

218 CDI
318 CDI
518 CDI

Baumuster

906.113
906.132
906.133
906.134
906.135
906.136
906.153
906.155
906.213
906.233
906.235
906.253
906.255
906.613
906.633
906.635
906.637
906.713
906.733
906.735
906.737

Front pipe

23516
906.490.2381

CAT.

23511
906.490.4581

CAT.
AWD

23514
906.490.1192

DPF

23513
906.490.0792

DPF
Totalw eight over
3500 KG

Silencer

23525
906.490.1001

23521
906.490.1101

Tail pipe

91365
906.490.1121

Exhaust downstreama ts ideo fl eft
reara xle,
Excl.M ain tank 100 ltr.
BM 906.113,133,153,213,
233,253, WB 3665

23386
906.490.3321

Exhaust downstreama ts ideo fl eft
reara xle,
BM 906.132,134,136,
WB 3600,3850,4100

91361
906.490.1221

Exhaust ats ideo downstreamo fr eara xle,
BM 906.613,633,713,733,
WB 3665

91362
906.490.1321

Exhaust downstreama ts ideo
of left reara xle,
BM 906.135,155,235,255,
WB 4325

91366
906.490.0921

Exhaust ats ideo downstreamo fr eara xle,
BM 906.635,637,735,737,
WB 4325

Mounting Parts

1.
23466
219.492.0080

2.
00897
906.995.0202

3.
23470
000.995.5302

4.
28042
901.492.0044

Horizontal
LHD/RHD
Standard

Series **SPRINTER**

Type

Euro 4
06/2006 →



WB
3250
3665
4325

OM642 DE LA
3,0 ltr.
6 cyl.
115 KW/156 HP
135 KW/184 HP

218 CDI
318 CDI
518 CDI

Baumuster

906.111
906.113
906.131
906.133
906.135
906.153
906.155
906.211
906.213
906.231
906.233
906.235
906.253
906.255
906.611
906.613
906.631
906.633
906.635
906.637
906.653
906.655
906.657
906.711
906.713
906.731
906.733
906.735
906.737

Front pipe

23516
906.490.2381

CAT.
135 KW



23511
906.490.4581

CAT.
135 KW
AWD



N. A.

CAT.
906.490.2081
115 KW

23514
906.490.1192

DPF
135 KW



23513
906.490.0792

DPF
135 KW
Total weight over
3500 KG



N. A.

DPF
906.490.1592
Excl. 906.490.131
115 KW

Silencer

23525
906.490.1001

135 KW

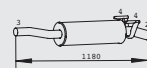

23521
906.490.1101

135 KW

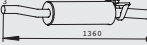

23522
906.490.1201

115 KW

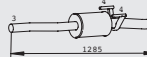

N. A.

906.490.1301
115 KW

Tail pipe

91371
906.490.0721

BM 906.111,131,211,231,611,
631,711,713, WB 3250



91372
906.490.0821

BM 906.113,133,213,233,
613,633,713,733, WB 3665



91383
906.490.2021

BM 906.153,253,
WB 3665

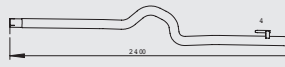

91384
906.490.2521

BM 906.653,
WB 3665

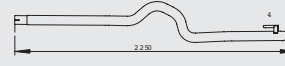

91373
906.490.1421

BM 906.135,235,635,637,735,737,
WB 4325



91379
906.490.1721

BM 906.655,657,
WB 4325

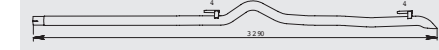

91375
906.490.4421
906.490.3721

BM 906.155,255,
WB 4325

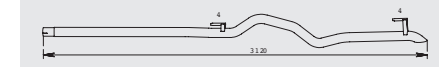

91389
906.490.2121

115 KW
BM 906.657, WB 4325

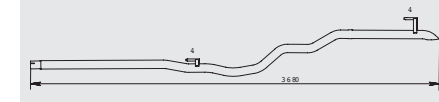

Mounting Parts

1.
23468
219.492.0080



2.
00897
906.995.0202



3.
23470
000.995.5302



4.
28042
901.492.0044



Horizontal
LHD/RHD
Standard

Series **SPRINTER**

Type

Euro 3/4
06/2006 →



④X②
④X④

WB
3600
3665
3850
4100
4325

☞ **OM646 DE LA**
2,1l tr.
4 cyl.
65 KW/88H P
80 KW/109 HP
95 KW/129 HP
110K W/150 HP

209 CDI
211 CDI
213 CDI
215 CDI
309 CDI
311 CDI
315 CDI
509 CDI
511 CDI
515 CDI

Horizontal
LHD/RHD
Standard

Baumuster

906.113
906.132
906.133
906.134
906.135
906.136
906.153
906.155
906.213
906.233
906.235
906.253
906.255

Front pipe

23550
906.490.1481

CAT.
Euro 3/4, 65,80 KW
Euro 3, 110K W

23777
906.490.1981

Euro 3
65,80,110K W

23518
906.490.1581

CAT.
Euro 4
95,110K W

23515
906.490.2581

CAT.
Euro 4
95,110K W
AWD

23512
906.490.0592

DPF
Euro 4
Totalw eight over 3500 KG

23519
906.490.0992

DPF
Euro 4

Silencer

23525
906.490.1001

Euro 4

23523
906.490.2101
906.490.1501

Euro 3
65,80,110K W
Without DPF

23521
906.490.1101

Euro 4

23529
906.490.2201
906.490.1601

Euro 3
Without DPF

23527
906.490.0801

BM 906.132,134,136

23526
906.490.0901

BM 906.132,134,136

Mounting Parts

1.
23474
203.490.0441

3.
91477
000.490.1341

2.
28414
000.492.0981
000.492.0481

4.
00897
906.995.0202

91370
906.490.0621

BM
906.113,133,153,213,233,253,
WB 3665
Excl.M ainT ank 100 ltr.

91367
906.490.1621

BM 906.135,155,235,255,
WB 4325

23383
906.490.3221

80,95,110K W
BM 906.132,134,136
WB 3600,3850,4100

5.
23470
000.995.5302

6.
28042
901.492.0044

Series TOURISMO

Type

Euro III
09/2003 →



O 350

Tourismo 15 RHD

OM 457.941
12,0l tr.
6 cyl.
185 KW/252 HP

OM 457.952
OM 457.965
12,0l tr.
6 cyl.
220 KW/299 HP

Baumuster

632.036

Front pipe

Silencer

21670
629.490.2010
629.490.0910

AEM Insulation



27516
629.490.0301
629.490.0101



Mounting Parts

1.
27401
942.997.0290
000.995.8602



2.
00961
071.555.124.500
000.492.1240
000.492.0040



3.
30481
000.491.0285



Horizontal
LHD/RHD
Standard

Series TOURISMO

Type

Euro III
09/2003 →



O 350

Tourismo 17 RHD

OM 457.944
OM 457.953
OM 457.961
12,0l tr.
6 cyl.
260 KW/354 HP

Baumuster

632.037

Front pipe

21674
634.490.0210

AEM Insulation



30731
629.490.1210

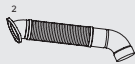

Silencer

30555
629.491.0700

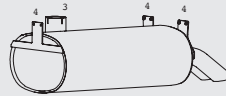

Mounting Parts

1.
27401
942.997.0290
000.995.8602



2.
30472
629.492.0080



3.
00961
071.555.124.500
000.492.1240
000.492.0040



4.
30481
000.491.0285



Horizontal
LHD/RHD
Standard

Series TOURISMO

Type

Euro III
09/2003 →



O 350

Tourismo
O403-RHD
Tourismo
O403-SHD

OM 457.944
12,0l tr.
6 cyl.
260 KW/354 HP
310 KW/422 HP

Baumuster

613.358
613.388

Front pipe

23771
613.490.0220



27548
613.490.00001



Silencer

27598
613.491.0000

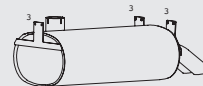

Mounting Parts

1.
27401
942.997.0290
000.995.8602



2.
00961
071.555.124.500
000.492.1240
000.492.0040



3.
30481
000.491.0285



Horizontal
LHD/RHD
Standard

Series TOURISMO

Type

Euro IV
10/03 →



④X②
⑥X②

O 350

Tourismo 15 RHD
Tourismo 16 RHD

OM 457 HLA

12,0l tr.
6 cyl.
185 KW/252 HP
220 KW/299 HP
260 KW/354 HP
300 KW/408 HP

Baumuster

632.036
632.038

Front pipeT

21648
633.490.1210
633.490.1310
633.490.1810



21667
633.490.1010
633.490.1610

Insulation



Silencer

27596
001.490.2814

SCR



27595
001.490.4914

SCR
With NOx sensor



ail pipe

21330
633.490.0327

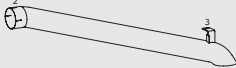

21347
633.490.0527

Inox
With NOx sensor

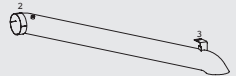

Mounting Parts

1.
27401
942.997.0290
000.995.8602



2.
00961
071.555.124.500
000.492.1240
000.492.0040



3.
30481
000.491.0285



Horizontal
LHD/RHD
Standard

Series TOURISMO

Type

Euro IV
01/05 →



O 350

Tourismo 16 RHD
Tourismo 17 RHD

OM 457 LA
12,0l tr.
6 cyl.
260 KW/354 HP
315 KW/428 HP

Baumuster

632.035
632.037

Front pipe

21679
632.490.0410

AEM Insulation



21676
632.492.0004
632.490.0810



Silencer

27590
001.490.2914
000.490.8214

SCR



Tail pipe

21339
632.490.0210

AEM

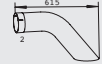

Mounting Parts

1.
27431
942.997.0290
000.995.8602



2.
00011
634.492.0740



Horizontal
LHD/RHD
Standard

Series TOURO

Type

Euro III
2000 →



OM 457 LA
12,0l tr.
6 cyl.
260 KW/354 HP
310 KW/422 HP

Baumuster

634.203

Front pipe

30732
629.490.1010
629.490.0610



30557
629.491.0400

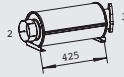

30731
629.490.1210

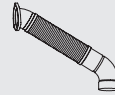

Silencer

30558
629.491.0300

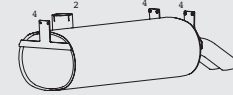

Mounting Parts

1.
27401
942.997.0290
000.995.8602



2.
00961
071.555.124.500
000.492.1240
000.492.0040



3.
30472
629.492.0080



4.
30481
000.491.0285



Horizontal
LHD/RHD
Standard

Series TRAVEGO

Type

Euro III
10/99 →



O 580

Travego 15RH

OM 457.940
6 cyl.
12 ltr.
260 KW/354 HP

Baumuster

629.001

Front pipe

21670
629.490.2010
629.490.0910

AEM Insulation



Silencer

27516
629.490.0301
629.490.0101

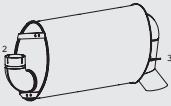

Mounting Parts

1.
27401
942.997.0290
000.995.8602



2.
00961
071.555.124.500
000.492.1240
000.492.0040



3.
30481
000.491.0285



Horizontal
LHD/RHD
Standard

Series TRAVEGO

Type

Euro III
10/99 →



④X②
⑥X②

O 580

Travego 15 RHD
Travego 16 RHD
Travego 17 RHD

🔧 **OM 457.936**
🔧 **OM 457.940**
🔧 **OM 457.944**
12,0l tr.
6 cyl.
260 KW/354 HP
300 KW/408 HP

🔧 **OM 942.900**
🔧 **OM 942.911**
🔧 **OM 942.948**
16,0l tr.
8 cyl.
300 KW/408 HP
320 KW/435 HP
350 KW/476 HP

Baumuster

629.011
629.012
629.015

Front pipe

30732
629.490.1010
629.490.0610



30557
629.491.0400

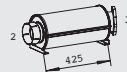

30731
629.490.1210

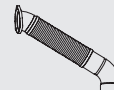

21678
629.490.0310



30735
629.490.0810

BM 629.012.015



21672
629.490.1910

AEM Insulation
BM 629.012,015



Silencer

30558
629.491.0300

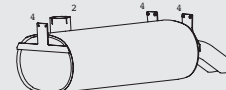

Mounting Parts

1.
27401
942.997.0290
000.995.8602



2.
00961
071.555.124.500
000.492.1240
000.492.0040



3.
30472
629.492.0080



4.
30481
000.491.0285



5.
28043
942.997.0090



Horizontal
LHD/RHD
Standard

Series TRAVEGO

Type

Euro III
10/99 →



O 580

Travego 15 SHD
Travego 17 SHD

OM 457.944
12,0l tr.
6 cyl.
260 KW/354 HP

OM 542.948
16,0l tr.
8 cyl.
320 KW/435 HP

Baumuster

632.010
632.012

Front pipe

21218
634.490.0210

AEM Insulation
BM 632.010
VST.LI.



30731
629.490.1210



30735
629.490.0810

BM 632.012
▶CHno 242235



21672
629.490.1910

AEM Insulation
BM 632.012
242236 ▶CHno



21673
629.490.2310

AEM
BM 632.012



Silencer

30555
629.491.0700

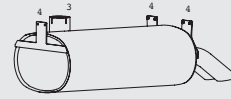

Mounting Parts

1.
21401
942.997.0290
000.995.8602



2.
30472
629.492.0080



3.
00961
071.555.124.500
000.492.1240
000.492.0040



4.
30481
000.491.0285



5.
28043
942.997.0090



Horizontal
LHD/RHD
Standard

Series TRAVEGO

Type

Euro IV
01/04 →



O 580

Travego 16 RHD

OM 457 LA
12,0l tr.
6 cyl.
260 KW/354 HP

Baumuster

632.005
632.007

Front pipe

21677
632.490.0010
632.490.0910

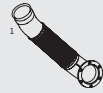

Silencer

27546
001.490.3014

SCR

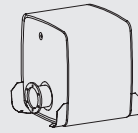

Tail pipe

21334
632.490.0310

AEM



Mounting Parts

1.
27401
942.997.0290
000.995.8602



2.
00011
634.492.0740



Horizontal
LHD/RHD
Standard

Series TRAVEGO

Type

Euro IV
01/04 →



O 580



Travego 15 RHD



Travego 16 RHD

OM 457 LA
12,0l tr.
6 cyl.
260 KW/354 HP

Baumuster

632.005
632.006
632.007

Front pipe

21679
632.490.0410

AEM Insulation



21676
632.492.0004
632.490.0810



Silencer

27590
001.490.2914
000.490.8214

SCR
241321 ▶CHno



27547
002.490.2314

SCR
WithN Ox sensor



Tail pipe

21339
632.490.0210

AEM



21334
632.490.0310

AEM
Used with silencer
51381



Mounting Parts

1.
27401
942.997.0290
000.995.8602



2.
00011
634.492.0740



Horizontal
LHD/RHD
Standard

Series VARIO

Type

Euro II
09/96 →



WB 3150, 3700,
4250, 4800

OM602 DE LA
2,9l tr.
5 cyl.
90 KW/122 HP

OM904 LA
4,25 ltr.
4 cyl.
100 KW/136 HP

612 D
614 D
812 D
814 D

Baumuster

668.321
668.322
668.323
668.331
668.332
668.351
668.352
668.353
670.353
670.351
670.352

Front pipeT

21784
668.490.3319
668.490.3019
OM 904

25617
667.490.2619
OM 602

25788
668.490.3219
OM 904

25616
668.490.3119
OM 602

Silencer

28112
667.490.0001

18574
CATS ilencer

ail pipe

25953
668.492.5504

25952
668.492.4604
Used with underrun protection

21374
668.492.6604
WB 4250, 4800

28932
668.492.2804

21379
668.492.6304
WB 4250, 4800

Mounting Parts

1.
00932
071.555.065.501

2.
28099
667.492.5741

3.
28012
668.492.0340

4.
28063
673.492.0140
313.392.0340

5.
28094
667.490.0441

6.
28480
381.492.0082
301.492.0382
0201.175.00

7.
28478
620.997.0490

8.
00992
071.555.075.502

Horizontal
LHD
Standard

Series VARIO

Type

Euro II
09/96 →



WB 3150, 3700,
4250, 4800

OM602 DE LA
2,9l tr.
5 cyl.
90 KW/122 HP

OM 904
4,25 ltr.
4 cyl.
100 KW/136 HP

612 D
614 D
812 D
814 D

Baumuster

668.321
668.322
668.323
668.331
668.332
668.351
668.352
668.353
670.351
670.352
670.353

Front pipe

21784
668.490.3319
668.490.3019

OM 904



25617
667.490.2619

OM 602



25788
668.490.3219

OM 904



25616
668.490.3119

OM 602



Silencer

28112
667.490.0001

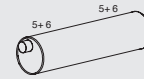

18574

Cat.

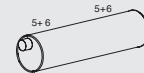

25916
668.492.6404

►CHno 079.193
WB 4800

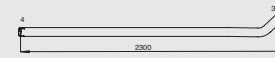

25918
668.492.5804

►CHno 079.193
WB 3700, 4250

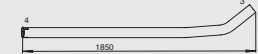

25917
668.492.5604

►CHno 079.193
WB 3150

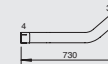

Tail pipe

25959
668.492.5904

Rear outleta ferr ear axle.

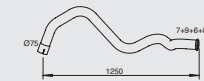

25919
668.492.6204
668.492.6504

Rear outlet
WB 4250
BM 667.323, 353, 668.323, 353,
670.323, 353, 373
WB 4800
BM 370.324, 374

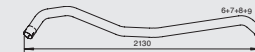

25915
668.492.6104

WB 3700
rear outlet

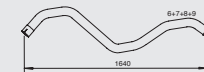

25911
668.492.6004

WB 3150
rear outlet

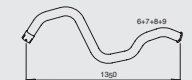

Mounting Parts

1.
00932
071.555.065.501



2.
28099
667.492.5741



3.
28012
668.492.0340



4.
28063
673.492.0140
313.392.0340



5.
28094
667.490.0441



6.
28480
381.492.0082
301.492.0382
0201.175.00



7.
00992
071.555.075.502



8.
27479
620.492.6241
396.492.3241



9.
28048
667.492.6241
662.492.6241



10.
28478
620.997.0490



11. Kit
18893



12. Cat.retrofit
18573



13. Kit
18833



Horizontal
LHD/RHD
Standard

Series VARIO

Type

Euro III
09/96 →



WB 3150, 3700,
4250, 4800

OM 904 LA
4,25 ltr.
4 cyl.
100 KW/136 HP
115K W/156 HP

614 D
616 D
814 D
816 D

Baumuster

668.321
668.322
668.323
668.331
668.332
668.351
668.352
668.353
670.351
670.352
670.353

Front pipe

21604
668.490.4319

23775
670.492.1901

21602
670.490.0265
674.490.0065
673.490.0165

21606
668.492.8804

Silencer

28559
676.490.0201

Tail pipe

21985
668.492.8504

Used with underrun protection

21393
668.492.8904

WB 4250, 4800

Mounting Parts

1.
28478
620.997.0490

2.
28012
668.492.0340

3.
28069
676.492.0040

4.
28438
674.491.4541
674.491.2641

5.
28480
381.492.0082
301.492.0382
0201.175.00

Horizontal
LHD/RHD
Standard

Series VARIO

Type

Euro III
09/96 →

④X②
④X④

OM 904.904
4,25 ltr.
4 cyl.
75 KW/104 HP

OM 904.908
4,25 ltr.
4 cyl.
100 KW/136 HP

OM 904.923
4,25 ltr.
4 cyl.
112K W/152 HP

WB
3150,3700,4250
5,99 ton, 7,49 ton

- 613 D
- 614 D
- 615 D
- 616 D
- 813 D
- 814 D
- 815 D
- 816 D
- 813 DA
- 814 DA
- 815 DA
- 816 DA

WB 4250,4800
7,49 ton

- O 810
- O 814
- O 815

Horizontal
LHD/RHD
Standard

Baumuster

669.599
669.899

Front pipe

21784
668.490.3319
668.490.3019



21604
668.490.4319



23775
670.492.1901



25788
668.490.3219

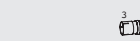

21602
670.490.0265
674.490.0065
673.490.0165



21606
668.492.8804



Silencer

28112
667.490.0001

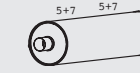

28559
676.490.0201

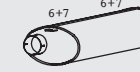

Tail pipe

25953
668.492.5504



25952
668.492.4604

Used with underrun protection



28932
668.492.2804



21985
668.492.8504

Used with underrun protection



21379
668.492.6304

RHD
WB 4250/4800 mm



21374
668.492.6604

RHD
WB 4250/4800 mm



21393
668.492.8904

RHD
WB 4250/4800 mm

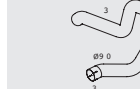

Mounting Parts

1.
28478
620.997.0490



2.
28012
668.492.0340



3.
28069
676.492.0040



4.
28063
673.492.0140
313.392.0340



5.
28094
667.490.0441



6.
28438
674.491.4541
674.491.2641



7.
28480
381.492.0082
301.492.0382
0201.175.00



8.
00992
071.555.075.502



Series VARIO

Type

Euro III
1996 →



4X4

7,49 ton

OM 904.908
4,25ltr.
4 cyl.
100 KW/136 HP

813 DA
814 DA

OM 904.923
4,25 ltr.
4 cyl.
112K W/152 HP

815 DA
816 DA

Baumuster

669.599
669.899

Front pipe

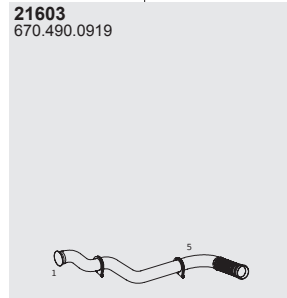

Silencer

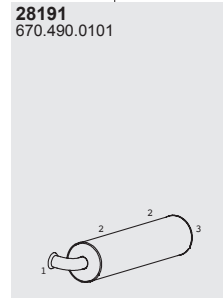

Tail pipe

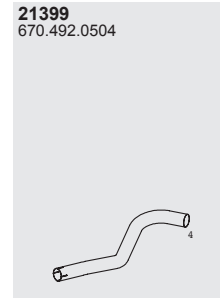

Mounting Parts

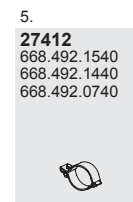
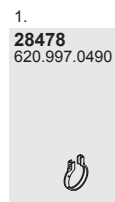

Horizontal
LHD
Standard

SOYLU / OTOBÜS

NEOPLAN

Cityliner	364
Jetliner	368
N 316	373
N 414	374
Skyliner	375
Starliner	377
Tourliner	380
Transliner	381

Series CITYLINER

Type

Euro I



N1 16
N 217

OM 402
12,8l tr.
8 cyl.
176 KW/240 HP
188 KW/256 HP

OM 422
14,6l tr.
8 cyl.
184 KW/250 HP
206 KW/280 HP

OM 403
16,0l tr.
10 cyl.
235 KW/320 HP
264 KW/360 HP

Front pipe

Silencer

Tail pipe

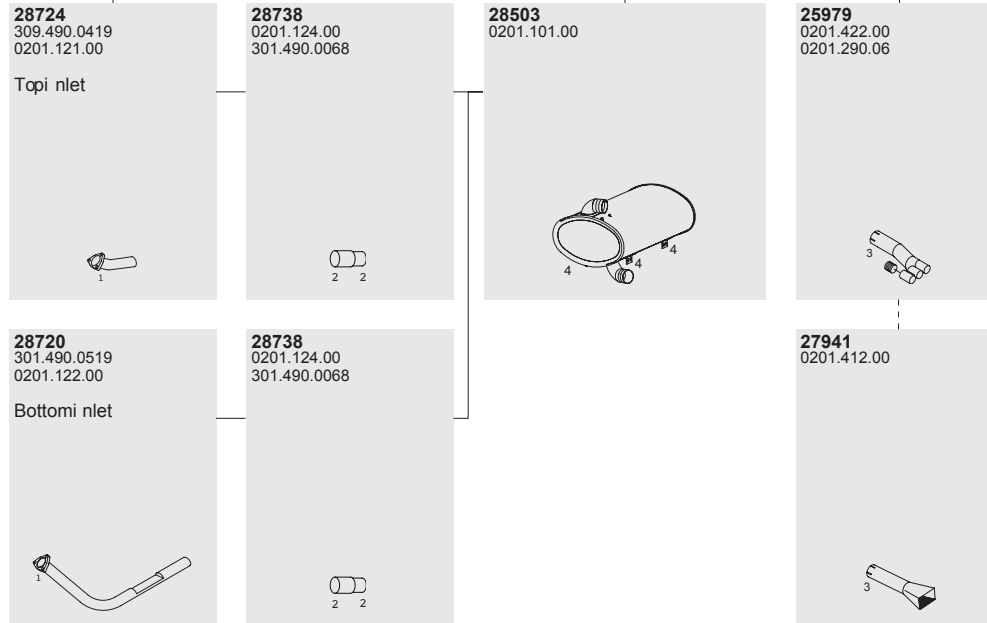

Mounting Parts

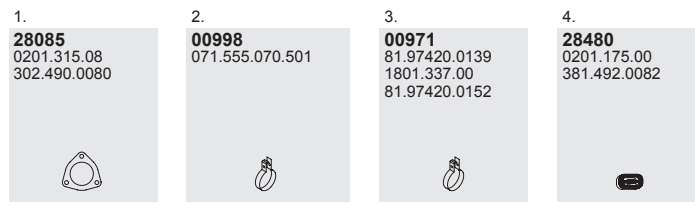

Horizontal
LHD
Standard

Series CITYLINER

Type

Euro II



OM 442 A
14,6l tr.
8 cyl.
250 KW/340 HP

Front pipe

25614
0221.311.00

Topi nlet

27721
300.492.0059
0201.16.00

25610
0201.750.300
0201.309.00

26662
0201.161.01
300.490.0519
300.490.0319
Bottomi nlet

25628
0201.750.700
0221.313.00

27721
300.492.0059
0201.16.00

25627
0221.312.00

Silencer

30585
0201.113.00

Tail pipe

30388
0221.310.00

30388
0221.310.00

Mounting Parts

1.
28085
0201.315.08
302.490.0080

2.
00901
1801.348.00
1801.315.00

3.
00942
1801.409.00

Horizontal
LHD
Standard

Series CITYLINER

Type



N 122

OM 422 A
14,6l tr.
8 cyl.
243 KW/330 HP

OM 442 A
14,6l tr.
8 cyl.
250 KW/340 HP

OM 403 A
16,0l tr.
10 cyl.
264 KW/360 HP

Front pipe

26669
300.490.0119
0201.152.00



27721
300.492.0059
0201.16.00



26661
300.490.0219
0201.164.00



Silencer

28177
300.490.0001
0201.151.00

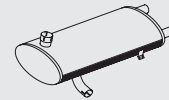

Tail pipe

N.A.

0201.419.00

26662
0201.161.01
300.490.0519
300.490.0319



26663
300.490.0619



27721
300.492.0059
0201.16.00



26662
0201.161.01
300.490.0519
300.490.0319



26667
300.490.0419

OM403A



Mounting Parts

1.
28075
11006118



2.
00901
1801.348.00
1801.315.00



Horizontal
LHD
Standard

Series CITYLINER

Type

Euro II



OM 402 A
12,8l tr.
8 cyl.
176 KW/240 HP
188 KW/250 HP

OM 402 LA
12,8l tr.
8 cyl.
250 KW/340 HP

Front pipe

25698
0221.330.00
0221.166.00
Topi nlet



27721
300.492.0059
0201.16.00



25696
0221.331.00



25695
0221.308.00
0221.328.00
0221.335.00
Bottomi nlet



25628
0201.750.700
0221.313.00

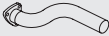

27721
300.492.0059
0201.16.00



25697
0221.312.10



Silencer

28138
0221.014.00
16.19.190.01.000

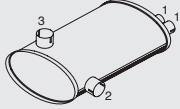

25970
0221.606.00



25968
0201.423.00



Tail pipe

Mounting Parts

1.
00971
81.97420.0139
1801.337.00
81.97420.0152



2.
00901
1801.348.00
1801.315.00



3.
00981
1801.407.00
11032405



4.
28085
0201.315.08
302.490.0080



Horizontal
LHD
Standard

Series JETLINER

Type

Euro I



N1 16
N 217

OM 402
12,8l tr.
8 cyl.
176 KW/240 HP
188 KW/256 HP

OM 422
14,6l tr.
8 cyl.
184 KW/250 HP
206 KW/280 HP

OM 403
16,0l tr.
10 cyl.
235 KW/320 HP
264 KW/360 HP

Horizontal
LHD
Standard

Front pipe

28724
309.490.0419
0201.121.00

Topi nlet



28738
0201.124.00
301.490.0068



28720
301.490.0519
0201.122.00

Bottomi nlet



28738
0201.124.00
301.490.0068



Silencer

28503
0201.101.00

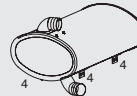

Tail pipe

25979
0201.422.00
0201.290.06



27941
0201.412.00



Mounting Parts

1.
28085
0201.315.08
302.490.0080



2.
00998
071.555.070.501



3.
00971
81.97420.0139
1801.337.00
81.97420.0152



4.
28480
0201.175.00
381.492.0082



Series JETLINER

Type

Euro II



OM 442 A
14,6l tr.
8 cyl.
250 KW/340 HP

Front pipe

25614
0221.311.00

Topi nlet



27721
300.492.0059
0201.16.00



25610
0201.750.300
0201.309.00



26662
0201.161.01
300.490.0519
300.490.0319
Bottomi nlet



25628
0201.750.700
0221.313.00



27721
300.492.0059
0201.16.00



25627
0221.312.00



Silencer

30585
0201.113.00

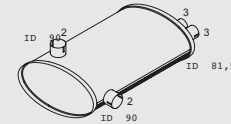

Tail pipe

30388
0221.310.00



30388
0221.310.00



Mounting Parts

1.
28085
0201.315.08
302.490.0080



2.
00901
1801.348.00
1801.315.00



3.
00942
1801.409.00



Horizontal
LHD
Standard

Series JETLINER

Type

Euro I



N 216

OM 422

14,6l tr.
8 cyl.
184 KW/250 HP
206 KW/280 HP

Front pipe

Silencer

Tail pipe

28724
309.490.0419
0201.121.00

Topi nlet



28738
0201.124.00
301.490.0068



28575
301.490.0501
0201.111.00

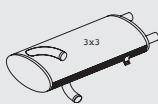

28354
301.492.0104

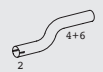

28720
301.490.0519
0201.122.00

Bottomi nlet



28738
0201.124.00
301.490.0068



28354
301.492.0104



Mounting Parts

1.
00998
071.555.070.501



2.
00995
071.555.073.500



3.
28480
0201.175.00
381.492.0082



4.
28078
001.987.5340



5.
28085
0201.315.08
302.490.0080



6.
28486
301.492.0040



Horizontal
LHD
Standard

Series JETLINER

Type

Euro I



N 216

OM 422

14,6l tr.
8 cyl.
184 KW/250 HP
206 KW/280 HP

Front pipe

Silencer

Tail pipe

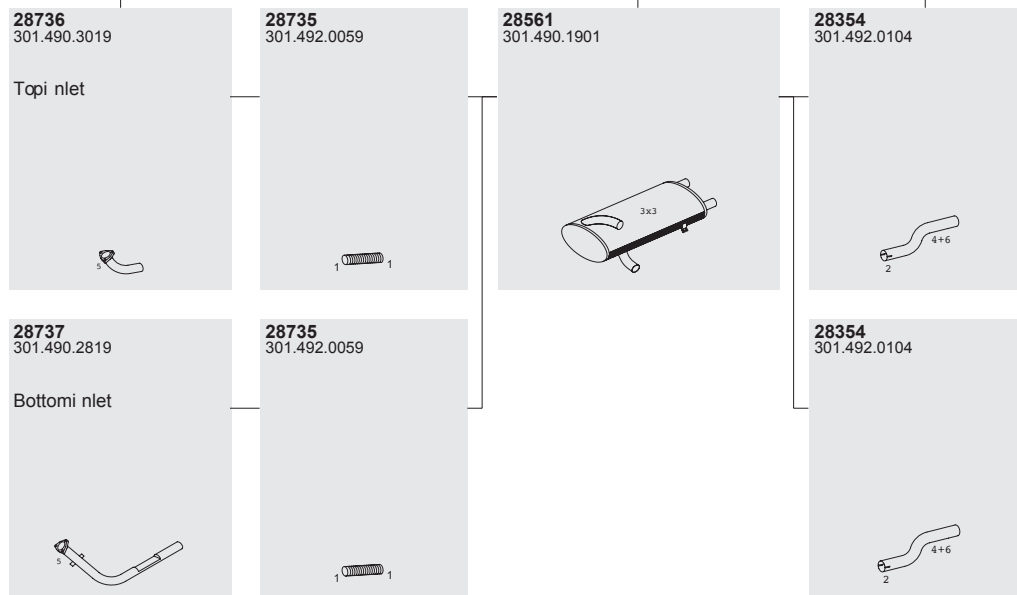

Mounting Parts

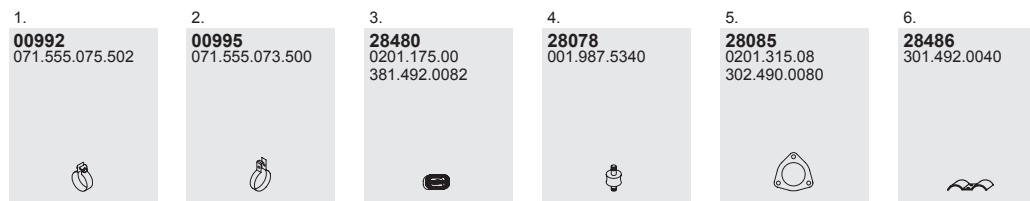

Horizontal
LHD
Standard

Series JETLINER

Type

Euro II



OM 402 A
12,8l tr.
8 cyl.
176 KW/240 HP
188 KW/256 HP

OM 402 LA
12,8l tr.
8 cyl.
250 KW/340 HP

Front pipe

25698
0221.330.00
0221.166.00
inlet

27721
300.492.0059
0201.16.00

25696
0221.331.00

25695
0221.308.00
0221.328.00
0221.335.00
Bottom inlet

25628
0201.750.700
0221.313.00

27721
300.492.0059
0201.16.00

25697
0221.312.10

Silencer

28138
0221.014.00
16.19.190.01.000

25970
0221.606.00

25968
0201.423.00

Tail pipe

Mounting Parts

1.
00971
81.97420.0139
1801.337.00
81.97420.0152

2.
00901
1801.348.00
1801.315.00

3.
00981
1801.407.00
11032405

4.
28085
0201.315.08
302.490.0080

Horizontal
LHD
Standard

Series N 316

Type

Euro I



N316

OM 442

15,0l tr.
8 cyl.
195 KW/265 HP
206 KW/280 HP
213 KW/290 HP

Front pipe

25630
0201.804.21

Topi nlet



25634
0201.374.00



25639
0201.804.22



28120
0201.101.10

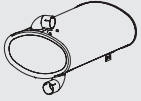

25979
0201.422.00
0201.290.06



25633
0201.804.10
0201.804.00

Bottomi nlet



25634
0201.374.00



25631
W397/1B



Mounting Parts

1.
28085
0201.315.08
302.490.0080



2.
00994



3.
00992
071.555.075.502



4.
00971
81.97420.0139
1801.337.00
81.97420.0152



Horizontal
LHD
Standard

Series N 414

Type



N 414

Front pipe

Silencer

Tail pipe

28790
307.490.0219

Left hand side



28747
307.490.0068



28746
307.490.0119



28587
307.490.1601



28319
307.490.5021



28748
307.490.0319

Right hand side



28747
307.490.0068



Mounting Parts

1.
00294



2.
00238



3.
28078
001.987.5340



4.
28450
305.492.0182



5.
28072
442.492.0280



Horizontal
LHD
Standard

Series SKYLINER

Type

Euro I



N1 16
N 217

OM 402
12,8l tr.
8 cyl.
176 KW/240 HP
188 KW/256 HP

OM 422
14,6l tr.
8 cyl.
184 KW/250 HP
206 KW/280 HP

OM 403
16,0l tr.
10 cyl.
235 KW/320 HP
264 KW/360 HP

Front pipe

Silencer

Tail pipe

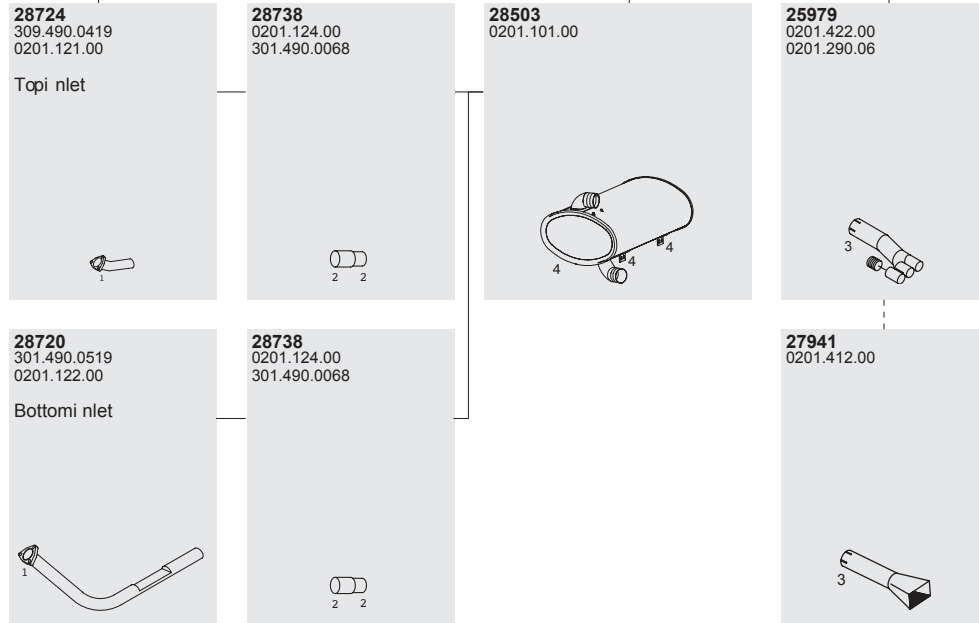

Mounting Parts

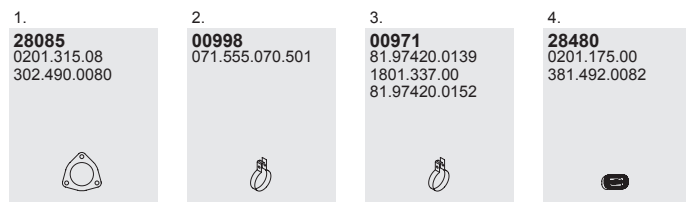

Horizontal
LHD
Standard

Series SKYLINER

Type



N 122

OM 422 A
14,6l tr.
8 cyl.
243 KW/330 HP

OM 442 A
14,6l tr.
8 cyl.
250 KW/340 HP

OM 403 A
16,0l tr.
10 cyl.
264 KW/360 HP

Front pipe

26669
300.490.0119
0201.152.00



27721
300.492.0059
0201.16.00



26661
300.490.0219
0201.164.00



Silencer

28177
300.490.0001
0201.151.00

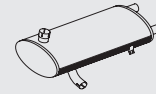

Tail pipe

N.A.

0201.419.00

26662
0201.161.01
300.490.0519
300.490.0319



26663
300.490.0619



27721
300.492.0059
0201.16.00



26662
0201.161.01
300.490.0519
300.490.0319



26667
300.490.0419

OM 403 A



Mounting Parts

1.
28075
11006118



2.
00901
1801.348.00
1801.315.00



Horizontal
LHD
Standard

Series STARLINER

Type

Euro III
09/96 →



④X②
⑥X②/④

N 516 SHD/H
(07/01)
N 516/3 SHD/H

D2866 LOH23
12,0l tr.
6 cyl.
294 KW/400 HP

D2876 LOH01
13,0l tr.
6 cyl.
338 KW/460 HP

Front pipe

10607
11006854



22786
11006884



10619
11000944



22785
11006882

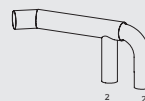

Silencer

22587
11006710

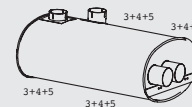

Tail pipe

22385
11006837



Mounting Parts

1.
00948
11006057



2.
00981
1801.407.00
11032405



3.
28084
11006116



4.
28417
0201.137.00
11006071



5.
28418
11006070
0201.136.00
0201.136.00



6.
00978
11032354



Horizontal
LHD/RHD
Standard

Series STARLINER

Type

Euro III
09/96 →



④X②
⑥X②/④

N 516 SHD/H
(07/01)
N 516/3 SHD/H

OM 502 LA
16,0l tr.
8 cyl.
350 KW/476 HP

Front pipe

Silencer

Tail pipe

27762
11006858



22787
11006823



22587
11006710



22385
11006837



27762
11006858



22788
11006820



Mounting Parts

1.
28410
11006974



2.
00981
1801.407.00
11032405



3.
28084
11006116



4.
28417
0201.137.00
11006071



5.
28418
11006070
0201.136.00
0201.136.00



6.
00978
11032354



Horizontal
LHD/RHD
Standard

Series STARLINER

Type

Euro III
04/04 →



P12N 5218 SHD

D2876 LOH20
13,0l tr.
6 cyl.
353 KW/480 HP

Front pipe

Silencer

Tail pipe

14763
81.15205.5009

AEM



14681
81.15205.5015

AEM



10599
81.15101.0341
81.15101.0293

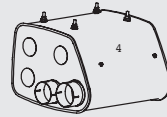

19957
81.15205.5034
81.15205.5010

INOX

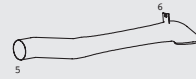

Mounting Parts

1.
19471
88.98105.0010



2.
10050
88.97445.0015



3. → 25/02
00971
81.97420.0139
1801.337.00
81.97420.0152



3. 25/02 →
19447
88.15640.0007
88.15640.2203



4.
10493
81.15110.0296

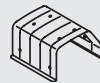

5.
10073
81.97420.5045



6.
10454
81.96210.0101



Horizontal
LHD/RHD
Standard

Series TOURLINER

Type

Euro III

17/02 →



P21N 2216 SHD

✎ **D2866 LOH**
12,0l tr.
6 cyl.
228 KW/310 HP
265 KW/360 HP
310 KW/410 HP

✎ **D2876 LOH**
13,0l tr.
6 cyl.
338 KW/460 HP

20/02 →





P22N 2216/3
SHD/L

✎ **D2876 LOH**
13,0l tr.
6 cyl.
338 KW/460 HP





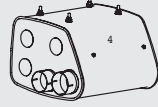
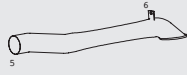

Front pipe

Silencer

Tail pipe

<p>14763 81.15205.5009</p> <p>AEM</p> 	<p>14681 81.15205.5015</p> <p>AEM</p> 	<p>10599 81.15101.0341 81.15101.0293</p> 	<p>19957 81.15205.5034 81.15205.5010</p> <p>INOX</p> 
--	--	--	---

Mounting Parts

<p>1. 19471 88.98105.0010</p> 	<p>2. 10050 88.97445.0015</p> 	<p>3. → 25/02 00971 81.97420.0139 1801.337.00 81.97420.0152</p> 	<p>3. 25/02 → 19447 88.15640.0007 88.15640.2203</p> 	<p>4. 10493 81.15110.0296</p> 	<p>5. 10073 81.97420.5045</p> 	<p>6. 10454 81.96210.0101</p> 
--	--	--	--	--	--	--

Horizontal
LHD/RHD
Standard

Series TRANSLINER

Type

Euro I
12/88 →



N 316

OM 401
9,6l tr.
6 cyl.
141 KW/192 HP

OM 441 LA
11,0 ltr.
6 cyl.
200 KW/272 HP
230 KW/313 HP
250 KW/340 HP

Front pipe

27762
11006858



27763
621.492.0008



Silencer

28152
356.490.0201
356.490.0101

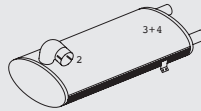

Tail pipe

N.A.

0201.419.00

Mounting Parts

1.
28410
11006974



2.
28073
625.492.0040



3. x3
28084
11006116



4.
28007



Horizontal
LHD
Standard

RENAULT

Agora 383

C 935 384

ER 100 385

FR1 387

FRH 388

GX 187 (Heuliez) 390

GX 317 (Heuliez) 392

Iliade 393

Megabus 394

PER 180 395

PR 100 396

PR 112 400

PR 118 402

PR 180 404

R 312 406

Recreo 407

Recreo (Karosa) 408

S 45 409

S 53 411

S 105 413

Tracer 415

Series AGORA

Type

Euro III
01/96 →



MIDR
06.20.45 I41
9,8l tr.
6 cyl.
188 KW/256 HP

Front pipe

31640
5000951507



31644
5010155615



31607
5010198805



31649
5010198868
5010155772



Silencer

31514
5000778162

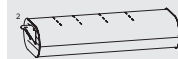

Tail pipe

31356
5010200355



Mounting Parts

1.
00772
5010140898
0000798219
5010317399



2.
31456
5010366795



3.
31457
5010202775



Horizontal
LHD
Standard

Series C 935

Type

Euro III
1997 → 2002



Karosa

MIDR
06.20.45 A41
9,8l tr.
6 cyl.
188 KW/256 HP

F2BE1682G
7,8l tr.
6 cyl.
243 KW/330 HP

Front pipe

31600
5001839447



31604
5001839445



31609
5001839444



Silencer

31546
5001839442

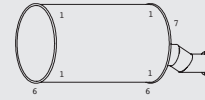

Tail pipe

31545
5001839449



Mounting Parts

1.
48010
5001840597



2.
31070
5001843006



3.
31067
5001843007



4.
31068
5001843008



5.
31459
5001840439



6.
31453
5001839453



7.
31076
0000704037



Horizontal
LHD
Standard

Series ER 100

Type

Euro I



4X2

Silencer

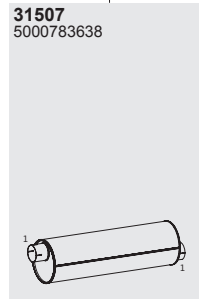

Tail pipe

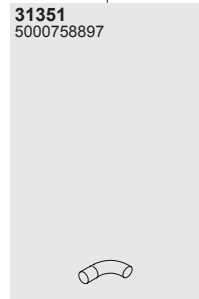

Mounting Parts

1.
00784
5010317140
5010317148
5000472319



Horizontal
LHD
Standard

Series ER 100

Type

Euro I
06/93 →



Front pipe

31640
5000951507



31756
5010007560



Silencer

31507
5000783638



Tail pipe

31305
5010017039



Mounting Parts

1.
31457
5010202775



2.
00784
5010317140
5010317148
5000472319



Horizontal
LHD
Standard

Series FR 1

Type

Euro II



4X2

Front pipeT

Silencer

ail pipe

31615
5000952836

→ 12/93



31528
5000951504

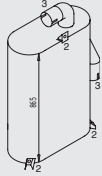

31391
5000954073

→ 04/91

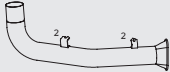

31691
5010179180

01/94 →



31695
5010265293

01/94 →



31395
5010173193

05/91 → 12/93



31353
5010174606

05/91 →



31352
5010265530

01/94 →



Mounting Parts

1.
31076
0000704037



2.
31074
5000954034



3.
00772
5010140898
0000798219
5010317399



Horizontal
LHD
Standard

Series FRH

Type

Euro II



4X2

Front pipeT

Silencer

ail pipe

31615
5000952836

→ 12/93



31528
5000951504

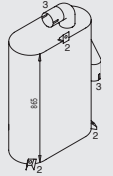

31391
5000954073

→ 04/91



31691
5010179180

01/94 →



31695
5010265293

01/94 →



31395
5010173193

05/91 → 12/93

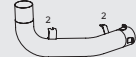

31353
5010174606

05/91 →



31352
5010265530

01/94 →



Mounting Parts

1.
31076
0000704037



2.
31074
5000954034



3.
00772
5010140898
0000798219
5010317399



Horizontal
LHD
Standard

Series FRH

Type

Euro II
01/97 →



Front pipe

Silencer

Tail pipe

31691
5010179180

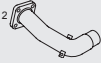

31694
5010265957



31595
5010305159

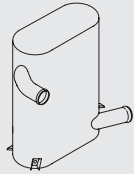

31334
5010286639

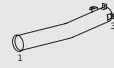

31353
5010174606



Mounting Parts

1.
31079
5001838015



2.
31076
0000704037



3.
31074
5000954034



4.
00772
5010140898
0000798219
5010317399



Horizontal
LHD
Standard

Series GX 187 (HEULIEZ)

Type

Euro II



Silencer

31507
5000783638

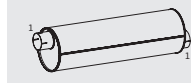

Tail pipe

31355
5000782719



Mounting Parts

1.
00784
5010317140
5010317148
5000472319



Horizontal
LHD
Standard

Series GX 187 (HEULIEZ)

Type

Euro II
06/93 →



Front pipe

31640
5000951507



31756
5010007560



Silencer

31507
5000783638



Tail pipe

31305
5010017039



Mounting Parts

1.
31457
5010202775



2.
00784
5010317140
5010317148
5000472319



Horizontal
LHD
Standard

Series GX 317 (HEULIEZ)

Type

Euro III
1994 → 2002



MIDR
06.20.45 F41
9,8l tr.
6 cyl.
152 KW/207 HP

MIDR
06.20.45 I41
9,8l tr.
6 cyl.
188 KW/256 HP

Front pipe

31640
5000951507



31644
5010155615



31607
5010198805



31649
5010198868
5010155772



Silencer

31514
5000778162

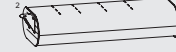

Tail pipe

31356
5010200355



Mounting Parts

1.
00772
5010140898
0000798219
5010317399



2.
31456
5010366795



3.
31457
5010202775



Horizontal
LHD
Standard

Series ILIADE

Type

Euro II
01/97 →



Front pipe

Silencer

Tail pipe

31691
5010179180



31694
5010265957



31595
5010305159

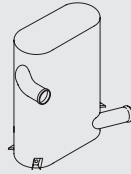

31334
5010286639

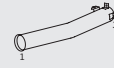

31353
5010174606



Mounting Parts

1.
31079
5001838015



2.
31076
0000704037



3.
31074
5000954034



4.
00772
5010140898
0000798219
5010317399



Horizontal
LHD
Standard

Series MEGABUS

Type

Euro II



Front pipe

31640
5000951507



31756
5010007560



Silencer

31507
5000783638

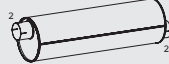

Tail pipe

31305
5010017039



Mounting Parts

1.
31457
5010202775



2.
00784
5010317140
5010317148
5000472319



Horizontal
LHD
Standard

Series PER 180

Type

Euro I



Silencer

Tail pipe

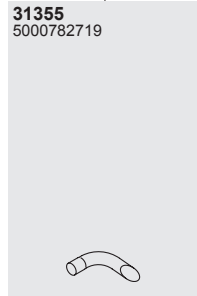
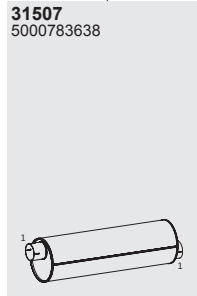

Mounting Parts

1.
00784
5010317140
5010317148
5000472319



Horizontal
LHD
Standard

Series PR 100

Type

Euro I



4X2

Silencer

Tail pipe

31507
5000783638



31351
5000758897



Mounting Parts

1.

00784
5010317140
5010317148
5000472319



Horizontal
LHD
Standard

Series PR 100

Type

Euro II
06/93 →



PR 100
Mark II

Front pipe

Silencer

Tail pipe

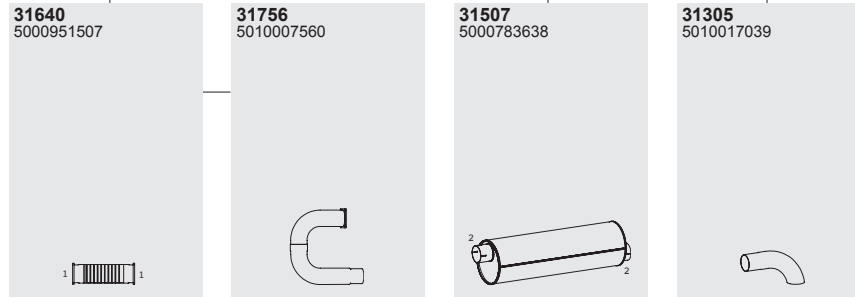

Mounting Parts

1.
31457
5010202775

2.
00784
5010317140
5010317148
5000472319

Horizontal
LHD
Standard

Series PR 100

Type

Euro II



4X2

PR 100
Mark III

Front pipe

31640
5000951507

31756
5010007560

Silencer

31507
5000783638

Tail pipe

31305
5010017039

Mounting Parts

1.
31457
5010202775

2.
00784
5010317140
5010317148
5000472319

Horizontal
LHD
Standard

Series PR 100

Type

Euro II
06/96 →



PR 100-3

Front pipe

Silencer

31640
5000951507



31716
5010307917



31115
5010322466



Mounting Parts

1.
31457
5010202775



2.
31079
5001838015



3.
31414
5010322037



Horizontal
LHD
Standard

Series PR 112

Type

Euro II



4X2

Front pipe

Silencer

Tail pipe

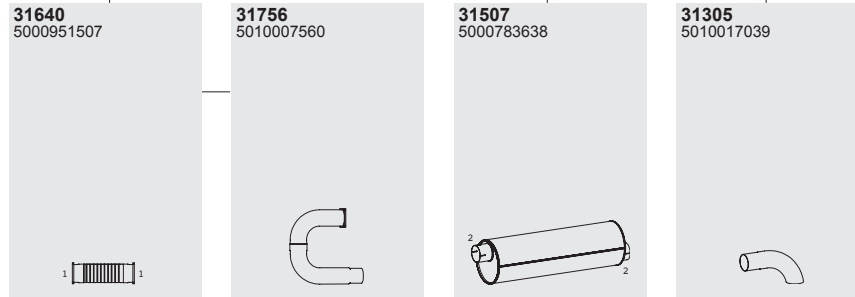

Mounting Parts

1.
31457
 5010202775



2.
00784
 5010317140
 5010317148
 5000472319



Horizontal
 LHD
 Standard

Series PR 112

Type

Euro II
06/96 →



Front pipe

Silencer

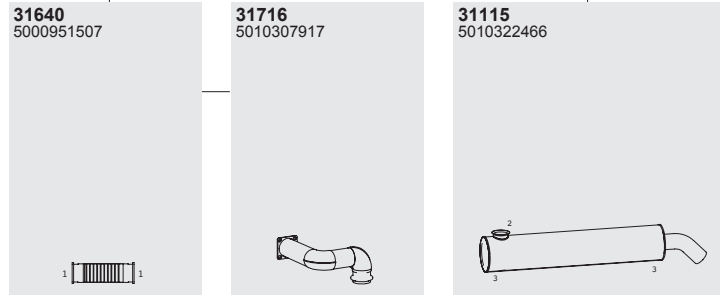

Mounting Parts

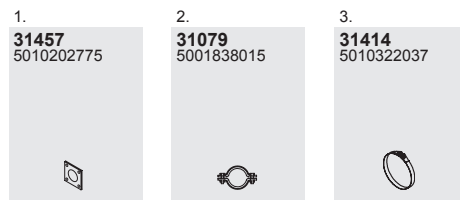

Horizontal
LHD
Standard

Series PR 118

Type

Euro II



Front pipe

Silencer

Tail pipe

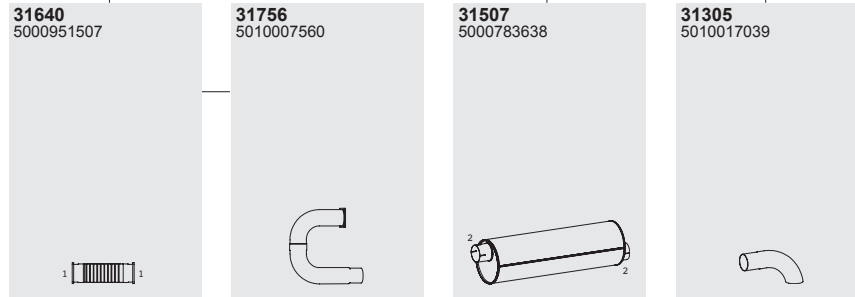

Mounting Parts

1.
31457
 5010202775



2.
00784
 5010317140
 5010317148
 5000472319



Horizontal
 LHD
 Standard

Series PR 118

Type

Euro II
06/96 →



Front pipe

Silencer

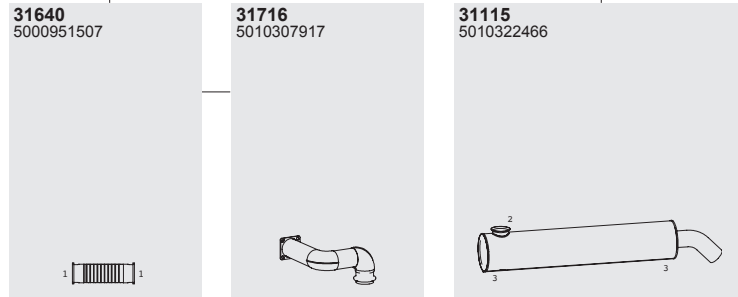

Mounting Parts

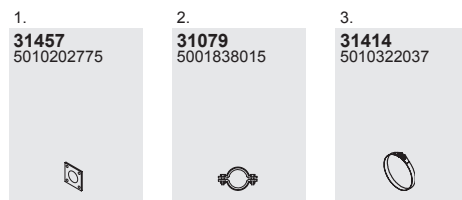

Horizontal
LHD
Standard

Series PR 180

Type

Euro II



©X2

PR 180-2

Silencer

31507
5000783638

Tail pipe

31355
5000782719

Mounting Parts

1.

00784
5010317140
5010317148
5000472319Horizontal
LHD
Standard

Series PR 180

Type

Euro I
06/93 →



PR 180-2

Front pipe

31640
5000951507



31756
5010007560



Silencer

31507
5000783638

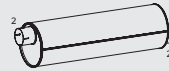

Tail pipe

31305
5010017039



Mounting Parts

1.
31457
5010202775



2.
00784
5010317140
5010317148
5000472319



Horizontal
LHD
Standard

Series R 312

Type

Euro I
07/93 →



Front pipe

31640
5000951507



31644
5010155615



31643
5010155771
8162322



31649
5010198868
5010155772



Silencer

31514
5000778162



Tail pipe

31356
5010200355



Mounting Parts

1.
00772
5010140898
0000798219
5010317399



2.
31456
5010366795



3.
31457
5010202775



Horizontal
LHD
Standard

Series **RECREO**

Type

Euro III
1999 →



F2BE1682G
7,8l tr.
6 cyl.
243 KW/330 HP

Front pipe

31708
5801114539



31263
5010475496



31269
5801114554



Silencer

64177
580117292

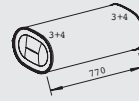

Tail pipe

31939
5801114570

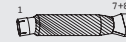

Mounting Parts

1.
00788
5010377343
5801117293



2.
00784
5010317140
5010317148
5000472319



3.
31494
5006005896



4.
31490
5006005895



5.
00803
5003083065
5010317400
5801117294



7.
31493
5801114567



8.
31499
5801114565



Horizontal
LHD
Standard

Series RECREO (KAROSA)

Type

Euro III
1997 → 2002



MIDR
06.20.45 A41
9,8l tr.
6 cyl.
188 KW/256 HP

F2BE1682G
7,8l tr.
6 cyl.
243 KW/330 HP

Front pipe

31600
5001839447



31604
5001839445



31609
5001839444



Silencer

31546
5001839442

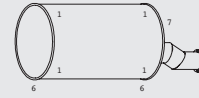

Tail pipe

31545
5001839449

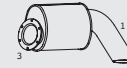

Mounting Parts

1.
48010
5001840597



2.
31070
5001843006



3.
31067
5001843007



4.
31068
5001843008



5.
31459
5001840439



6.
31453
5001839453



7.
31076
0000704037



Horizontal
LHD
Standard

Series S 45

Type



Front pipe

31717
5000488273



Silencer

31116
5000488302

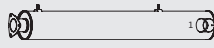

Tail pipe

31303
5000925029

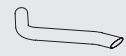

Mounting Parts

1.
00849
5000544353
0035665142



2.
31455
5010072871



Horizontal
LHD
Standard

Series S 45

Type



Front pipe

Silencer

Tail pipe

31648
5000927068



31117
5000882896

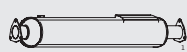

31647
5000925732



31300
5000927072

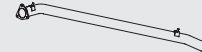

Mounting Parts

1.

31455
5010072871



Horizontal
LHD
Standard

Series S 53

Type



Front pipe

31717
5000488273



Silencer

31116
5000488302

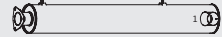

Tail pipe

31303
5000925029

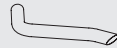

Mounting Parts

1.
00849
5000544353
0035665142



2.
31455
5010072871



Horizontal
LHD
Standard

Series S 53

Type



Front pipe

Silencer

Tail pipe

31648
5000927068



31117
5000882896

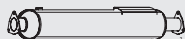

31647
5000925732



31646
5000927074

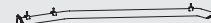

Mounting Parts

1.
31455
5010072871



Horizontal
LHD
Standard

Series S 105

Type



Front pipe

31717
5000488273



Silencer

31116
5000488302



Tail pipe

31303
5000925029

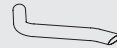

Mounting Parts

1.
00849
5000544353
0035665142



2.
31455
5010072871



Horizontal
LHD
Standard

Series S 105

Type



Front pipe

Silencer

Tail pipe

31648
5000927068



31117
5000882896

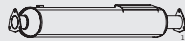

31309
5000927066



31304
5000927070



Mounting Parts

1.
31455
5010072871



Horizontal
LHD
Standard

Series TRACER

Type

Euro II



MIHR
06.20.45 A41
 9,8l tr.
 6 cyl.
 185 KW/252 HP

MIHS
06.20.45 A
 9,8l tr.
 6 cyl.
 190 KW/255 HP

Front pipe

Silencer

Tail pipe

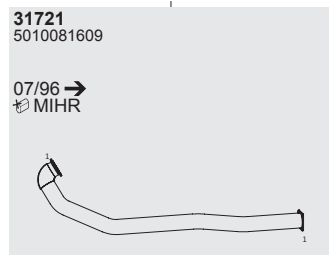
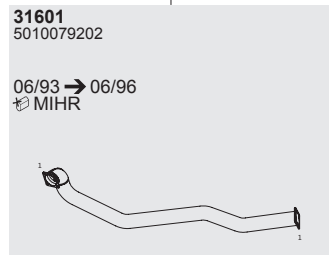
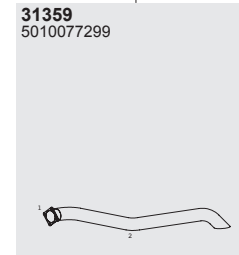
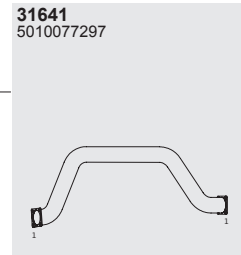
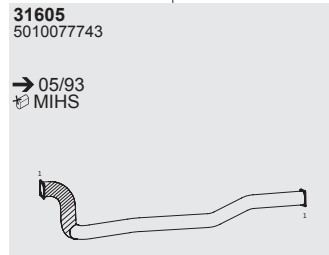

Mounting Parts

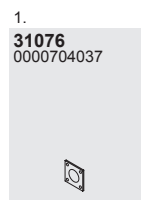

Horizontal
 LHD
 Standard

SOYLU / OTOBÜS

SCANIA

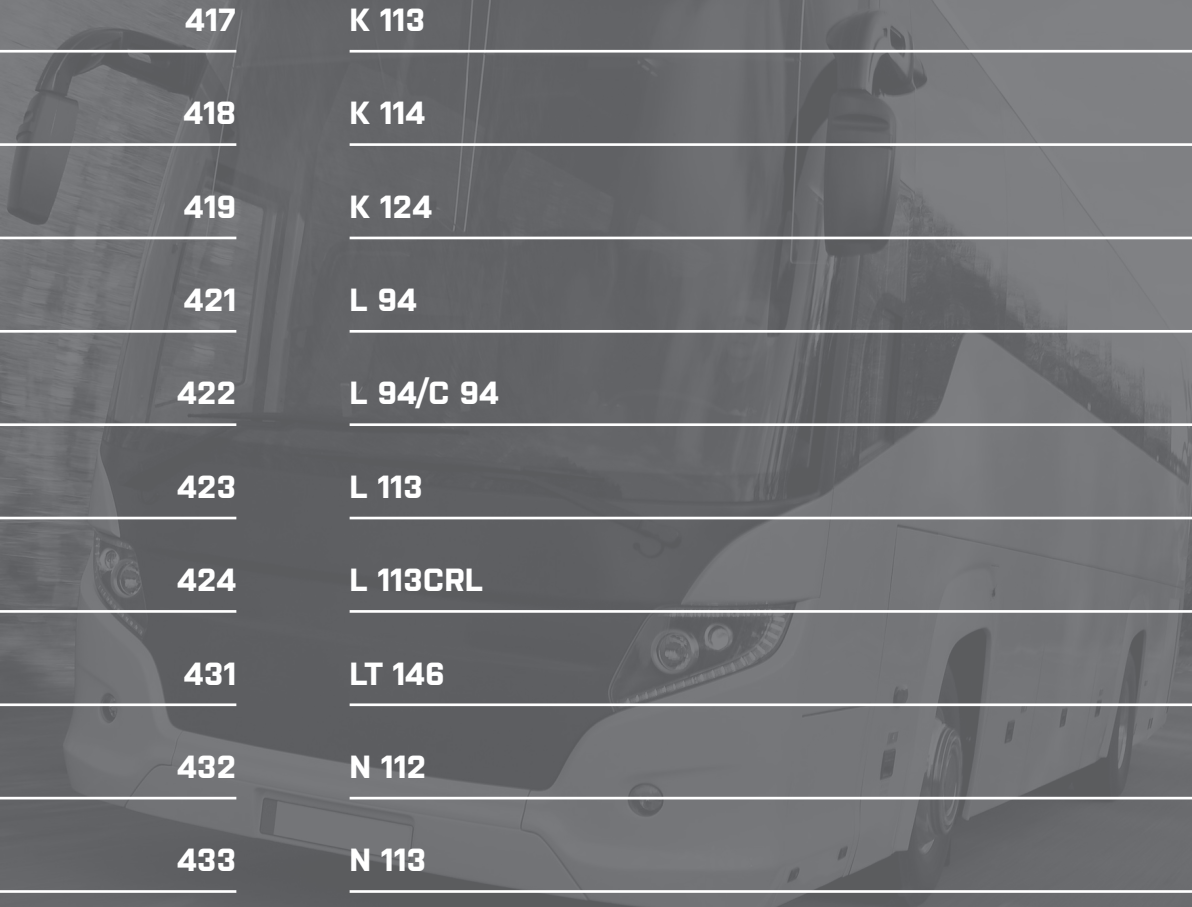

BR 85/86	417	K 113	436
BR 110	418	K 114	443
BR 112	419	K 124	444
BR 116	421	L 94	445
BR 145	422	L 94/C 94	446
CR 112	423	L 113	447
DAB/SCANIA/DENMARK	424	L 113CRL	448
K 82	431	LT 146	449
K 92	432	N 112	450
K 93	433	N 113	451
K 94	434	NR 112	453
K 112	435	Omnicity	454

Series BR 85/86

Type



Silencer

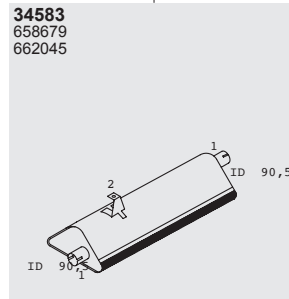

Mounting Parts

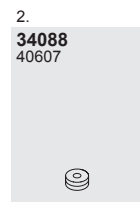
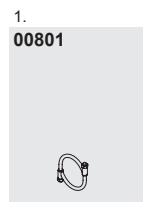

Horizontal
LHD
Standard

Series BR 110

Type



Silencer

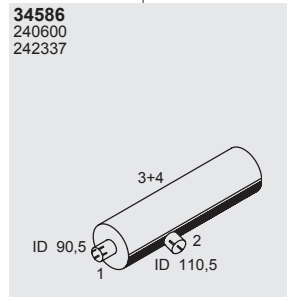

Mounting Parts

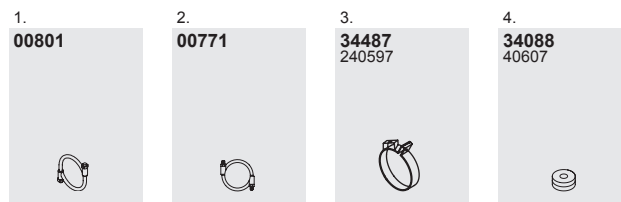

Horizontal
LHD
Standard

Series BR 112

Type

1980 → 1988



4X2

Front pipe

Silencer

Tail pipe

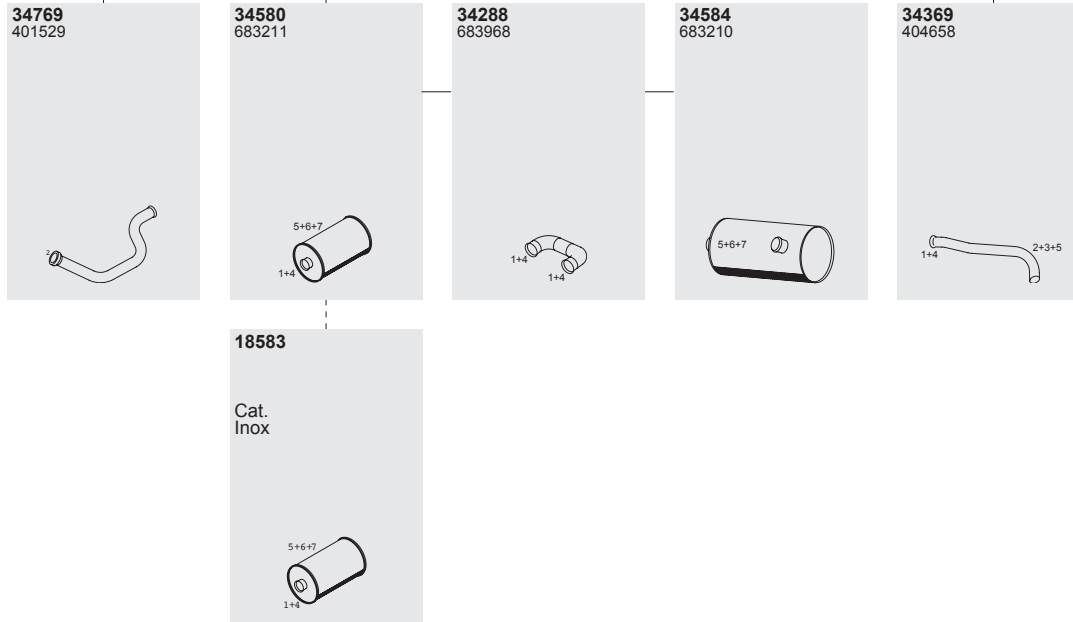

Mounting Parts

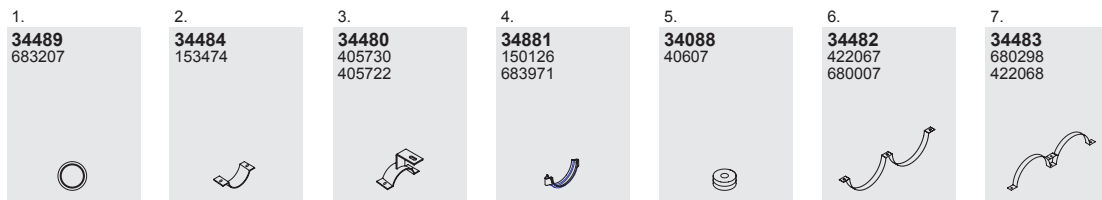

Horizontal
LHD
Standard

Series BR 112

Type

1980 → 1988



Front pipe

Silencer

Tail pipe

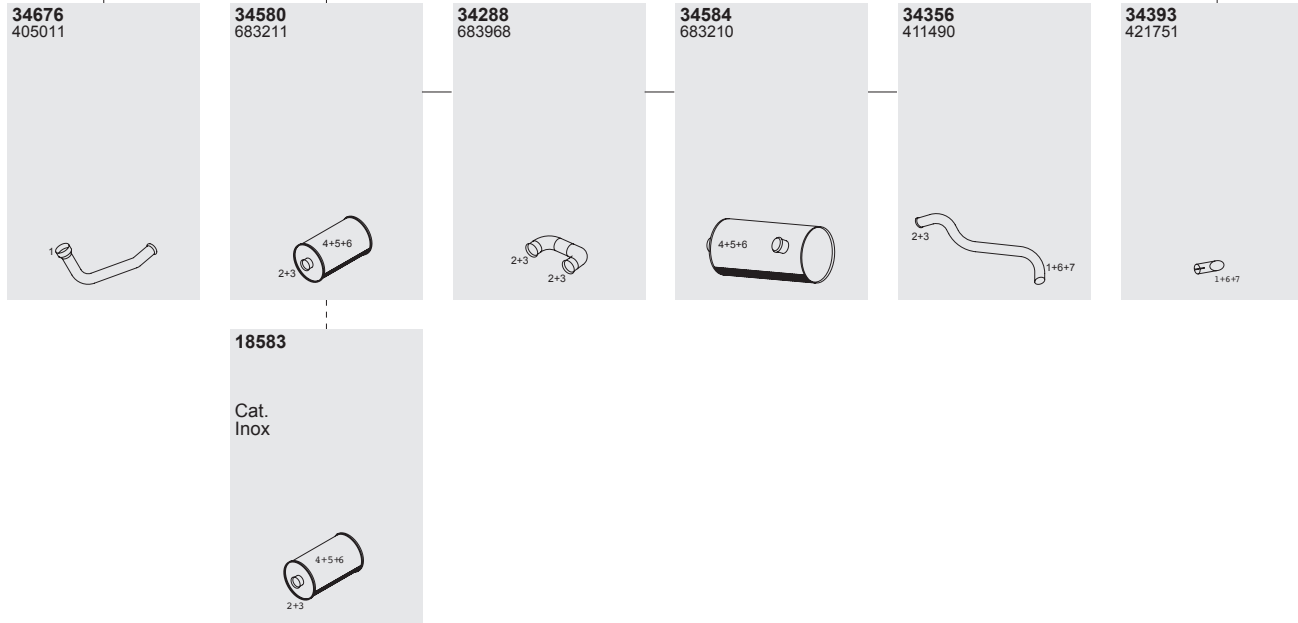

Mounting Parts

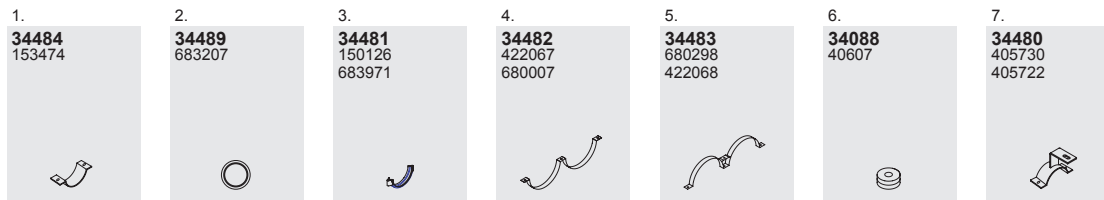

Horizontal
LHD
Standard

Series BR 116

Type



Silencer

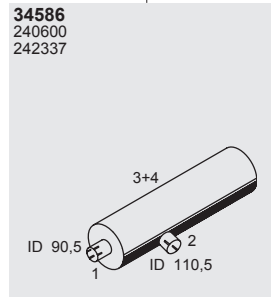

Mounting Parts

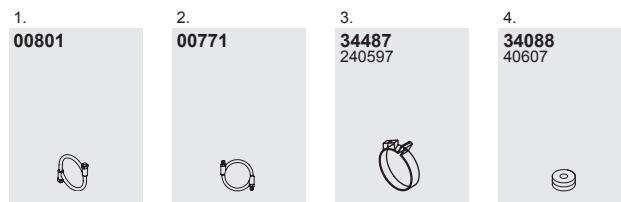

Horizontal
LHD
Standard

Series BR 145

Type



Silencer

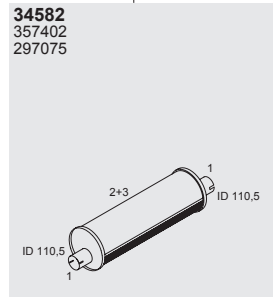

Mounting Parts

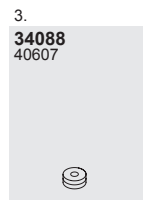
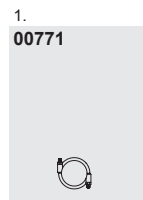

Horizontal
LHD
Standard

Series CR 112

Type

1978 → 1987



4X2

Front pipe

34769
401529

Silencer

34580
683211

34288
683968

34584
683210

Tail pipe

34369
404658

18583
Cat.
Inox

Mounting Parts

1.
34489
683207

2.
34484
153474

3.
34480
405730
405722

4.
34481
150126
683971

5.
34088
40607

6.
34482
422067
680007

7.
34483
680298
422068

Horizontal
LHD
Standard

Series DAB/SCANIA, DENMARK

Type



Silencer

11587

680
→ 03/78

11586

490, 04/78 →
Series 7, → 1987

67585

Series 7, 1987 → 1989

Ø 101,6

Horizontal
LHD
Standard

Series DAB/SCANIA, DENMARK

Type

Euro I



4X2

Series 15 MKI

Front pipe

Silencer

Tail pipe

40699



40507

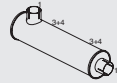

40690



48722



40649



40507

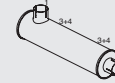

07844



Mounting Parts

1.
00801



2.
00640T



3.
04683



4.
48010



Horizontal
LHD
Standard

Series DAB/SCANIA, DENMARK

Type



Service bus

Front pipe

Silencer

Tail pipe

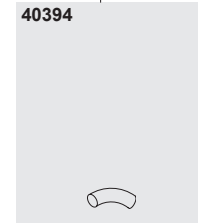
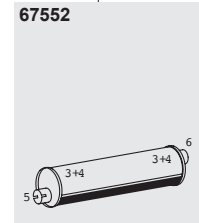
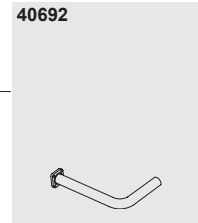
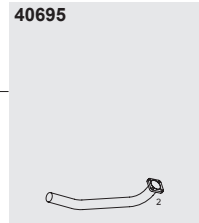
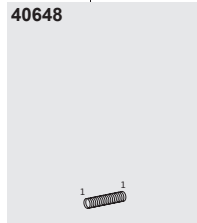

Mounting Parts

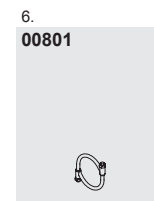
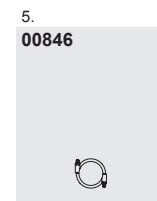
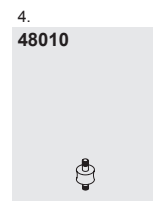
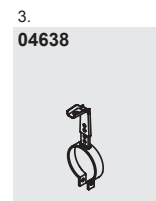
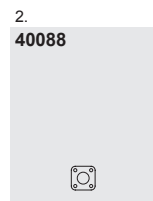
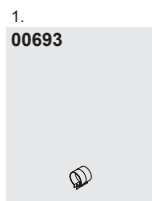

Horizontal
LHD
Standard

Series DAB/SCANIA, DENMARK

Type

Euro I



4X2

Series 15 MKII

Front pipeT

Silencer

ail pipe

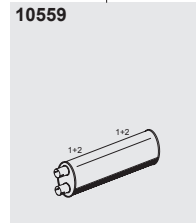
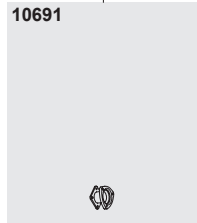

Mounting Parts

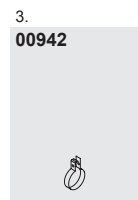
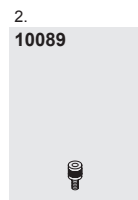
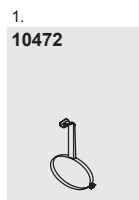

Horizontal
LHD
Standard

Series DAB/SCANIA, DENMARK

Type

Euro I



4X2

Series 15 MKIII

Diesel engine

Front pipe

Silencer

Tail pipe

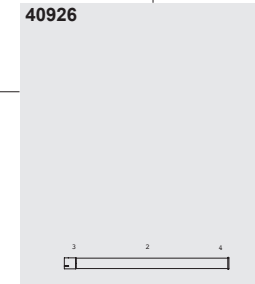
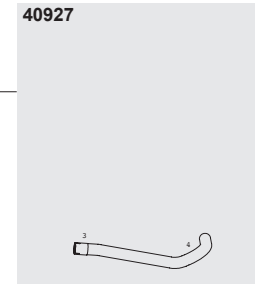
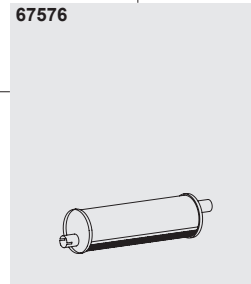
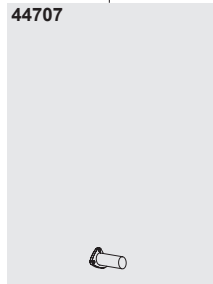

Mounting Parts

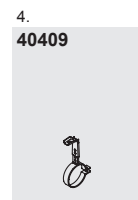
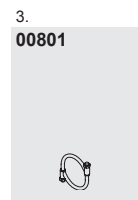
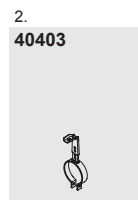
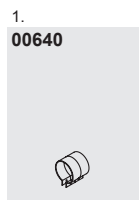

Horizontal
LHD
Standard

Series DAB/SCANIA, DENMARK

Type

Euro I



4X2

Series 15 MKIII

LPG engine
(Liquid Petrol Gas)

Front pipe

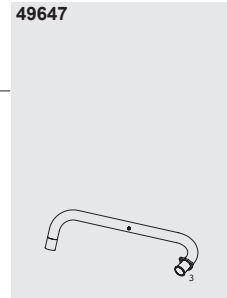
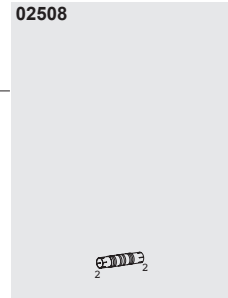
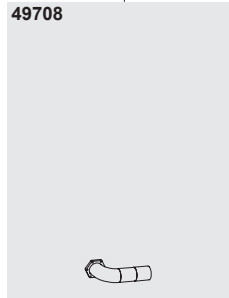

Silencer

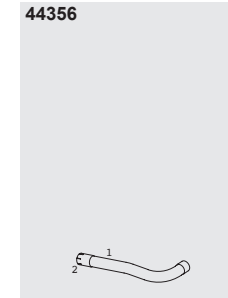
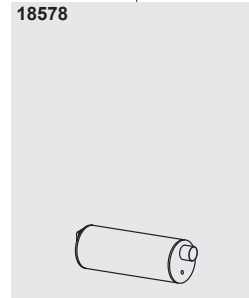

Tail pipe

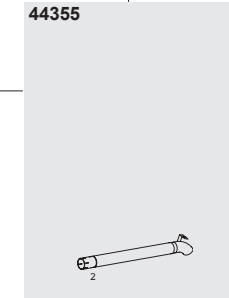

Mounting Parts

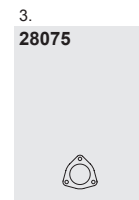
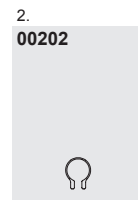
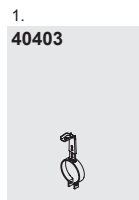

Horizontal
LHD
Standard

Series DAB/SCANIA, DENMARK

Type

Euro II



Series 12

Front pipe

Silencer

Tail pipe

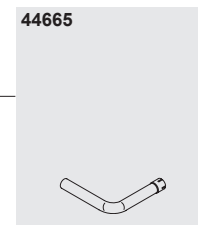
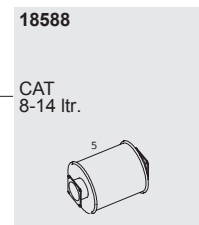
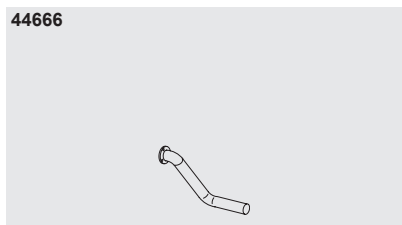
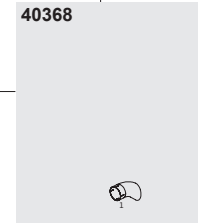
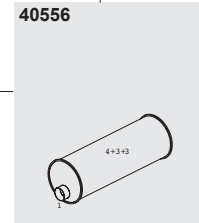
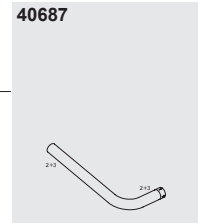
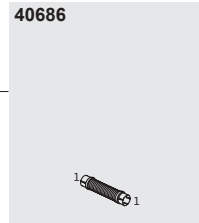

Mounting Parts

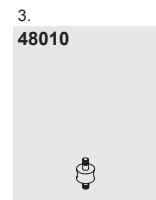
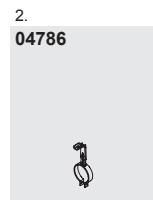

Horizontal
LHD
Standard

Series K 82

Type

Euro I
1982 → 1992



DSI 8.01L
7,8l tr.
6 cyl.
126 KW/171 HP

Front pipeT

34713
416734
377225

GA762, GS771, GS772

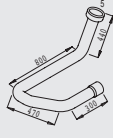

Silencer

34582
357402
297075

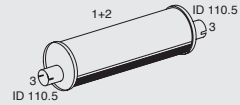

ail pipe

34339
411767



18582

CAT

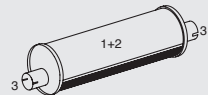

34350
424156



Mounting Parts

1.
34488
249970



2.
34088
40607



3.
00771



3. Alternative
34474
328928
1384745



4.
34476
411770



5.
34484
153474



Horizontal
LHD
Standard

Series K 92

Type

Euro I
1982 → 1992



DS 9.03L
8,5l tr.
6 cyl.
132 KW/179 HP

DS 9.03
8,5l tr.
6 cyl.
177 KW/241 HP

Front pipeT

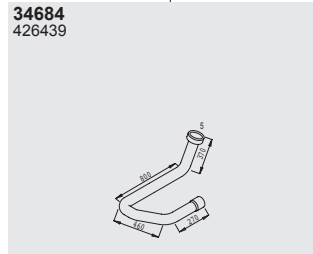

Silencer

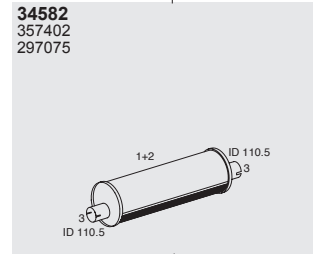

ail pipe

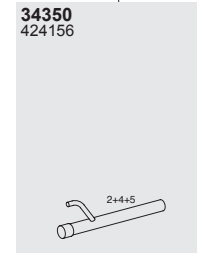
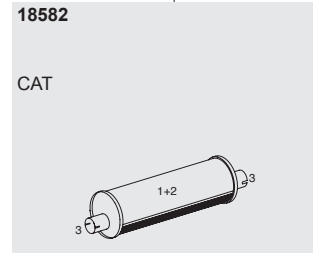
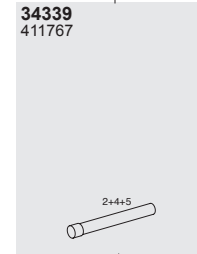

Mounting Parts

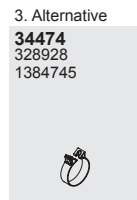
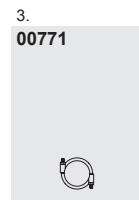
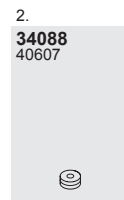
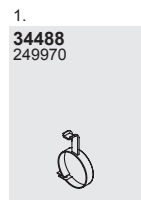

Horizontal
LHD
Standard

Series K 93

Type

Euro II
1992 → 1997



DS 9.03L
8,5l tr.
6 cyl.
132 KW/179 HP

DS 9.03
8,5l tr.
6 cyl.
177 KW/241 HP

Front pipe

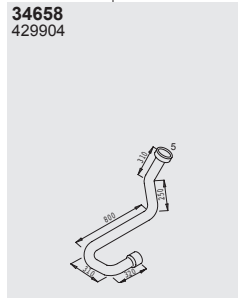

Silencer

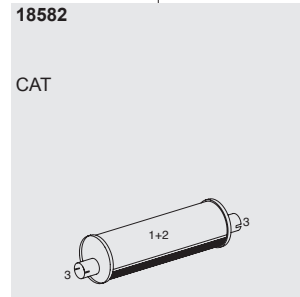
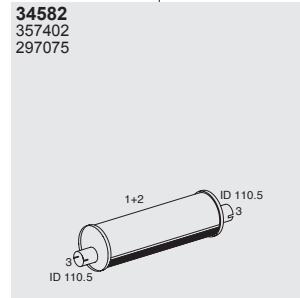

Mounting Parts

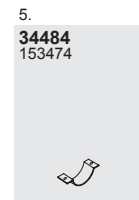
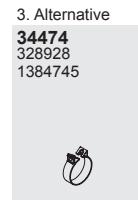
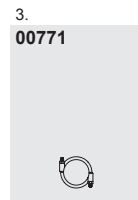
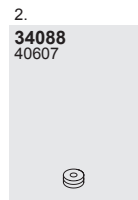
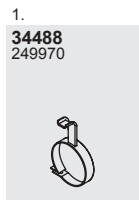

Horizontal
LHD
Standard

Series K 94

Type

Euro III
1997 → 2004



DC 9.01
9,0l tr.
6 cyl.
169 KW/230 HP

DC 9.02
9,0l tr.
6 cyl.
191 KW/260 HP

DSC 9.15
9,0l tr.
6 cyl.
228 KW/310 HP

Front pipe

34650
1428892
1364355



34618
1364290



34624
475830



Silencer

34569
1420278
1378553
1500455

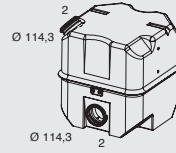

Tail pipe

34929
473993
1430747

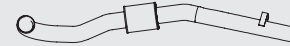

34924
485455
1430617



34271
1435067

RH

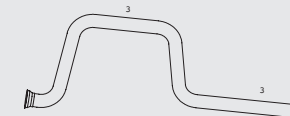

Mounting Parts

1.

34453
1360294



2.

34452
1335618
1422474
1387136



3.

34484
153474



Horizontal
LHD
Standard

Series K 112

Type

Euro I
1985 → 1992



④X②
⑥X②

☞ D1 1.15
11,0 ltr.
6 cyl.
206 KW/305 HP

Front pipes

ilencer

Tail pipe

34713
416734
377225

☞ G776, GS771, GS772

34582
357402
297075

34339
411767

34677
429919

☞ GA771, GA771-R

18582

CAT

34350
424156

34678
420140

☞ GA762, GA762-R

Mounting Parts

1.
34488
249970

2.
34088
40607

3.
00771

3. Alternative
34474
328928
1384745

4.
34476
411770

5.
34484
153474

Horizontal
LHD
Standard

Series K 113

Type

Euro II
1992 → 1997



④X②
⑥X②

K1 13TLA

DSC 11.13
11,0 ltr.
6 cyl.
267 KW/363 HP

►CHno 1823425

Front pipe

Silencer

Tail pipe

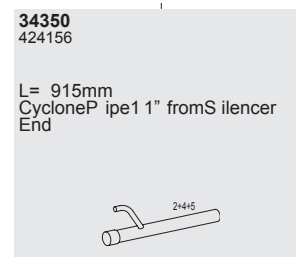
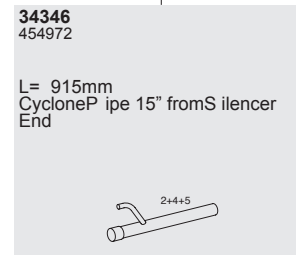
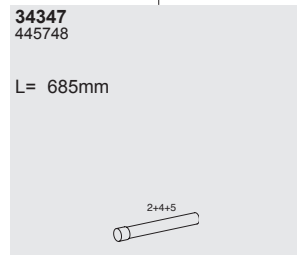
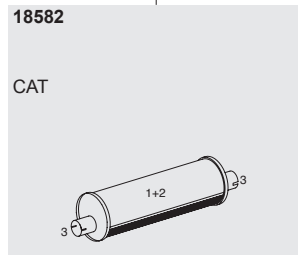
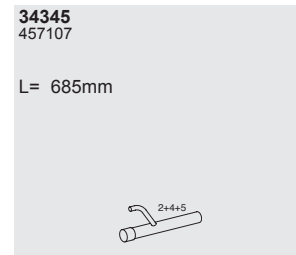
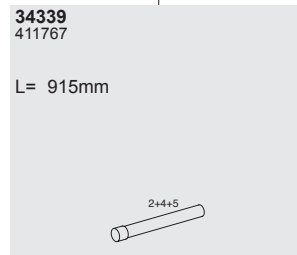
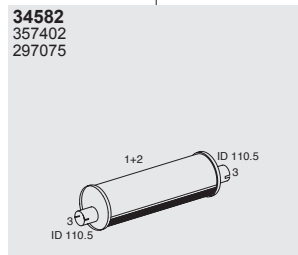
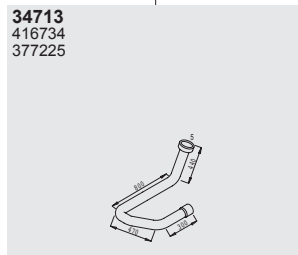

Mounting Parts

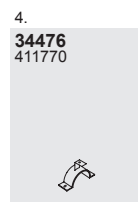
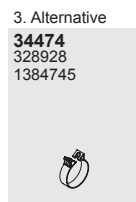
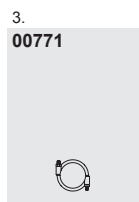
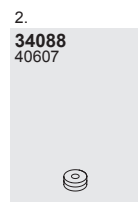
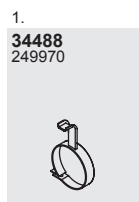

Horizontal
LHD
Standard

Series K 113

Type

Euro II
1992 → 1997



K113TLB

DS 11.34
11,0 ltr.
6 cyl.
228 KW/310 HP

DS 11.73
11,0 ltr.
6 cyl.
230 KW/313 HP

DSC 11.13
11,0 ltr.
6 cyl.
267 KW/363 HP

DSC 11.18
11,0 ltr.
6 cyl.
267 KW/363 HP

►CHno 1823425

Front pipeT

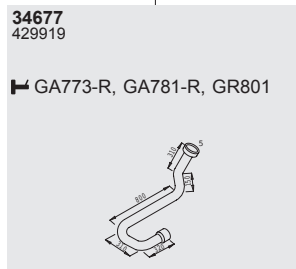
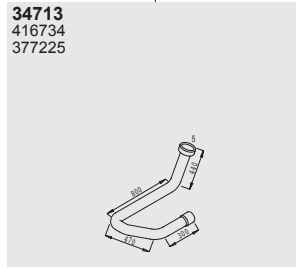

Silencer

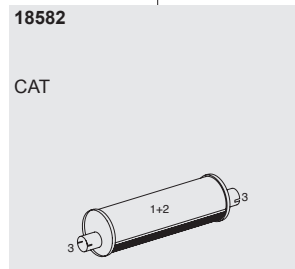
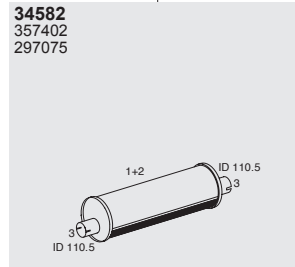

ail pipe

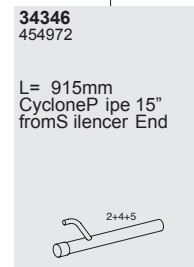
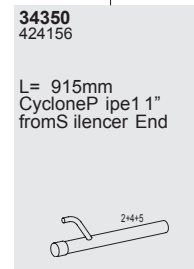
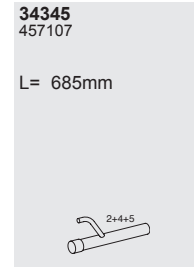
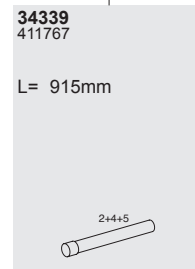
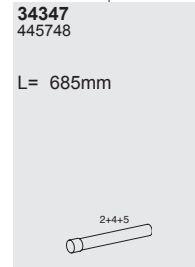

Mounting Parts

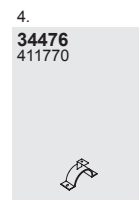
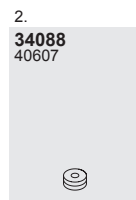
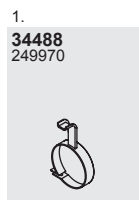

Horizontal
LHD
Standard

Series K 113

Type

Euro II
1992 → 1997



K1 13CLB

DS 11.34
11,0 ltr.
6 cyl.
228 KW/310 HP

DS 11.73
11,0 ltr.
6 cyl.
230 KW/313 HP

DSC 11.13
11,0 ltr.
6 cyl.
267 KW/363HP

DSC 11.18
11,0 ltr.
6 cyl.
267 KW/363 HP

►CHno 1823425

Front pipe



Silencer

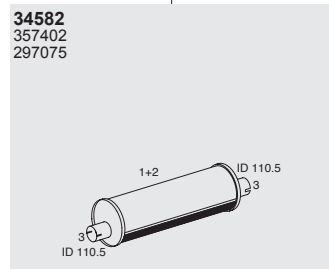

Tail pipe

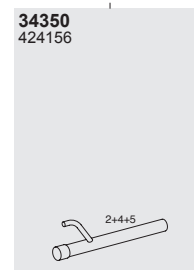
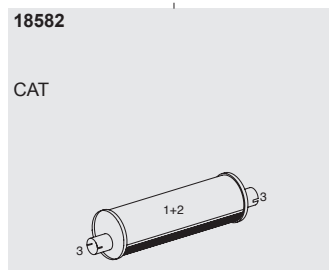

Mounting Parts

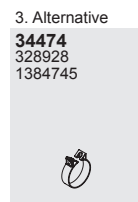
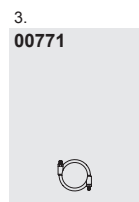
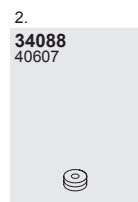
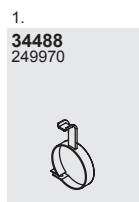

Horizontal
LHD
Standard

Series K 113

Type

Euro II
1992 → 1997



K1 13TRB

DS 11.34
11,0 ltr.
6 cyl.
228 KW/310 HP

DSC 11.21
11,0 ltr.
6 cyl.
235 KW/320 HP

DSC 11.23
11,0 ltr.
6 cyl.
266 KW/362 HP

DSC 11.22
11,0 ltr.
6 cyl.
280 KW/381 HP

►CHno1823425

Front pipe

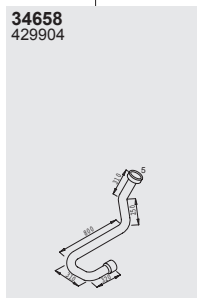

Silencer

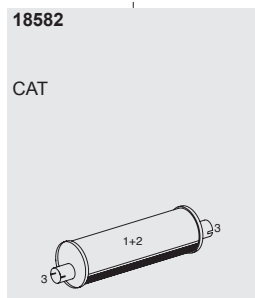
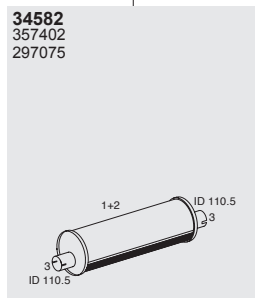

Mounting Parts

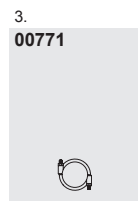
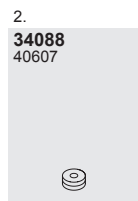
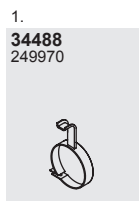

Horizontal
LHD
Standard

Series K 113

Type

Euro II
1992 → 1997



K1 13 CRB

DC 11.34
11,0 ltr.
6 cyl.
228 KW/310 HP

DSC 11.21
11,0 ltr.
6cyl.
235 KW/320 HP

DSC 11.23
11,0 ltr.
6 cyl.
266 KW/362 HP

DSC 11.22
11,0 ltr.
6 cyl.
280 KW/381 HP

►CHno 1823425

Front pipe

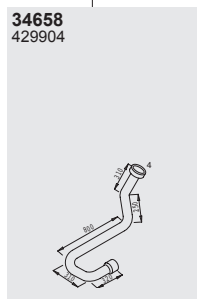

Silencer

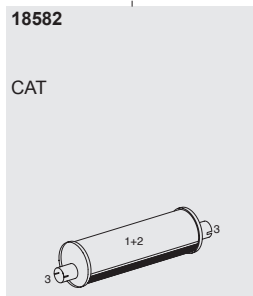
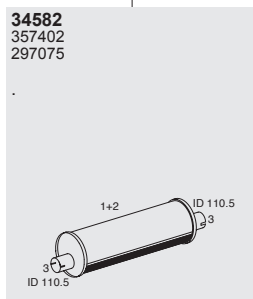

Mounting Parts

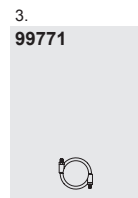
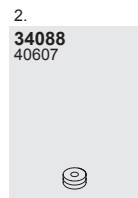
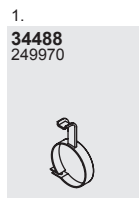

Horizontal
LHD
Standard

Series K 113

Type

Euro II
1992 → 1997



K1 13

DC 11.34
11,0 ltr.
6 cyl.
228 KW/310 HP

DC 12.01
11,7 ltr.
6 cyl.
309 KW/420 HP

1823426 ▶CHno

Front pipe

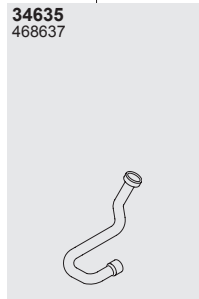

Silencer

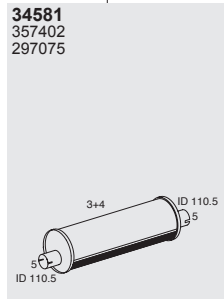

Tail pipe

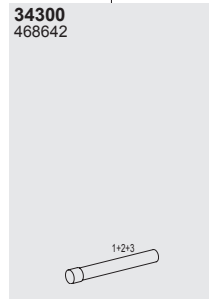

Mounting Parts

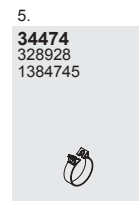
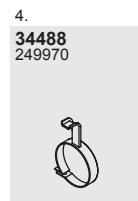
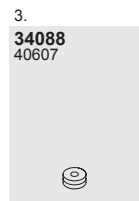
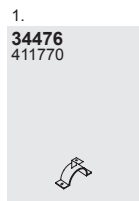

Horizontal
LHD
Standard

Series K 113

Type

Euro II
1992 → 1997



④X②
⑥X②

K1 13

DC 11.23
11,0 ltr.
6 cyl.
265 KW/360 HP

1825186-SBK
▶CHno

Front pipe

34633
475929

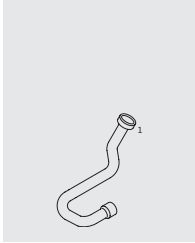

Silencer

34565
1305509
1338160
1361983

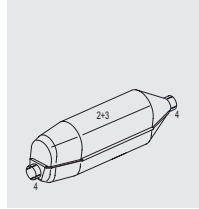

Tail pipe

34981
475930

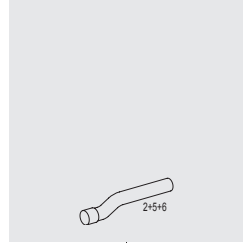

34982
475931

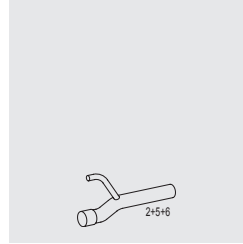

Mounting Parts

1.

34484
153474



2.

34088
40607

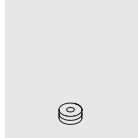

3.

34410
472941



4.

34470
1300367

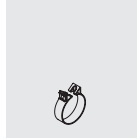

5.

34477
1114180
207550
1114182



6.

34458
481654
461135



Horizontal
LHD
Standard

Series K 114

Type

Euro III
1997 → 2004



④X②
⑥X②

K1 14
Irizar Century

✎ DC 11.03
✎ DC 11.04
✎ DC 11.06
✎ DC 11.07
10,6l tr.
6 cyl.
243 KW/330 HP
250 KW/340 HP
280K W/381H P

Front pipe

34650
1428892
1364355



34618
1364290



34620
475829
488700



Silencer

34569
1420278
1378553
1500455

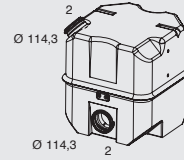

Tail pipe

34924
485455
1430617



34929
473993
1430747

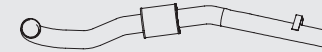

Mounting Parts

1.

34453
1360294



2.

34452
1335618
1422474
1387136



Horizontal
LHD
Standard

Series K 124

Type

Euro III
1997 → 2004



④X②
⑥X②

☞ **DSC 12.02**
☞ **DSC 12.05**
11,7 ltr.
6 cyl.
265 KW/360 HP
309 KW/420 HP

☞ **DC 12.01**
☞ **DC 12.02**
☞ **DC 12.09**
11,7 ltr.
6 cyl.
265 KW/360 HP
309 KW/420 HP

Front pipe

34650
1428892
1364355



346118
1364290



34620
475829
488700



Silencer

34569
1420278
1378553
1500455

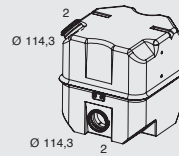

Tail pipe

34929
473993
1430747



34924
485455
1430617

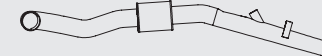

Mounting Parts

1.

34453
1360294



2.

34452
1335618
1422474
1387136



Horizontal
LHD
Standard

Series L 94

Type

Euro III
1997 → 2004



④X②
⑥X②
⑥X②/②

☞ **DSC 9.11**
☞ **DSC 9.12**
☞ **DSC 9.13**
☞ **DSC 9.15**
9,0l tr.
6 cyl.
162 KW/220 HP
191 KW/260 HP
228 KW/310 HP

☞ **DC 9.01**
☞ **DC 9.02**
☞ **DC 9.03**
☞ **DC 9.04**
☞ **DC 9.05**
☞ **DC 9.06**
9,0l tr.
6 cyl.
169 KW/230 HP
191 KW/260 HP
221 KW/300 HP

Front pipe

34650
1428892
1364355

34618
1364290

34638
473990

Silencer

34569
1420278
1378553
1500455

Tail pipe

34929
473993
1430747

34924
485455
1430617

34271
1435067
RH

34354
1439104

Mounting Parts

1.
34453
1360294

2.
34452
1335618
1422474
1387136

3.
34484
153474

4.
000482

Horizontal
LHD
Standard

Series L94/CL94

Type

Euro III



L94
CL94

DSC9.11
9,0l tr.
6 cyl.
162 KW/220 HP

DSC9.12
9,0l tr.
6 cyl.
191 KW/260 HP

DSI9E 01
9,0l tr.
6 cyl.
169 KW/230 HP

DC9.01
9,0l tr.
6 cyl.
169 KW/230 HP

DC9.02
9,0l tr.
6 cyl.
191 KW/260 HP

OSC9 G01
9,0l tr.
6 cyl.
191 KW/260 HP

Horizontal
LHD/RHD
Standard

Front pipe

34650
1428892
1364355



34618
1364290



39678
1453950



Silencer

34579
1448427

DPF



Tail pipe

34966
1465085

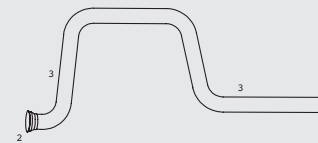

Mounting Parts

1.

34453
1360294



2.

34452
1335618
1422474
1387136



3.

34484
153474



Series L 113

Type

Euro II
1992 → 1997



L 133CRL

DSC 11.08
11,0 ltr.
6 cyl.
218 KW/310 HP

1820167 ▶CHno

Front pipe

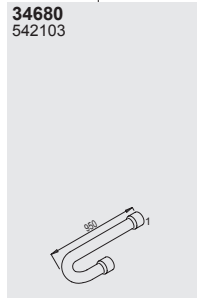

Silencer

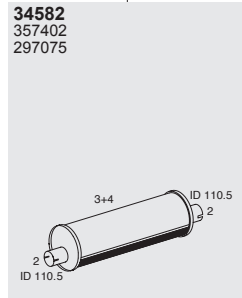

Tail pipe

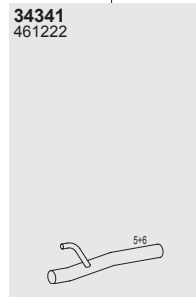
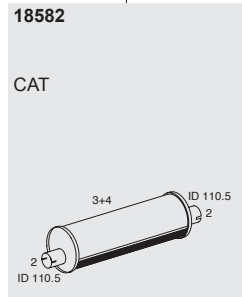
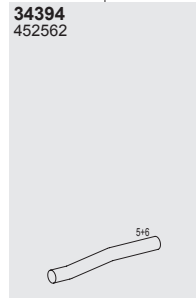

Mounting Parts

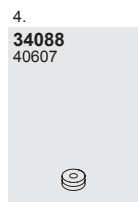
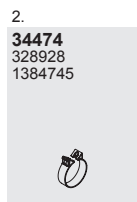
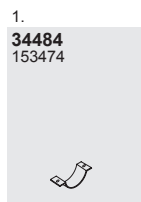

Horizontal
LHD
Standard

Series L 113CRL

Type

Euro II
1992 → 1997



L1 13CRL

DSC 11.24
11,0 ltr.
6 cyl.
191 kW/260 HP

Front pipe

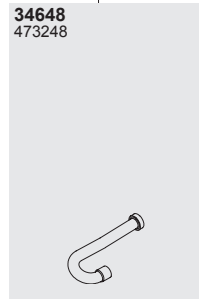

Silencer

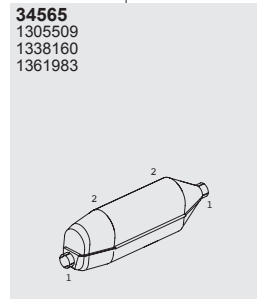

Tail pipe

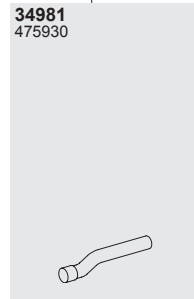

Mounting Parts

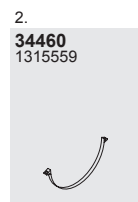
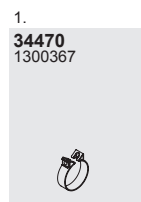

Horizontal
LHD
Standard

Series LT 146

Type

LT 146

Silencer

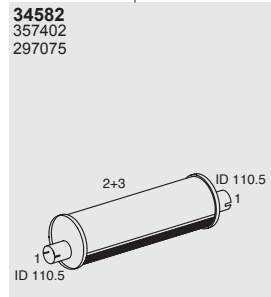

Mounting Parts

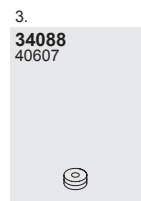
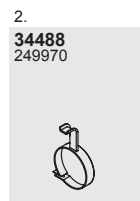
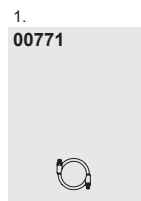

Horizontal
LHD
Standard

Series N 112

Type

Euro I



N1 12CL

Front pipe

Silencer

Tail pipe

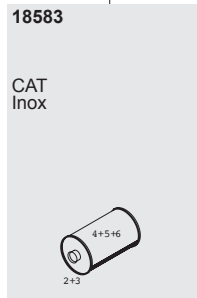
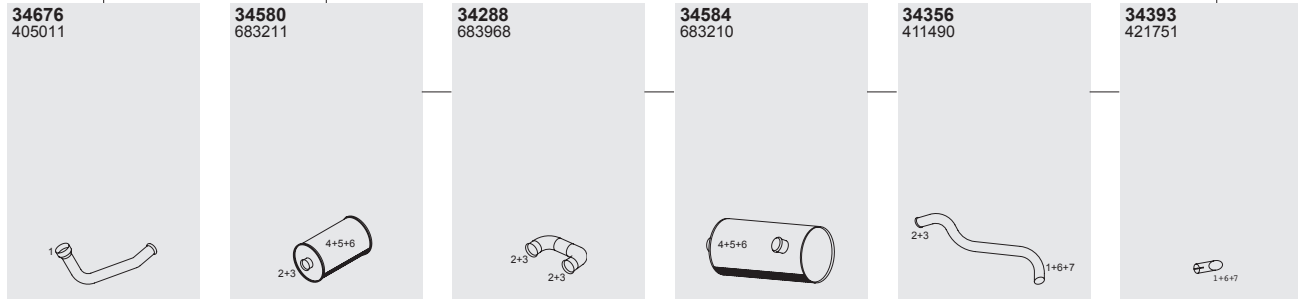

Mounting Parts

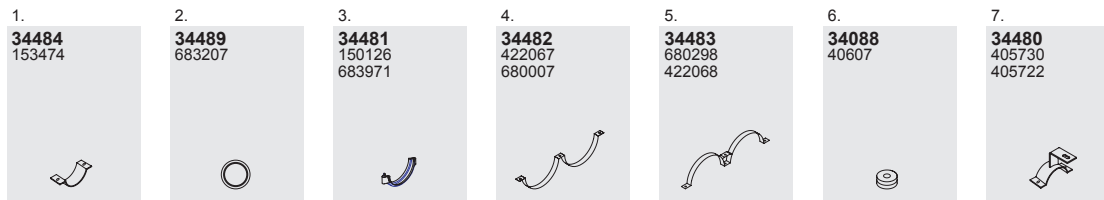

Horizontal
LHD
Standard

Series N 113

Type

Euro II



N1 13ALB

DSC 11.27
11,0 ltr.
6 cyl.
176 KW/250 HP

DSC 11.08
11,0 ltr.
6 cyl.
250 KW/340 HP

1820118 ▶CHno

Front pipe

34676
405011

Silencer

34580
683211

34288
683968

34584
683210

Tail pipe

34356
411490

ChassisW idth
2500mm

18583

CAT
Inox

34390
460891

ChassisW idth
2600mm

Mounting Parts

1.
34484
153474

2.
34489
683207

3.
34481
150126
683971

4.
34482
422067
680007

5.
34483
680298
422068

6.
34088
40607

7.
34480
405730
405722

8.
34463
445250

Horizontal
LHD
Standard

Series N 113

Type

Euro II



N1 13CLB

DSC 11.27
11,0 ltr.
6 cyl.
176 KW/250 HP

1820118 ▶CHno

Front pipe

Silencer

Tail pipe

34676
405011

34580
683211

34288
683968

34584
683210

34356
411490

ChassisW idth
2500mm

18583

CAT
Inox

34390
460891

ChassisW idth
2600mm

Mounting Parts

1.
34484
153474

2.
34489
683207

3.
34481
150126
683971

4.
34482
422067
680007

5.
34483
680298
422068

6.
34088
40607

7.
34480
405730
405722

8.
34463
445250

Horizontal
LHD
Standard

Series NR 112

Type

Euro I



4X2

NR 112

Front pipe

Silencer

Tail pipe

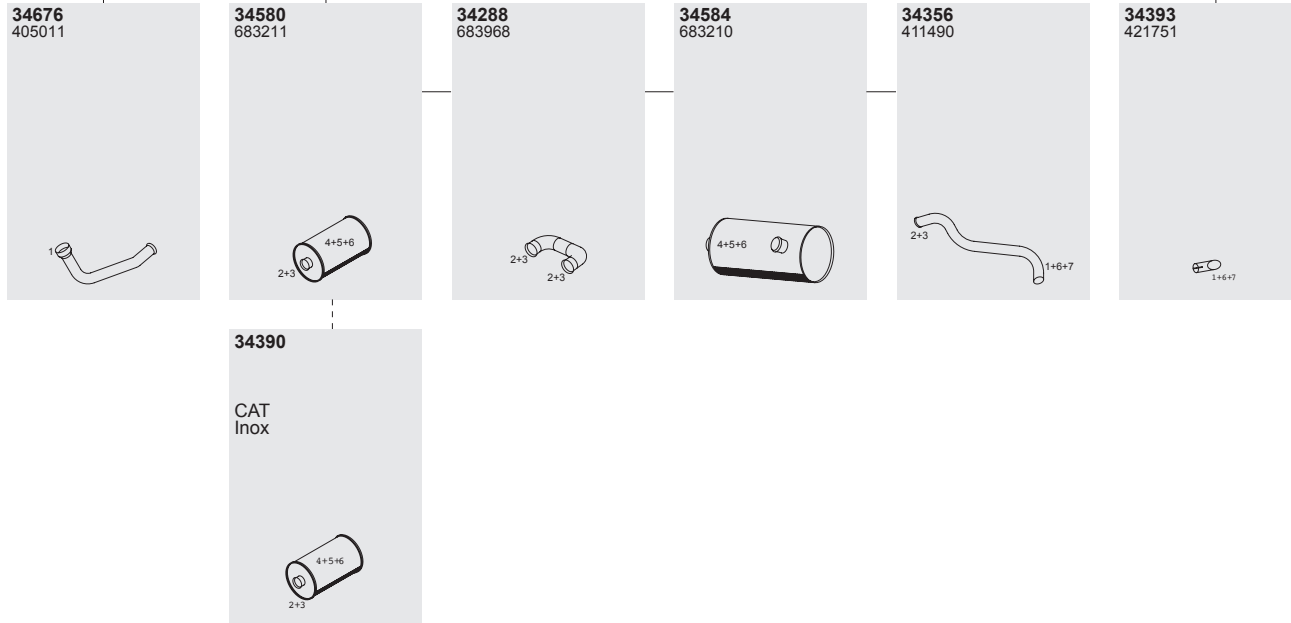

Mounting Parts

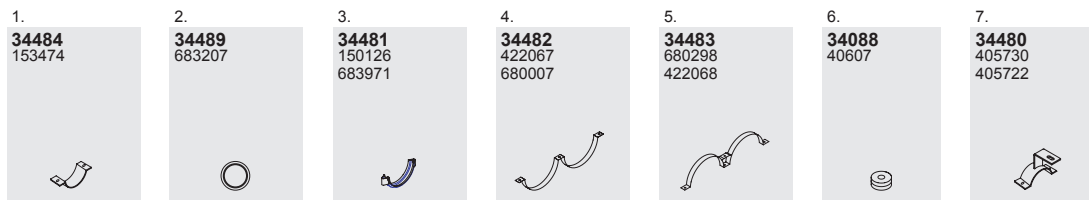

Horizontal
LHD
Standard

Series OMNICITY

Type

Euro III



DSC 9.11
 DSC 9.12
 DSI 9.E01
 9,0l tr.
 6 cyl.
 162 KW/220 HP
 191 KW/260 HP
 169 KW/230 HP

DC 9.01
 DC 9.02
 DC 9.04
 DC 9.05
 8,9l tr.
 6 cyl.
 169 KW/230 HP
 191 KW/260 HP

Horizontal
 LHD
 Standard

Front pipe

34650
1428892
1364355

34618
1364290

34636
488166

Silencer

34557
475145

34285
486669

34279
1433304

With tail pipe
68726

34556
1427528

Inox

34281
1427529

Inox

34555
488575

34551
489798

Inox

Tail pipe

34309
486668
1747250

34963
1500100

34304
1427530
1747249

Inox

Mounting Parts

1.
34489
683207

2.
34411
488864

3.
34414
488866

4.
34412
478769

5.
34413
478772

6.
34452
1335618
1422474
1387136

7.
34415
488862

8.
34416
478759

9. x2
34453
1360294

10. x2
34481
150126
683971

11.
34484
153474

12.
34463
445250

13.
34419
474119

SOYLU / OTOBÜS

SETRA



S 200

456

S 300

475

S 400

488

Series S200

Type



S209
S210
S211
S212

OM 401
9,6l tr.
6 cyl.
141 KW/192 HP

OM 421
11,0 ltr.
6 cyl.
159 KW/216 HP

Silencer

30587
179-34.10.000-05B

This silencer is delivered with mounting traps (69800 + 69801)

Mounting Parts

1.
30488
179-34.00.180-04

2.
30487
139-34.00.115.04

Horizontal
LHD
Standard

Series S200

Type



OM 402
12,8l tr.
8 cyl.
188 KW/256 HP

OM 422
14,6l tr.
8 cyl.
206 KW/280 HP

OM 403
15,9l tr.
10 cyl.
236 KW/320 HP

Horizontal
LHD
Standard

Silencer

30588
179-34.10.000-10B
179-34.10.000-04B
6091242
This silencer is delivered with
mountings traps (69800 +
69801)

Mounting Parts

1.
30488
179-34.00.180-04

2.
30487
139-34.00.115.04

Series S200

Type

Euro I



S209
S210
S211
S213
S214
S215
S216

OM 422 A/LA
14,7l tr.
8. cyl.
243 KW/330 HP
270 KW/375 HP

System Mounted
Lefto fE ngine

Horizontal
LHD
Standard

Front pipe

Silencer

Tail pipe

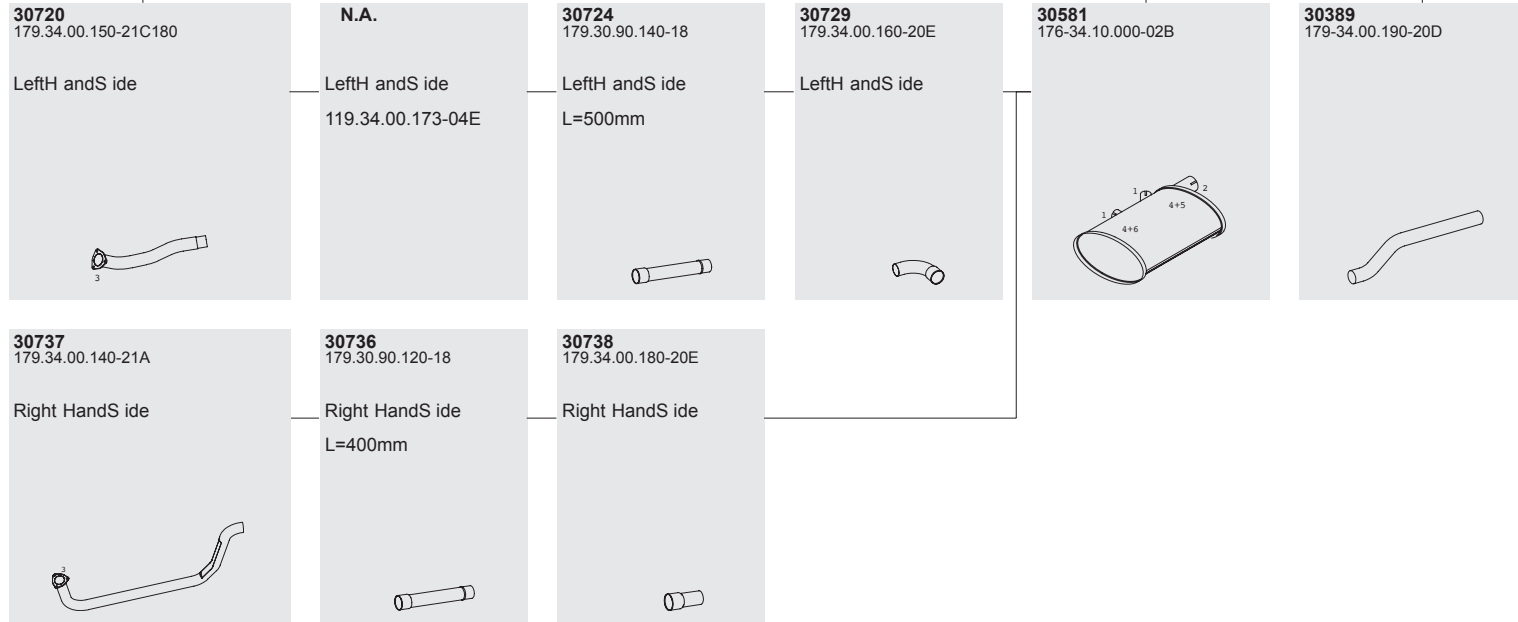

Mounting Parts

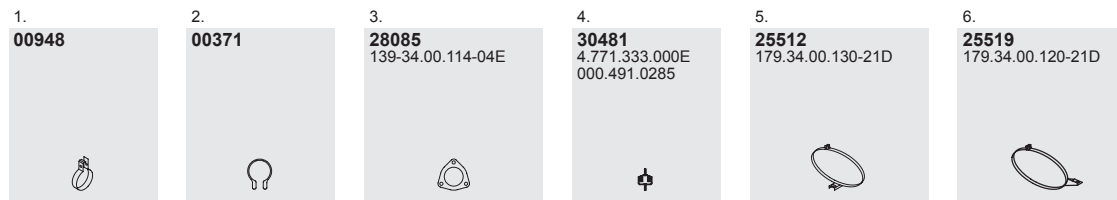

Series S200

Type

Euro I



S210

OM 421

11,0 ltr.

6 cyl.

159 KW/216 HP

System Mounted
Right Engine

Front pipe

30785
179-34.00.120-28A
174-34.00.130-01B

30781
179-34.00.130-26B

30782
174-34.00.150-01A

Silencer

30584
174-34.10.000-01

30385
175-34.00.140-03C

30385
175-34.00.140-03C

Tail pipe

30387
8.341.000.076D
8.341.000.191

30387
8.341.000.076D
8.341.000.191

Mounting Parts

1.
28085
139-34.00.114-04E

2.
30485
179-34.00.162-26E

3.
00994

4.
00948

5.
30481
4.771.333.000E
000.491.0285

6.
30482
139-34.00.170-09D
139-34.00.180-09C
139-34.00.160-09D

7.
30489
179-34.00.120-25D

Horizontal
LHD
Standard

Series S200

Type

Euro I



S211

OM 421
11,0 ltr.
6 cyl.
159 KW/216 HP

System Mounted
Right of Engine

Front pipe

30783
174-34.00.120-04A
175-34.00.120-04A

30781
179-34.00.130-26B

30789
175-34.00.130-04A

Silencer

30582
179-34.10.000-15B

Tail pipe

30385
175-34.00.140-03C

30385
175-34.00.140-03C

30387
8.341.000.076D
8.341.000.191

30387
8.341.000.076D
8.341.000.191

Mounting Parts

1.
28085
139-34.00.114-04E

2.
30485
179-34.00.162-26E

3.
00994

4.
00948

5.
30481
4.771.333.000E
000.491.0285

6.
30482
139-34.00.170-09D
139-34.00.180-09C
139-34.00.160-09D

7.
30489
179-34.00.120-25D

Horizontal
LHD
Standard

Series S200

Type

Euro I



S211

OM 422

14,7l tr.
8 cyl.
243 KW/330 HP

Front pipe

Silencer

Tail pipe

30783
174-34.00.120-04A
175-34.00.120-04A

30582
179-34.10.000-15B

30385
175-34.00.140-03C

30387
8.341.000.076D
8.341.000.191

30781
179-34.00.130-26B

30789
175-34.00.130-03A

30385
175-34.00.140-03C

30387
8.341.000.076D
8.341.000.191

Mounting Parts

1.
28085
139-34.00.114-04E

2.
30485
179-34.00.162-26E

3.
00994

4.
00948

5.
30481
4.771.333.000E
000.491.0285

6.
30482
139-34.00.170-09D
139-34.00.180-09C
139-34.00.160-09D

7.
30489
179-34.00.120-25D

Horizontal
LHD
Standard

Series S200

Type

Euro I



S211

OM 442

14,7l tr.

8 cyl.

191 KW/260 HP

Front pipe

Silencer

Tail pipe

30780
179-34.00.130-01A



30678
179-34.10.000-39B

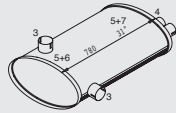

30383
175-34.00.120-05B



30781
179-34.00.130-26B



30778
175-34.00.130-03A



30383
175-34.00.120-05B



Mounting Parts

1.
28085
139-34.00.114-04E



2.
30485
179-34.00.162-26E



3.
00994



4.
00901
8.341.000.112 E
001.987.9640



5.
30481
4.771.333.000E
000.491.0285



6.
30482
139-34.00.170-09D
139-34.00.180-09C
139-34.00.160-09D



7.
34489
179-34.00.120-25D



Horizontal
LHD
Standard

Series S200

Type

Euro I



S213
S214
S215

OM 422
14,7l tr.
8 cyl.
206 KW/280 HP
243 KW/330 HP

Front pipe

30785
179-34.00.120-28A
174-34.00.130-01B

30781
179-34.00.130-26B

30788
179-34.00.130-28A

Silencer

30582
179-34.10.000-15B

Tail pipe

30388
179-34.00.130-25C
0221.310.00

30388
179-34.00.130-25C
0221.310.00

30387
8.341.000.076D
8.341.000.191

30387
8.341.000.076D
8.341.000.191

Mounting Parts

1.
28085
139-34.00.114-04E

2.
30485
179-34.00.162-26E

3.
00948

4.
00994

5.
30481
4.771.333.000E
000.491.0285

6.
30482
139-34.00.170-09D
139-34.00.180-09C
139-34.00.160-09D

7.
34489
179-34.00.120-25D

Horizontal
LHD
Standard

Series S200

Type

Euro I



S213
S214
S215

OM 422
14,7l tr.
8 cyl.
191 KW/260 HP
243 KW/330 HP

OM 442 LA
14,7l tr.
8 cyl.
243 KW/330 HP

Front pipe

30785
179-34.00.120-28A
174-34.00.130-01B

30781
179-34.00.130-26B

30788
179-34.00.130-28A

Silencer

30578
179-34.10.000-39B

Tail pipe

30386
139-34.00.150-14C

30386
139-34.00.150-14C

Mounting Parts

1.
28085
139-34.00.114-04E

2.
30485
179-34.00.162-26E

4.
00994

5.
00901
8.341.000.112 E
001.987.9640

6.
30481
4.771.333.000E
000.491.0285

7.
30482
139-34.00.170-09D
139-34.00.180-09C
139-34.00.160-09D

8.
30489
179-34.00.120-25D

Horizontal
LHD
Standard

Series S200

Type



④X②
⑥X②

S213 UL
S215 SL
S215 UL
SG221 VL

🔧 **OM 407 H**
11,0 ltr.
6 cyl.
132 KW/180 HP

🔧 **OM 427 H**
12,0l tr.
6 cyl.
150 KW/201 HP

🔧 **OM 447 H**
12,0l tr.
6 cyl.
177 KW/240 HP

🔧 **MAND 2566 UH**
11,5 ltr.
6 cyl.
155 KW/211 HP

🔧 **MAND 2866 UH**
12,0l tr.
6 cyl.
177 KW/240 HP

Front pipeT

30767
179-34.00.140-31

Silencer

30576
179-34.10.000-16C

ail pipe

30380
179-34.00.112-31B

Mounting Parts

1.
00940

2.
00901
8.341.000.112 E
001.987.9640

3.
30481
4.771.333.000E
000.491.0285

4.
00994

5.
30458
179-34.00.114-07

Horizontal
LHD
Standard

Series S200

Type

Euro I



S215 HU
S215 HRI
S215 HR
S215 HOU
S215 HI
S215 HDI
S215 HD
S215 H

OM 422 A
14,7l tr.
8 cyl.
243 KW/330 HP

OM 442 A
14,7l tr.
8 cyl.
260 KW/354 HP

Horizontal
LHD
Standard

Front pipe

30777
139-34.00.130-10B



30775
179-34.00.190-25A



30772
179-34.00.120-27B



Silencer

30585
179-34.10.000-14B
0201.113.00

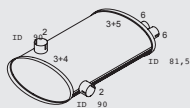

Tail pipe

30388
179-34.00.130-25C
0221.310.00



30388
179-34.00.130-25C
0221.310.00



30387
8.341.000.076D
8.341.000.191



30387
8.341.000.076D
8.341.000.191



Mounting Parts

1.
30484
139-34.00.116-09E



2.
00901
8.341.000.112 E
001.987.9640



3.
30481
4.771.333.000E
000.491.0285



4.
30482
139-34.00.170-09D
139-34.00.180-09C
139-34.00.160-09D



5.
30489
179-34.00.120-25D



6.
00948



Series S200

Type

Euro I



4X2

S215 HD

MAND 2866
KOH/360
12,0l tr.
6 cyl.
265 KW/360 HP

(Incl.T ornado
made inS pain)

Front pipe

30755
139-34.00.120-14



30751
139-34.00.130-14



30752
139-34.00.140-14



Silencer

30574
139-34.10.000-07

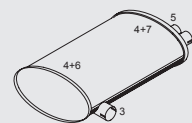

Tail pipe

30377
139-34.00.180-14



30377
139-34.00.180-14



Mounting Parts

1.
10459



2.
30472
138-34.00.113-03
629.492.0080



3.
00961
139-34.00.191-14
629.491.0040
000.492.1240



4.
30481
4.771.333.000E
000.491.0285



5.
00981
179.34.00.112-07
179-34.00.160-10



6.
30482
139-34.00.170-09D
139-34.00.180-09C
139-34.00.160-09D



7.
30489
179-34.00.120-25D



8.
30473
139-34.00.190-14



9.
30479
4.771.244.000
347.504.0012



10.
00968
138-34.00.111-030



Horizontal
LHD
Standard

Series S200

Type

Euro I



4X2

S215 HD

MAND 2866
LOH
12,0l tr.
6 cyl.
243 KW/330 HP

MAND 2866
LXOH
12,0l tr.
6 cyl.
265 KW/360 HP

(Incl.T omado
made in Spain)

Front pipe

30755
139-34.00.120-14



30751
139-34.00.130-14



30752
139-34.00.140-14



Silencer

30579
139-34.10.000-06

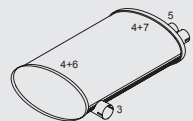

Tail pipe

30386
139-34.00.150-14C



30386
139-34.00.150-14C



Mounting Parts

1.
10459



2.
30472
138-34.00.113-03
629.492.0080



3.
00961
139-34.00.191-14
629.491.0040
000.492.1240



4.
30481
4.771.333.000E
000.491.0285



5.
00981
8.341.000.112 E
001.987.9640



6.
30482
139-34.00.170-09D
139-34.00.180-09C
139-34.00.160-09D



7.
30489
179-34.00.120-25D



8.
30473
139-34.00.190-14



9.
30479
4.771.244.000
347.504.0012



10.
00968
138-34.00.111-030



Horizontal
LHD
Standard

Series S200

Type

Euro I



S215 HDH
S217 HDH

OM 402 LA
13,0l tr.
8 cyl.
280 KW/381 HP

OM 442 LA
14,7l tr.
8 cyl.
320 KW/435 HP

Front pipe

Silencer

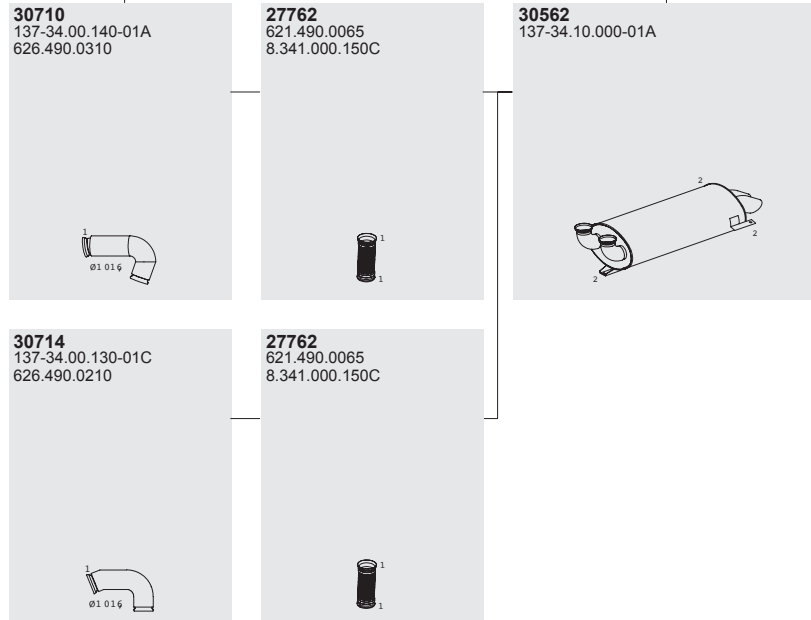

Mounting Parts

1. Zinc
28410
8.341.000.148
621.997.0090

1. Inox
28091

2.
30481
4.771.333.000E
000.491.0285

Horizontal
LHD
Standard

Series S200

Type

Euro I



S216 HD

OM 422 A
14,7l tr.
8 cyl.
243 KW/330 HP

OM 442 A/LA
14,7l tr.
8 cyl.
260 KW/354 HP
320 KW/435 HP

139.0000 ▶CHno
▶CHno 10.25001

Front pipe

30777
139-34.00.130-10B

30775
179-34.00.190-25A

30776
139-34.00.190-09A

S216, OM 422LA only

30772
179-34.00.120-27B

Silencer

30585
179-34.10.000-14B
0201.113.00

Tail pipe

30388
179-34.00.130-25C
0221.310.00

30388
179-34.00.130-25C
0221.310.00

30387
8.341.000.076D
8.341.000.191

30387
8.341.000.076D
8.341.000.191

Mounting Parts

1.
30484
139-34.00.116-09E

2.
00901
8.341.000.112 E
001.987.9640

3.
30481
4.771.333.000E
000.491.0285

4.
30482
139-34.00.170-09D
139-34.00.180-09C
139-34.00.160-09D

5.
30489
179-34.00.120-25D

6.
00948

Horizontal
LHD
Standard

Series S200

Type

→ 1989



S228 DI
S228 DTI

OM 422 A/LA
14,7l tr.
8 cyl.
243 KW/330 HP
276 KW/375 HP

OM 402 LA
13,0l tr.
8 cyl.
280 KW/381 HP

OM 422 LA
14,7l tr.
8 cyl.
276 KW/375 HP

WKK 139.0000
10.30086 ▶CHno

Front pipe

30786
139-34.00.130-11B



30776
139-34.00.190-09A



30787
139-34.00.120-11

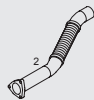

Silencer

30585
179-34.10.000-14B
0201.113.00

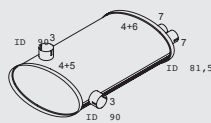

Tail pipe

30382
139-34.00.150-09C



30382
139-34.00.150-09C



30387
8.341.000.076D
8.341.000.191



30387
8.341.000.076D
8.341.000.191



Mounting Parts

1.
30484
139-34.00.116-09E



2.
00940



3.
00901
8.341.000.112 E
001.987.9640



4.
30481
4.771.333.000E
000.491.0285



5.
30482
139-34.00.170-09D
139-34.00.180-09C
139-34.00.160-09D



6.
30489
179-34.00.120-25D



7.
00948



Horizontal
LHD
Standard

Series S200

Type

Euro II
1990 →



S228 DT
S228 DTI

OM 402 A/LA
13,0l tr.
8 cyl.
177 KW/240 HP
280 KW/381 HP

OM 442 LA
14,7l tr.
8 cyl.
276 KW/375 HP

Horizontal
LHD
Standard

Front pipe

30758
139-34.00.140-15



27763
8.341.000.147E



27763
8.341.000.147E



30756
139-34.00.160-15



27762
621.490.0065
8.341.000.150C



27763
8.341.000.147E



30757
139-34.00.150-15



Silencer

30573
139-34.10.000-09A

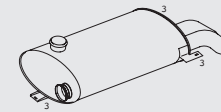

Mounting Parts

1.
00988



2. Inox
28091



2.
28410
8.341.000.148
621.997.0090



3.
30481
4.771.333.000E
000.491.0285



Series S200

Type

Euro II



S250

MAND 2866
LOH
12,0l tr.
6 cyl.
243 KW/330 HP

Front pipe

34719
315-34.00.140-13D



34713
315-34.00.130-13B
626.490.0710



34711
133-34.00.130-01C



Silencer

34561
133-34.10.000-01A

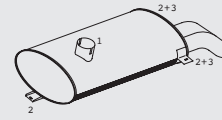

Mounting Parts

1.
00961
139-34.00.191-14
629.491.0040
000.492.1240



2.
34481
4.771.333.000E
000.491.0285



3.
34456
315-35.000.113-04D
315-34.00.113-04D



4.
34472
138-34.00.113-03
629.492.0080



5.
00968
138-34.00.111-030



Horizontal
LHD
Standard

Series S200

Type

Euro I



SG219 SL

OM 407 H
11,0 ltr.
6 cyl.
132 KW/180 HP

OM 427 H
12,0l tr.
6 cyl.
150 KW/204 HP

OM 447 H
12,0l tr.
6 cyl.
177 KW/240 HP

MAND 2566 UH
11,5 ltr.
6 cyl.
155 KW/211 HP

MAND 2866 UH
12,0l tr.
6 cyl.
177 KW/241 HP

Silencer



Mounting Parts

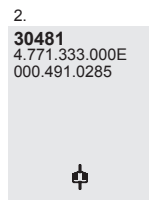

Horizontal
LHD
Standard

Series S300

Type

Euro II
09/91 → 02/02



S309 HD

OM 401 LA
9,6l tr.
6 cyl.
213 KW/290 HP

Front pipe

30733
309-34.00.120-04C
309-34.00.120-03C
626.490.0410
Insulation



Silencer

30556
309-34.10.000-01B

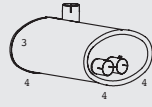

Tail pipe

30370
309-34.00.140-01B



30370
309-34.00.140-01B



Mounting Parts

1.
28410
8.341.000.148
621.997.0090



2.
00901
8.341.000.112 E
001.987.9640



3.
30482
139-34.00.170-09D
139-34.00.180-09C
139-34.00.160-09D



3A. Alternative.
30415
309-34.00.170-01D



4.
30481
4.771.333.000E
000.491.0285



5.
00942



Horizontal
LHD
Standard

Series S300

Type

Euro II
09/91 → 02/02



S312 HD
S313 HD
S314 HD
S315 HD

OM 401 LA
9,6l tr.
6 cyl.
200 KW/272 HP
230 KW/313 HP

OM 441 LA
12,8l tr.
6 cyl.
250 KW/340 HP

Front pipe

30762
315-34.00.130-08



27762
621.490.0065
8.341.000.150C



30765
315-34.00.120-08



Silencer

30571
315-34.10.000-04A

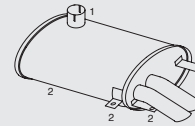

Mounting Parts

1.
00784



2.
30481
4.771.333.000E
000.491.0285



3.
28410
8.341.000.148
621.997.0090



3. Alternative. Inox
28091



Horizontal
LHD
Standard

Series S300

Type

Euro II
09/91 → 02/02



S312 HD
S315 HD

OM 442 A
14,7l tr.
8 cyl.
250 KW/340 HP

OM 402 LA
12,8l tr.
8 cyl.
280 KW/381 HP

OM 442 LA
14,7l tr.
8 cyl.
320 KW/435 HP

Front pipe

27762
621.490.0065
8.341.000.150C



30763
315-34.00.120-05



30769
315-34.00.130-05



27762
621.490.0065
8.341.000.150C



27763
8.341.000.147E



30760
315-34.00.140-05



Silencer

30572
315-34.10.000-01B

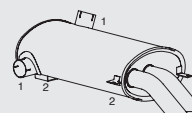

30564
315.34.10.000.050

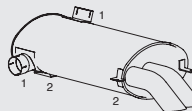

Mounting Parts

1.
00981
179.34.00.112-07
179-34.00.160-10



2.
30481
4.771.333.000E
000.491.0285



3.
27410
8.341.000.148
621.997.0090



3. Alternative. Inox
27091



4.
00988



Horizontal
LHD
Standard

Series S300

Type

Euro II
09/91 → 02/02



S312 HD
S315 HD
S315 H
S315 GT
S315 HDH
S315 GT
S315 HD

OM 442 LA
14,7l tr.
8 cyl.
320 KW/435 HP
370 KW/503 HP

Front pipe

Silencer

30727
627.490.0210
327-34.00.120-01A



30569
315-34.10.000.07A

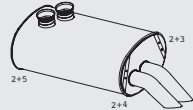

30726
627.490.0110
327-34.00.130-01A



Mounting Parts

1.
28410
8.341.000.148
621.997.0090



1. Alternative. Inox
28091



2.
30481
4.771.333.000E
000.491.0285



3.
30453
315-34.00.112-09D



4.
30418
315-34.00.113-09D



5.
30452
315-34.00.111-09E



Horizontal
LHD
Standard

Series S300

Type

Euro II
09/91 → 02/02



S313 UL
S314 UL
S315 UL
S316 UL
S317 UL
S318 UL
S319 UL



SG321 UL

OM 447 HLA
12,0l tr.
6 cyl.
184 KW/250 HP
220 KW/299 HP

Horizontal
LHD
Standard

Front pipe

30759
325-34.00.150-01



30754
325-34.00.130-01



Silencer

30568
325-34.10.000-01

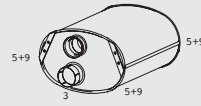

30371
321-34.00.111-01

SG321 UL



30566
149-34.10.000-22

SG321 UL



Tail pipe

30372
321-34.00.120-01

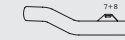

30374
325-34.00.160-01
325-34.00.130-03
325-34.00.120-01
S313 UL, S314 UL,
S315 UL, S316 UL,
S317 UL, S318 UL,
S319 UL

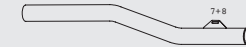

Mounting Parts

1.
00981
179.34.00.112-07
179.34.00.160-10



2.
28410
8.341.000.148
621.997.0090



2. Alternative. Inox
28091



3.
00971



4.
30466
321-34.00.140-01



5.
30465
325-34.00.140-01



6.
30461
179-34.00.113-045



7.
10078



8.
30462
137-34.00.111-02



9.
30481
4.771.333.000E
000.491.0285



Series S300

Type

Euro II
09/91 → 02/02



S313 UL
S314 UL
S315 UL
S316 UL
S317 UL
S318 UL
S319 UL



SG321 UL

D2866 LUH
12,0l tr.
6 cyl.
191 KW/260 HP
228 KW/310 HP

Front pipe

30718
325-34.00.140-02

30717
325-34.00.130-02

Silencer

30567
325-34.10.000-04

Tail pipe

30374
325-34.00.160-01
325-34.00.130-03
325-34.00.120-01

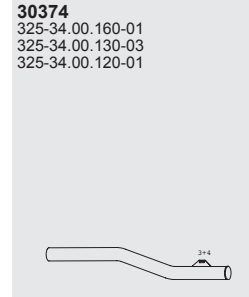
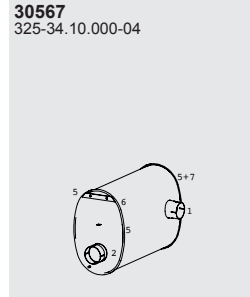
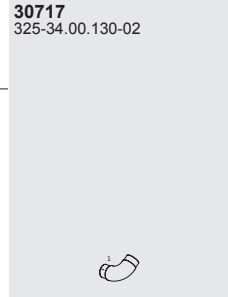
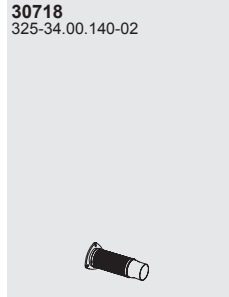

Mounting Parts

1.
00981
179.34.00.112-07
179-34.00.160-10

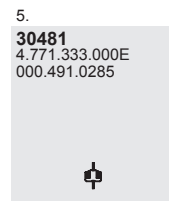
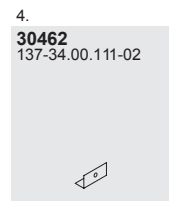
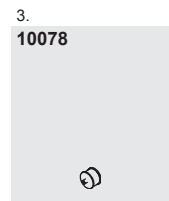
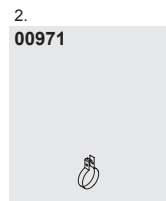

Horizontal
LHD
Standard

Series S300

Type

Euro II
09/91 → 02/02



S315

D2866 LOH
12,0l tr.
6 cyl.
243 KW/330 HP
272 KW/370 HP
309 KW/420 HP

Front pipe

30719
315-34.00.140-13D



30713
315-34.00.130-13B
626.490.0710

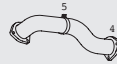

30712
315-34.00.120-13
133-34.00.120-13



Silencer

30561
133-34.10.000-01A

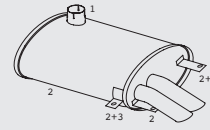

Mounting Parts

1.
00961
139-34.00.191-14
629.491.0040
000.492.1240



2.
30481
4.771.333.000E
000.491.0285



3.
30456
315-35.000.113-04D
315-34.00.113-04D



4.
30472
138-34.00.113-03
629.492.0080



5.
00968
138-34.00.111-030



Horizontal
LHD
Standard

Series S300

Type

Euro II
09/91 → 02/02



S315

OM 442
15,0l tr.
8 cyl.
191 KW/260 HP
206 KW/280 HP
220 KW/299 HP

Front pipe

30773
315-34.00.140-03



28679
8.341.000.151C



30779
315-34.00.150-03



30768
315-34.00.120-04



28679
8.341.000.151C



28674
8.341.000.184
617.492.0008



30770
315-34.00.130-03



Silencer

30577
315-34.10.000-02B

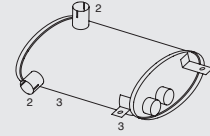

Tail pipe

30384
315-34.00.111-04D



30384
315-34.00.111-04D



Mounting Parts

1.
28478
8.341.000.183



1. Alternative. Inox
28096



2.
00994



3.
30481
4.771.333.000E
000.491.0285



4.
00981
179.34.00.112-07
179-34.00.160-10



5.
00992



Horizontal
LHD
Standard

Series S300

Type

Euro II
09/91 → 02/02



S315 HD GT

OM 441 LA
11,0 ltr.
6 cyl.
230 KW/313 HP
243 KW/330 HP
250 KW/340 HP

Front pipe

30727
627.490.0210
327-34.00.120-01A



Silencer

30563
327-34.10.000.01A

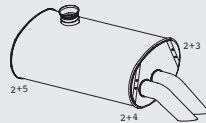

Mounting Parts

1.
28410
8.341.000.148
621.997.0090



1. Alternative. Inox
28091



2.
30481
4.771.333.000E
000.491.0285



3.
30453
315-34.00.112-09D



4.
30418
315-34.00.113-09D



5.
30452
315-34.00.111-09E



Horizontal
LHD
Standard

Series S300

Type

Euro II
09/91 → 02/02



S315 HDH



S316 HDS
S317 HDH /3

OM 402 LA
12,9l tr.
8 cyl.
280 KW/381 HP

OM 442 LA
14,7l tr.
8 cyl.
320 KW/435 HP
370 KW/503 HP

Front pipe

Silencer

30710
137-34.00.140-01A
626.490.0310

Insulation



27762
621.490.0065
8.341.000.150C



30562
137-34.10.000-01A

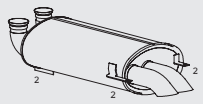

30714
137-34.00.130-01C
626.490.0210

Insulation



27762
621.490.0065
8.341.000.150C



Mounting Parts

1.
28410
8.341.000.148
621.997.0090



1. Alternative. Inox
28091



2.
30481
4.771.333.000E
000.491.0285



Horizontal
LHD
Standard

Series S300

Type

Euro II
09/91 → 02/02



S315 HDH/3
S317 HDH/3

OM 502 LA
16,0l tr.
8 cyl.
320 KW/435 HP
350 KW/476 HP
370 KW/503 HP

Horizontal
LHD
Standard

Front pipe

30735
629.490.0810A
345-34.00.110-01B



Silencer

30558
629.491.0300A

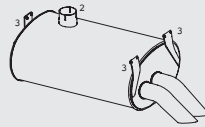

Mounting Parts

1.
28043
942.997.0090



2.
30414
629.491.0040D



3.
30413
000.491.0285



Series S300

Type

Euro II
09/91 → 02/02



S315 NF

OM 447 HLA
12,0l tr.
6 cyl.
184 KW/250 HP
220 KW/299 HP

Front pipe

30753
353-34.00.130-01
627.490.0035



Silencer

30570
353-34.10.000-01

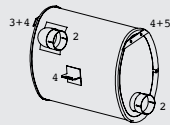

Tail pipe

30376
353-34.00.120-01
627 490 0227



Mounting Parts

1.
28410
8.341.000.148
621.997.0090



1. Alternative. Inox
28091



2.
00981
179.34.00.112-07
179-34.00.160-10



3.
30474
353-34.00.114-01



4.
30481
4.771.333.000E
000.491.0285



5.
30468
353-34.00.112-01



6.
30467
137-34.00.111-02



7.
10078



Horizontal
LHD
Standard

Series S300

Type

Euro II
09/91 → 02/02



S328 DT

OM 402 LA
12,8l tr.
8 cyl.
280 KW/381 HP

OM 442 LA
14,7l tr.
8 cyl.
320 KW/435 HP
370 KW/503 HP
385 KW/523 HP

Front pipe

Silencer

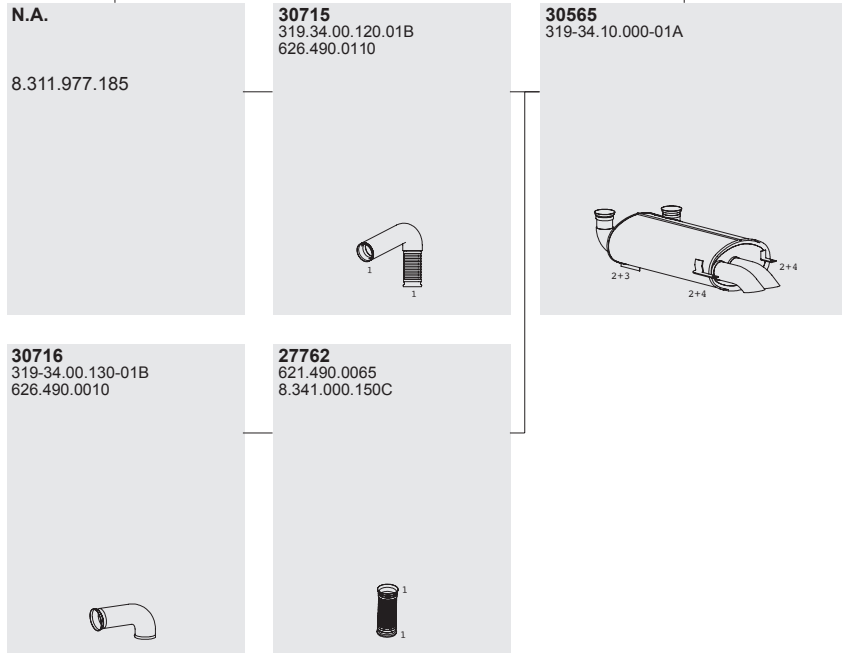

Mounting Parts

- | | | | | |
|---|--|--|--|---|
| <p>1.
28410
8.341.000.148
621.997.0090</p> | <p>1. Alternative. Inox
28091</p> | <p>2.
30481
4.771.333.000E
000.491.0285</p> | <p>3.
30457
139-34.00.111-15D</p> | <p>4.
30456
315-35.000.113-04D
315-34.00.113-04D</p> |
|---|--|--|--|---|

Horizontal
LHD
Standard

Series S400

Type

Euro III
10/01 →



S411 HD

OM 501 LA
12,0l tr.
6 cyl.
260 KW/354 HP
300 KW/408 HP

Front pipe

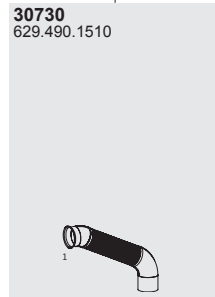

Silencer

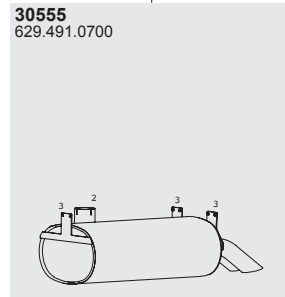

Mounting Parts

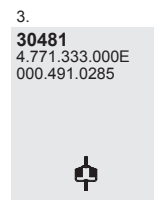
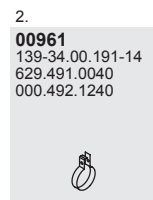

Horizontal
LHD
Standard

Series S400

Type

Euro III
10/01 →



S415 HD



S415 HDH



OM 457 LA
12,0l tr.
6 cyl.
260 KW/354 HP
310 KW/422 HP
315 KW/428 HP
335 KW/455 HP

Front pipe

Silencer

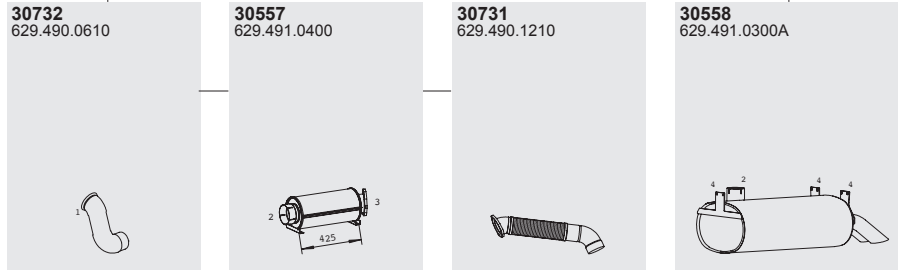

Mounting Parts

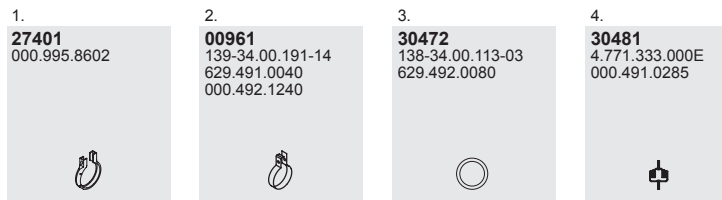

Horizontal
LHD
Standard

Series S400

Type

Euro III
10/01 →



S415 HD



S415 HDH
S416 HDH
S417 HDH

OM 502 LA
16,0l tr.
8 cyl.
320 KW/435 HP
350 KW/476 HP
370 KW/503 HP

Front pipe

Silencer

30735
629.490.0810A
345-34.00.110-01B



30558
629.491.0300A

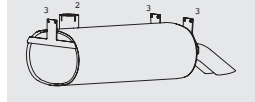

21672
629.490.1910
AEM Insulation



21673
629.490.2310
AEM



Mounting Parts

1.
28043
942.997.0090



2.
00961
139-34.00.191-14
629.491.0040
000.492.1240



3.
30413
000.491.0285

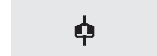

Horizontal
LHD
Standard

Series S400

Type

Euro III
10/01 →



S416 HDH
S417 HDH

OM 457 LA
12,0l tr.
6 cyl.
260 KW/354 HP
310 KW/422 HP
315 KW/428 HP
335 KW/455 HP

Front pipe

Silencer

30732
629.490.0610



30557
629.491.0400

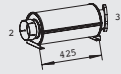

30731
629.490.1210



30558
629.491.0300A

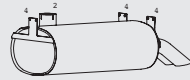

Mounting Parts

1.
27401
000.995.8602



2.
00961
139-34.00.191-14
629.491.0040
000.492.1240



3.
30472
138-34.00.113-03
629.492.0080



4.
30481
4.771.333.000E
000.491.0285



Horizontal
LHD
Standard

Series S400

Type

Euro III
10/02 →



S431 DT

OM 502 LA
16,0l tr.
8 cyl.
350 KW/476 HP
370 KW/503 HP

Front pipe

Silencer

30798
410.490.0110
410.490.0010
AEM Insulation



30558
629.491.0300A

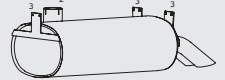

Mounting Parts

1.
28043
942.997.0090



2.
00961
139-34.00.191-14
629.491.0040
000.492.1240



3.
30481
4.771.333.000E
000.491.0285



Horizontal
LHD
Standard

Series S400

Type

Euro III
10/03 →



S415 GT

OM 457 HLA
12,0l tr.
6 cyl.
185 KW/252 HP
220 KW/299 HP
260 KW/354 HP
300 KW/408 HP

Front pipe

21670
629.490.2010
629.490.0910

AEM Insulation



Silencer

27516
629.490.0301

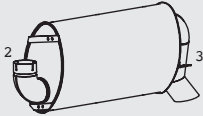

Mounting Parts

1.
27401
000.995.8602



2.
00961
139-34.00.191-14
629.491.0040
000.492.1240



3.
30481
4.771.333.000E
000.491.0285



Horizontal
LHD/RHD
Standard

Series S400

Type

Euro III
10/03 →



S415 GT -H D



S416 GT -H D



S417 GT -H D



OM 457 LA
12,0l tr.
6 cyl.
260 KW/354 HP
310 KW/422 HP
315 KW/428 HP
335 KW/455 HP

OM 502 LA
16,0l tr.
8 cyl.
320 KW/435 HP
350 KW/476 HP
370 KW/503 HP

Front pipe

Silencer

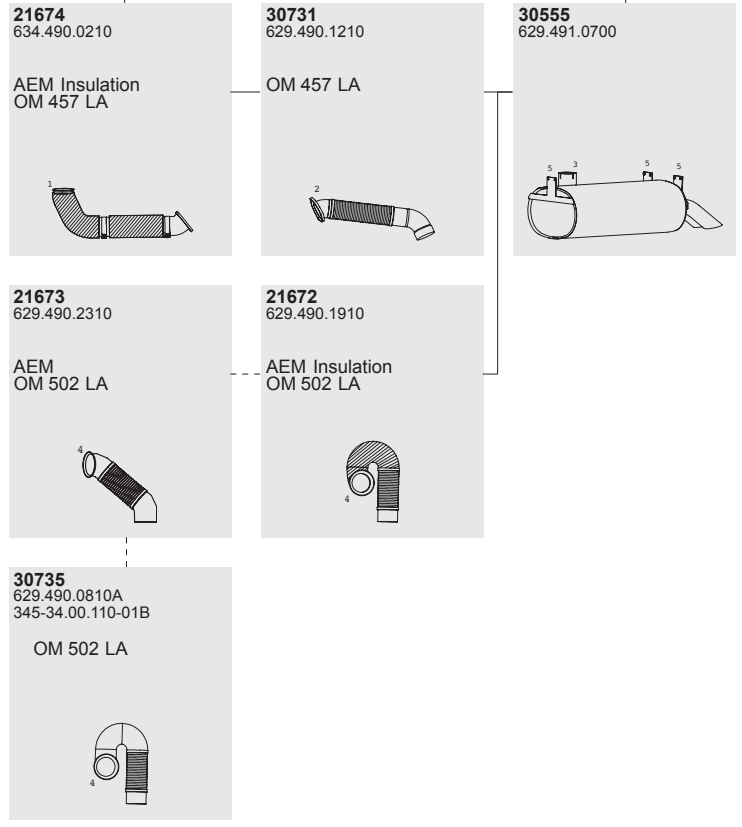

Mounting Parts

- | | | | | |
|------------------------------------|--|--|------------------------------------|--|
| 1.
27401
000.995.8602 | 2.
30472
138-34.00.113-03
629.492.0080 | 3.
00961
139-34.00.191-14
629.491.0040
000.492.1240 | 4.
28043
942.997.0090 | 5.
30481
4.771.333.000E
000.491.0285 |
| | | | | |

Horizontal
LHD/RHD
Standard

Series S400

Type

Euro IV
01/05 →



④X②
⑥X②

S 415 NF
S 416 NF

🔧 **OM 906 LA**
6,4l tr.
6 cyl.
210 KW/286 HP

🔧 **OM 457 HLA**
12,0l tr.
6 cyl.
220 KW/299 HP
260 KW/354 HP

Front pipe

Silencer

Tail pipe

23770
628.490.2919

OM 906 LA



1

27597
001.490.2714
001.490.7914

DPF
Complete unit
Replaceable parts:3 ,4,5,6

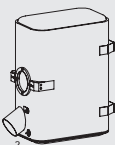

2

27393
628.490.1727



23774
628.490.2019

OM 457 HLA



1

27394
628.490.2027



Mounting Parts

1.
28410
8.341.000.148
621.997.0090



2.
00961
139-34.00.191-14
629.491.0040
000.492.1240



3. DPF
27876
000.490.2792



4. Gasket
27026
000.490.0380



5. Gasket
27027
000.490.0180



6. Cover
27025
000.491.0303



Horizontal
LHD/RHD
Standard

Series S400

Type

Euro IV
10/03 →



④X②

S 415 GT
S 416 GT



④X②
⑥X②/④

S 412 UL
S 415 UL
S 416 UL
S 417 UL
S 419 UL

✎ **OM 457 HLA**
12,0l tr.
6 cyl.
220 KW/299 HP
260 KW/354 HP
300 KW/408 HP

Front pipeT

23772
633.490.1410



Silencer

27597
001.490.2714
001.490.7914

DPF
Complete unit
Replaceable parts:4 ,5,6,7

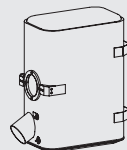

ail pipe

27390
633.490.1510

Inox

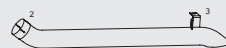

Mounting Parts

1.
27401
000.995.8602



2.
00961
139-34.00.191-14
629.491.0040
000.492.1240



3.
30481
4.771.333.000E
000.491.0285



4. DPF
27876
000.490.2792



5. Gasket
27026
000.490.0380



6. Gasket
27027
000.490.0180



7. Cover
27025
000.491.0303



Horizontal
LHD/RHD
Standard

Series S400

Type

Euro IV
01/2005 →



S 415 NF
2-TUERER
S 415 NF
3-TUERER
S 416 NF

OM 457 HLA
12,0l tr.
6 cyl.
220 KW/299 HP
260 KW/354 HP

Front pipe Silencer Tail pipe

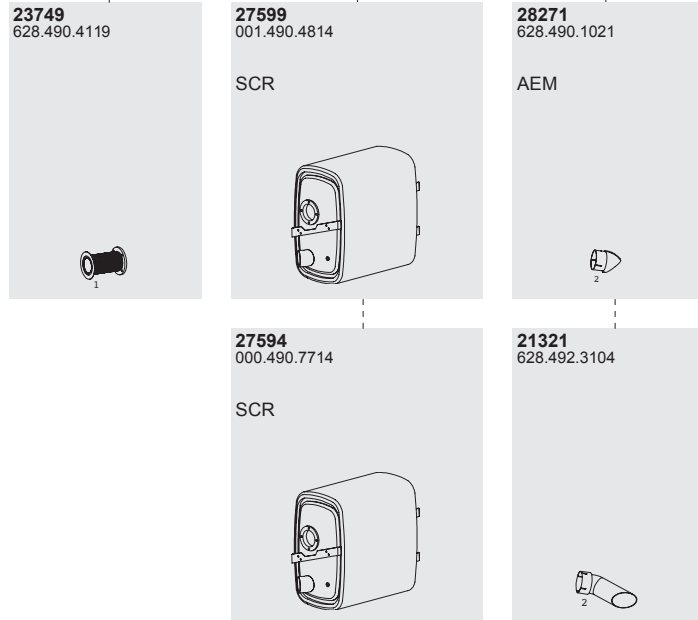

Mounting Parts

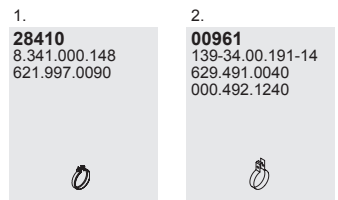

Horizontal
LHD/RHD
Standard

Series S400

Type

Euro IV
10/03 →



④X②

S 415 GT
S 416 GT

④X②

⑥X②/④

S 412 UL
S 415 UL
S 416 UL
S 417 UL
S 419 UL

OM 457 HLA
12,0l tr.
6 cyl.
220 KW/299 HP
260 KW/354 HP
300 KW/408 HP

Front pipeT Silencer ail pipe

21667
633.490.1010
633.490.1610

Insulation



27596
001.490.2814

SCR

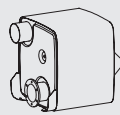

21330
633.490.0327

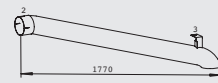

21648
633.490.1210
633.490.1310
633.490.1810



27595
001.490.4914

SCR
With NOx sensor

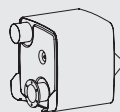

21368
633.490.0427

Excl.S 416 GT

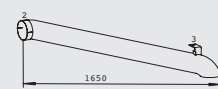

21347
633.490.0527

Inox
With NOx sensor



Mounting Parts

1.
27401
000.995.8602



2.
00961
139-34.00.191-14
629.491.0040
000.492.1240



3.
30481
4.771.333.000E
000.491.0285



Horizontal
LHD/RHD
Standard

Series S400

Type

Euro IV
01/05 →



S 415 HD



S 415 HDH
S 416 HDH
S 417 HDH

☞ **OM 457 LA**
12,0l tr.
6 cyl.
260 KW/354 HP
315 KW/428 HP

☞ **OM 502 LA**
16,0l tr.
8 cyl.
350 KW/476 HP
370 KW/503 HP

Horizontal
LHD/RHD
Standard

Front pipe

Silencer

Tail pipe

21679
632.490.0410

AEM Insulation



21675
632.490.0110



27590
001.490.2914
000.490.8214

SCR
OM 457 LA



21339
632.490.0210

AEM



21677
632.490.0010
632.490.0910

Excl.S 415 HD

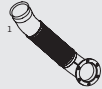

27546
001.490.3014

SCR



21334
632.490.0310

AEM



Mounting Parts

1.
27401
000.995.8602



2.
00011



Series S400

Type

Euro IV
01/05 →



S4 11 HD
S 415 HD



S 415 HDH
S 416 HDH
S 417 HDH

OM 501 LA
12,0l tr.
6 cyl.
260 KW/354 HP
300 KW/408 HP

OM 457 LA
12,0l tr.
6 cyl.
260 KW/354 HP
315 KW/428 HP
335 KW/455 HP

OM 502 LA
16,0l tr.
8 cyl.
350 KW/476 HP
370 KW/503 HP

Front pipe

30797
632.490.0510

OM 501 LA



21677
632.490.0010
632.490.0910

OM 457 LA



21679
632.490.0410

AEM Insulation
Excl.S 411H D



21676
632.492.0004
632.490.0810

Excl.S 411H D



Silencer

27590
001.490.2914
000.490.8214

SCR
S4 11 HD

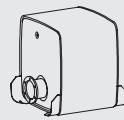

27547
002.490.2314

SCR
With NOx sensor
S 415 HDH
S 416 HDH
S 417 HDH

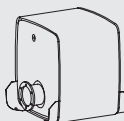

21545
002.490.4814

SCR



Tail pipe

21339
632.490.0210

AEM
S4 11 HD



21334
632.490.0310

AEM



Mounting Parts

1.
27401
000.995.8602



2.
00011



Horizontal
LHD/RHD
Standard

Series S400

Type

Euro IV
01/06 →



S 416 GT-H D
S 417 GT-H D

OM 457 LA
12,0l tr.
6 cyl.
260 KW/354 HP

Front pipe

21677
632.490.0010
632.490.0910

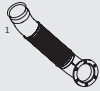

Silencer

27546
001.490.3014

SCR

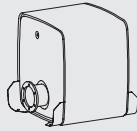

Tail pipe

21334
632.490.0310

AEM



27547
002.490.2314

SCR
With NOX sensor

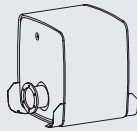

Mounting Parts

1.
27401
000.995.8602



2.
00011



Horizontal
LHD/RHD
Standard

Series S400

Type

Euro IV
01/03 →



④X②
⑥X②

S 415 GT -H D
S 416 GT -H D
S 417 GT -H D

OM 457 LA
12,0l tr.
6 cyl.
260 KW/354 HP

Front pipe

21679
632.490.0410

AEM Insulation



21676
632.492.0004
632.490.0810



Silencer

27590
001.490.2914
000.490.8214

SCR

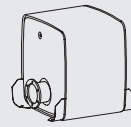

27547
002.490.2314

SCR
With NOX sensor

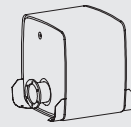

Tail pipe

21339
632.490.0210

AEM



21334
632.490.0310

AEM



Mounting Parts

1.
27401
000.995.8602



2.
00011



Horizontal
LHD/RHD
Standard

SOYLU / OTOBÜS

SOLARIS



Urbino

504

Vacanza

507

Series URBINO

Type

Euro III
1999 →



Urbino 12

D286 LOH27
12,0l tr.
6 cyl.
265 KW/360 HP

Front pipe

79785
P0299981110



Silencer

19584
P0120432241

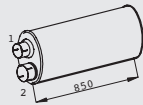

Tail pipe

79387
P0299999210



Mounting Parts

1.
00942



2.
00981



Horizontal
LHD
Standard

Series URBINO

Type

Euro III
1999 →



Urbino 15

DAF PE 228 C
9,2l tr.
6 cyl.
228 KW/310 HP

Front pipe

79781
P0120432245



Silencer

79583
P0120432268

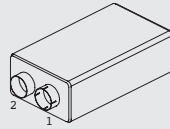

Tail pipe

79386
P0120432262

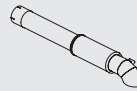

Mounting Parts

1.
00968



2.
00961



Horizontal
LHD
Standard

Series URBINO

Type

Euro III
1999 →



Urbino 15

D286 LOH27
12,0l tr.
6 cyl.
265 KW/360 HP

Front pipe

79782
WW0299998100



Silencer

19584
P0120432241

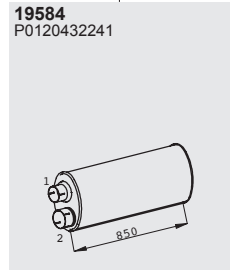

Tail pipe

N.A.

WW0299999200

Mounting Parts

1.
00942

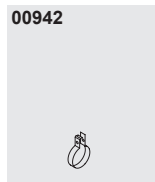

2.
00981

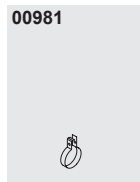

Horizontal
LHD
Standard

Series **VACANZA**

Type

Euro III



Vacanza 12/13

DAF XE 315 C
12.6l tr.
6 cyl.
315 KW/428 HP

Horizontal
LHD
Standard

Front pipe

79788
P0299985230

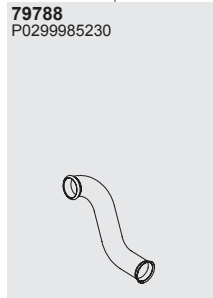

N.A.

P0299985220

Silencer

67598
P1122349000



Tail pipe

N.A.

P0299985210

SOYLU / OTOBÜS

TEMSA

Opalin

509

Safari

510



Series OPALIN

Type

Euro III



Opalin 9



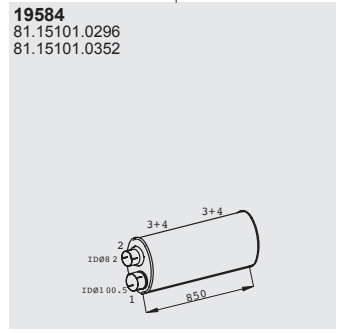

D0836 LFL
 7,0l tr.
 6 cyl.
 162 KW/220 HP

Silencer



19584
 81.15101.0296
 81.15101.0352

Mounting Parts

- | | | | |
|--|--|--|--|
| <p>1.
10497</p>  | <p>2.
00942</p>  | <p>3.
10472</p>  | <p>4.
10089</p>  |
|--|--|--|--|

Horizontal
 LHD
 Standard

Series SAFARI**Type**

Euro III

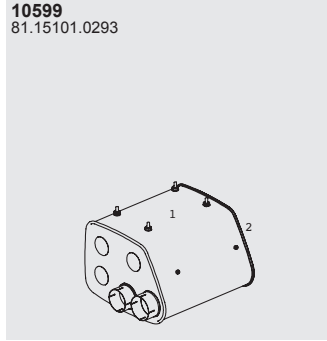

4X2

Safari 12 IC
Safari 13 ICD2866 LOH
12,0l tr.
6 cyl.
228 KW/310 HP
265 KW/360 HP**Silencer****10599**
81.15101.0293**Mounting Parts**1.
10493
81.15110.02962.
10405
81.15110.0300Horizontal
LHD
Standard

Series SAFARI

Type

Euro III



4X2

TB 162Z
TB 162Y
TB 162X
TB 162W

D2866
12,0l tr.
6 cyl.
228 KW/310 HP
265 KW/360 HP
301 KW/410 HP

Front pipe

79470
TC298822-041Y



79473
TC298822-003Y



79789
TC298822-040Y



19753
81.15210.0074



79665
TC298822-163Y



Silencer

19599
81.15101.0293

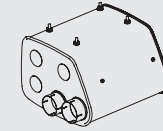

Tail pipe

79389
TC298822-164Y



Mounting Parts

1.
00961
81.97420.0157



2.
19447
88.15640.0007



3.
00968
81.97420.0076



Horizontal
LHD/RHD
Standard

Series SAFARI

Type

Euro III



TB 283L

XE 280
12,6l tr.
6 cyl.
280 KW/381 HP

XE 315
12, 6l tr.
6 cyl.
315 KW/428 HP

Front pipe

Silencer

Tail pipe

79783
HD165006Y

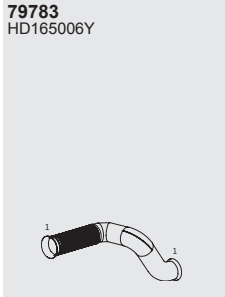

67564
1608809

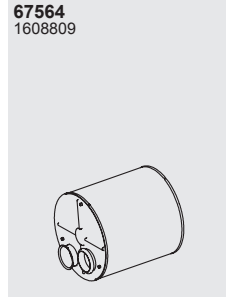

79381
HD165116Y



Mounting Parts

1.

67428
1452973

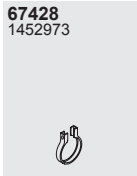

Horizontal
LHD/RHD
Standard

SOYLU / OTOBÜS

VAN HOOL



A 300

514

T 9

516

Series A300**Type**Euro III
2001 →**Silencer**17122
10892757

DPF

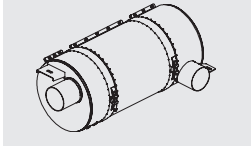
Horizontal
LHD/RHD
Standard

Series A300

Type

Euro III
2001 →④X②
⑥X②

Silencer

17557
10896503

DPF

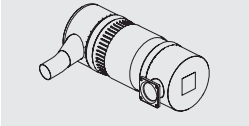
Horizontal
LHD/RHD
Standard

Series T9

Type



Acron
Altano

Front pipeS

59788
621205270



59787
10718681



ilencer

59588
10539519

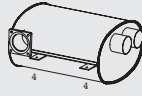

Tail pipe

59388
10718841

L= 660 mm



59387
10601627

L= 800 mm

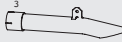

Mounting Parts

1.
00769



2.
59487
10550938



3.
00901



4.
30479



Horizontal
LHD
Standard

SOYLU / OTOBÜS

VOLVO

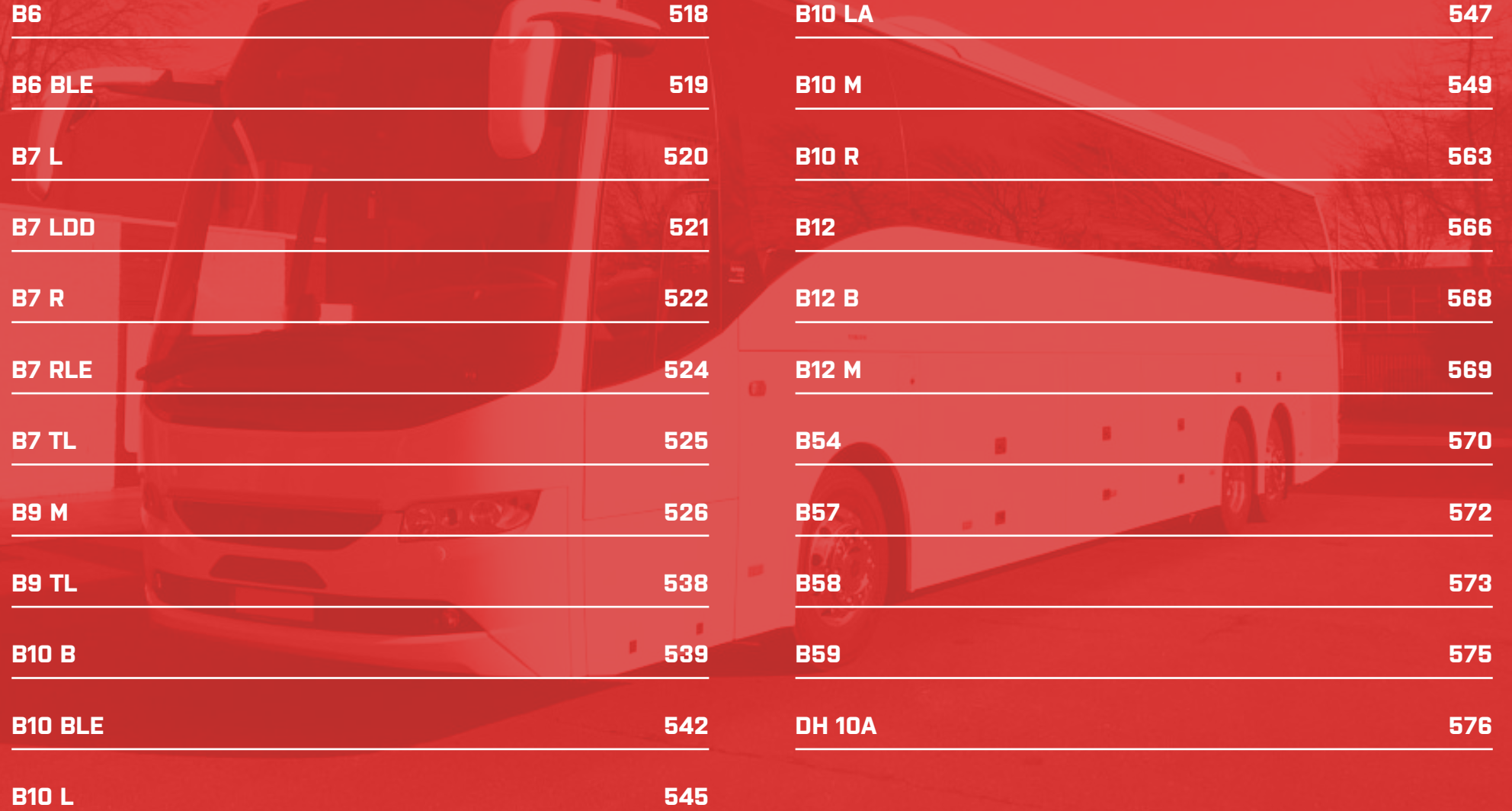

B6	518	B10 LA	547
B6 BLE	519	B10 M	549
B7 L	520	B10 R	563
B7 LDD	521	B12	566
B7 R	522	B12 B	568
B7 RLE	524	B12 M	569
B7 TL	525	B54	570
B9 M	526	B57	572
B9 TL	538	B58	573
B10 B	539	B59	575
B10 BLE	542	DH 10A	576
B10 L	545		

Series B6

Type

Euro I



5000 ▶CHno

Front pipe

Silencer

Tail pipe

47720
3039932



47764
3123830
20442227



47738
3039934



48184
3120427

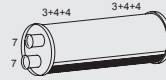

48905
3039213

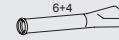

Mounting Parts

1.

48082
1624613
471355



2.

00586T



3.

48022
3039645



4.

48028
6850149
477130800
70305823



5.

08786



6.

48031
9519629
9521182



7.

48078
3033054
9522798



Horizontal
LHD
Standard

Series B6 BLE

Type

Euro I



5000 ▶CHno

Front pipe

47720
3039932

47764
3123830
20442227

47738
3039934

Silencer

48184
3120427

Tail pipe

48905
3039213

47318

46766
3039213

Mounting Parts

1.
48082
1624613
471355

2.
00586T

3.
48022
3039645

4.
48028
6850149
477130800
70305823

5.
08786

6.
48031
9519629
9521182

Horizontal
LHD
Standard

Series B7 L

Type

Euro III



D7C

7,3l tr.

6 cyl.

158 KW/215 HP

184 KW/250 HP

213 KW/290 HP

Front pipe

46790
70330474

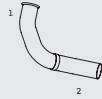

46755
3172178
20442230
1070460



46748
20499563



Silencer

48119
8149232
3162349

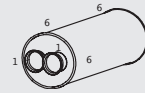

Tail pipe

48989
9959019

Side outlet



47983
9959018

Rear outlet



Mounting Parts

1.
48078
3033054
9522798



2.
08782
1071577
3122287
3123843



3.
00586
8151616
1079026
20871332



4.
48026
1206468



5.
48076
3033362



6.
47080
70305823



Horizontal
LHD
Standard

Series B7 LDD

Type

Euro III



D7C
7,3l tr.
6 cyl.
158 KW/215 HP

Front pipe

46747
70311854



46755
3172178
20442230
1070460



46746
3195570

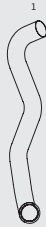

46745
3195567

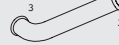

Silencer

48119
8149232
3162349

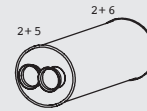

Tail pipe

47984
3178183



Mounting Parts

1.
00586T



2.
48028
6850149
477130800
70305823



3.
48078
3033054
9522798



4.
00986
3194436



5.
47076
3178175



6.
47075
3178176



Horizontal
LHD
Standard

Series B7 R

Type

Euro III



D7A
6,7l tr.
6 cyl.
169 KW/230 HP
191 KW/260 HP
210 KW/286 HP

D7B
6,7l tr.
6 cyl.
169 KW/230 HP
191 KW/260 HP

D7C
7,3l tr.
6 cyl.
202 KW/275 HP
220 KW/300 HP
228 KW/310 HP

Entrance
standard
Entrance low

Front pipe

46741
20498061

46755
3172178
20442230
1070460

46742
20499341

Silencer

48119
8149232
3162349

Tail pipe

47980
3136071

46743
20438367

Low entrance

Mounting Parts

1.
48078
3033054
9522798

2.
48026
1206468

3.
00586
8151616
1079026
20871332

4.
48076
3033362

5.
47071
3136154

6.
48028
6850149
477130800
70305823

Horizontal
LHD/RHD
Standard

Series B7 R

Type

Euro IV
2004 →



D7E290
7,1l tr.
6 cyl.
213 KW/290 HP

Front pipe

46663
20585908



46749
20442236



46668
20585904

Insulation

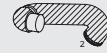

Silencer

48197
20843772

SCR

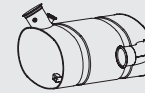

Tail pipe

46987
20593538



Mounting Parts

1.

48497/T
3943850
9957387



2.

48414
508850
1624612
9522768



Horizontal
LHD/RHD
Standard

Series B7 RLE

Type

Euro III



D7C

7,3l tr.
6 cyl.
202 KW/275 HP
220 KW/300 HP
228 KW/310 HP

Low entry

Front pipe

46741
20498061



46755
3172178
20442230
1070460



48916
20438365



Silencer

48119
8149232
3162349

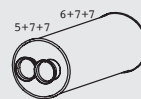

Tail pipe

46743
20438367

Low entrance



47980
3136071

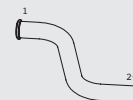

Mounting Parts

1.
48078
3033054
9522798



2.
48026
1206468



3.
00586
8151616
1079026
20871332



4.
48076
3033362



5. 8196608
NA.



6. 8196607
NA



7.
48028
6850149
477130800
70305823



Horizontal
LHD/RHD
Standard

Series B7 TL

Type

Euro III



D7C
7,3l tr.
6 cyl.
183 KW/250 HP

Front pipe

46747
70311854



46755
3172178
20442230
1070460



46746
3195570

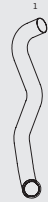

46745
3195567



Silencer

48119
8149232
3162349

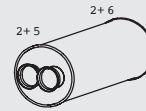

Tail pipe

47984
3178183

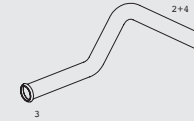

Mounting Parts

1.
00586T



2.
48028
6850149
477130800
70305823



3.
48078
3033054
9522798



4.
00986
3194436



5.
47076
3178175



6.
47075
3178176



Horizontal
LHD
Standard

Series B9 M

Type



B9 M

WB 6000, 6090
6500



Front pipe

Silencer

Tail pipe

48726
1136099

Water Jacket

48728
1190648

WB 6000
Length = 590mm

48562
1136344

48286
1136107

48569
1136349

48384
1136108

48710
1136100

48727
1190200

WB 6090, 6500
Length = 1175mm

18585

CAT

Mounting Parts

1.
00801

2.
48491
1137986

3.
48028
6850149
477130800
70305823

4.
48492
1137987

Horizontal
LHD
Standard

Series B9 M

Type



WB 4600, 5000

20001 ▶CHno
39999

Horizontal
LHD
Standard

Front pipe

48666
3027630
3035172

48612
3034101
3027631
3035864
Incl. water cooled pipe,

48661
3027632
3035890
9517151
Excl. water cooled pipe,

48684
1605629
8152590

47619
9523431

Inox to replace 80245

48611
3035892
9523323

Incl. water cooled pipe, ~~CHno~~ 26167 ▶CHno

48613
3035189
3035891
9517152

Excl. water cooled pipe, ~~CHno~~

47610
9523323

Inox to replace 80244

Silencer

48656
3033353

WB 4600

48536
3032260

48663
3032258

WB 5000

48277
3028909

48531
3027616

Tail pipe

48347
3028914

Mounting Parts

1.
48078
3033054
9522798

2.
48414
508850
1624612
9522768

3.
48028
6850149
477130800
70305823

4.
48026
1206468

5.
48080
3027663

6.
48076
3033362

7.
10476

Series B9 M

Type

1983 →



4X2

B9 M

WB 5500

►CHno4853

Incl.e lectrical
brake



Front pipe

48281
1136090



N.A.
1136094

N.A.
1136092

Silencer

48561
1136113



48288
1136096



48562
1136344



18585
CAT



Tail pipe

48388
1136097

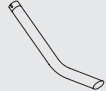

Mounting Parts

1.
00801



2.
48495
1137988



3.
48028
6850149
477130800
70305823



Horizontal
LHD
Standard

Series B9 M

Type

1983 →



④X②

B9 M

WB 5500
Excl.e lectrical
brake

WB 5639
Incl.e lectrical
brake

▶CHno4853



Front pipe

48281
1136090

N.A.
1136094

48796
1136106

WB 5639

Silencer

48561
1136113

Tail pipe

N.A.
1137745

N.A.
1136092
Water Jacket

Mounting Parts

1.
00801

2.
48495
1137988

3.
48028
6850149
477130800
70305823

Horizontal
LHD
Standard

Series B9 M

Type

1983 →

B9 M

WB
6000, 6090, 6500

WB 5639

WB 5500

Excluding

▶CHno4853

Front pipe

Silencer

48710
1136100

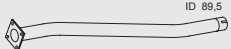

ID 89,5

48728
1190648

WB 5639
Length= 590mm



48562
1136344

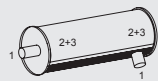

48726
1136099

Water Jacket



48796
1136106

WB 5500
Excl.e lectrical brake
Length= 855 mm



18585

CAT

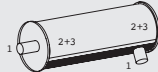

48727
1190200

WB 6000, 6090, 6500
Length= 1175mm



Mounting Parts

1.
00801



2.
48495
1137988



3.
48028
6850149
477130800
70305823



Horizontal
LHD
Standard

Series B9 M

Type

1983 →



B9 M

WB 5500

Incl.e lectrical
brake

4854 ▶CHno

Front pipe

48282
3034693
1191958

48730
1191973

OD 88,9

48729
1608108
1588638
20422024

48724
1190974

48798
1193534

Silencer

48553
1135958

Tail pipe

48365
1193867

Mounting Parts

1.
00640T

2.
00801

3.
48495
1137988

4.
48028
6850149
477130800
70305823

Horizontal
LHD
Standard

Series B9 M

Type

1983 →



B9 M

WB 5500
Incl.e lectrical
brake

4854 ▶CHno

Front pipe

48730
1191973

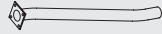

48798
1193534

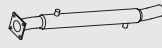

48729
1608108
1588638
20422024



48724
1190974

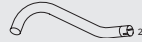

Silencer

48560
1135940

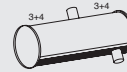

48287
1136394



48553
1135958

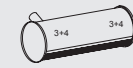

Tail pipe

48366
1191526

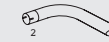

Mounting Parts

1.
00640T



2.
00801



3.
48495
1137988



4.
48028
6850149
477130800
70305823



Horizontal
LHD
Standard

Series B9 M

Type

1983 →



B9 M

WB 5500, 6000,
6096, 6500, 7000

Excl.E lectrical
brake
Excl.R etarder



4854 ▶CHno

Front pipe

48282
3034693
1191958

48730
1191973

48729
1608108
1588638
20422024

48735
1193055

WB 5500, Excl.
electrical brake

48739
1193054

WB 6500

48798
1193534

48731
1193030

WB 5500, Excl.
electrical brake

48734
1193032

WB 6500

Mounting Parts

1.
00640T

2.
00801

3.
48495
1137988

4.
48028
6850149
477130800
70305823

5.
48442
1136606

6.
48026
1206468

Silencer

48562
1136344

18585

CAT

48285
1193061

48560
1135940

Tail pipe

48362
1193065

48363
1193066

48732
1193053

WB 6000

48673
1195455

WB 6096

48733
1193031

WB 6000

48679
1196334

WB 7000

Horizontal
LHD
Standard

Series B9 M

Type

Euro II



Mark IV

THD 101G
9,6l tr.
6 cyl.
160 KW/218 HP
180 KW/245 HP

40000 ▶CHno
41082

Single silencer
system

Front pipe

47737
9515063

Water Jacket

48684
1605629
8152590

Excl. WB 5000
Length = 365 mm

47675
9515103
9517947

WB 6200, 6500, 7000

47680
9515097
9518194

WB 5000

47677
9515101

WB 6000, 7000

47736
9515068

47735
9515170

WB 5000
Length = 220 mm

47678
9515099

WB 5500, 6500

Silencer

48178
9515113

18566

CAT

Tail pipe

47370
9515115

Mounting Parts

1.
48414
508850
1624612
9522768

2.
48403
1594782
1608387

3.
48024
1594267
8157516

4. Alu.
48402
1605164
3943974
20409127

4. Inox
48053
1588971

5.
08768
1581047
1581046

6.
48028
6850149
477130800
70305823

7.
48036
9515953

8.
48026
1206468

Horizontal
LHD
Standard

Series B9 M

Type

Euro II



Mark IV

THD 101G
9,6l tr.
6 cyl.
160 KW/218 HP
180 KW/245 HP

40000 ▶CHno
41082

Twin silencer
system

Front pipe

Silencer

Tail pipe

47737
9515063

Water Jacket

48684
1605629
8152590

47671
9515070

WB 5500, 6500

48535
3027940

48261
9515086

48177
3037196

47373
9515090

47736
9515068

47675
9515103
9517947

WB 6500, 7000

47672
9515072

WB 6000, 7000

18586

CAT

47673
9516488
9517945

WB 6200

Mounting Parts

1.
48414
508850
1624612
9522768

2.
48078
3033054
9522798

3.
08768
1581047
1581046

4.
48028
6850149
477130800
70305823

5.
48080
3027663

6.
48076
3033362

7.
48026
1206468

Horizontal
LHD
Standard

Series B9 M

Type

Euro II



Mark IV

THD 101G

9,6l tr.
6 cyl.
160 KW/218 HP
180 KW/245 HP

41083 ▶CHno

Singles ilencer system

Front pipe

47666
9520417
9957603

Front pipes ▶CHno 43109
not available
Water Jacket

47661
8152558
1608080
22442237

47668
9517985

WB 4800

47670
9517981

WB 6000

47678
9515099

WB 6500

47665
9520418
9957595

Front pipes ▶CHno 43109
not available

47662
9517947

WB 6200, 6500, 7000

47680
9515097
9518194

WB 5000

47677
9515101

WB 7000

Silencer

48178
9515113

18566

CAT

Tail pipe

47370
9515115

Mounting Parts

1.
48414
508850
1624612
9522768

2.
48403
1594782
1608387

3.
48024
1594267
8157516

4.
48402
1605164
3943974
20409127

5.
08768
1581047
1581046

6.
48028
6850149
477130800
70305823

7.
48036
9515953

8.
48026
1206468

9.
48497
1083681
1587517
3943850

Horizontal
LHD
Standard

Series B9 M

Type

Euro II



Mark IV

THD 101G

9,6l tr.
6 cyl.
160 KW/218 HP
180 KW/245 HP

41083 ▶CHno

Twins ilencer system

Front pipe

Silencer

Tail pipe

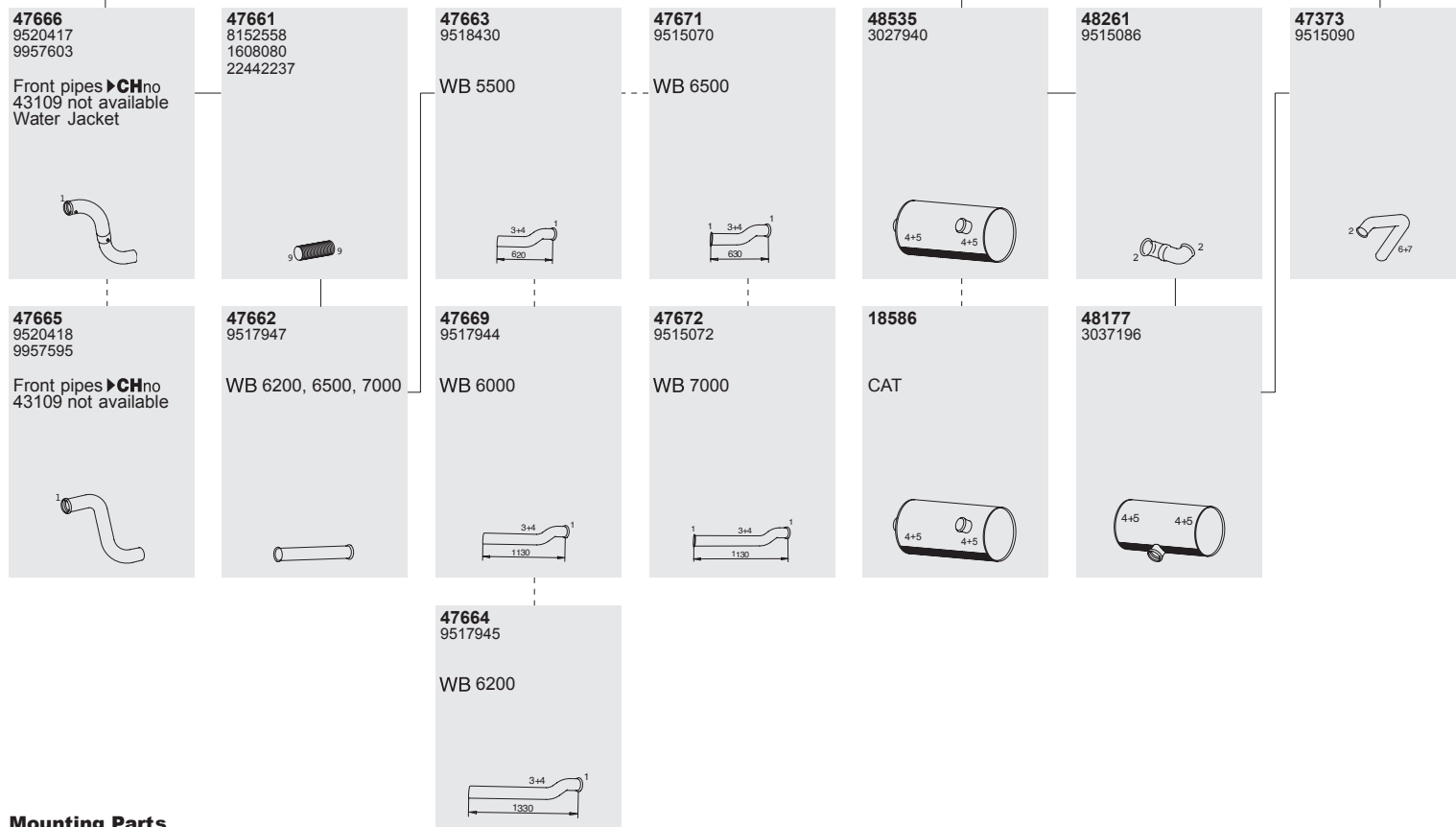

Mounting Parts

- | | | | | | | | |
|--|--|--|--|-------------------------------|-------------------------------|-------------------------------|---|
| 1.
48414
508850
1624612
9522768 | 2.
48078
3033054
9522798 | 3.
08768
1581047
1581046 | 4.
48028
6850149
477130800
70305823 | 5.
48080
3027663 | 6.
48076
3033362 | 7.
48026
1206468 | 8.
48497
1083681
1587517
3943850 |
|--|--|--|--|-------------------------------|-------------------------------|-------------------------------|---|

Horizontal
LHD
Standard

Series B9 TL

Type

Euro IV
2006 →



D9B260
9,4l tr.
6 cyl.
191 KW/260 HP

D9B310
9,4l tr.
6 cyl.
228 KW/310 HP

Front pipe

46666
20719289



46749
20442236



46670
20719290
InsulationI



46587
20757269
CAT



46676
20719291
nsulation



48506
20703415
SCR



48258
20719292



46749
20442236



Tail pipe

46383
20858388



46986
20886023



Mounting Parts

1.
48067
1629499



2.
48497/T
3943850
9957387



3.
48414
508850
1624612
9522768



Horizontal
LHD/RHD
Standard

Series B10 B

Type



B10B

THD 101G
9,6l tr.
6 cyl.
160 KW/218 HP

THD 102 K
9,6l tr.
6 cyl.
203 KW/276 HP

►CHno622

Front pipe

Silencer

Tail pipe

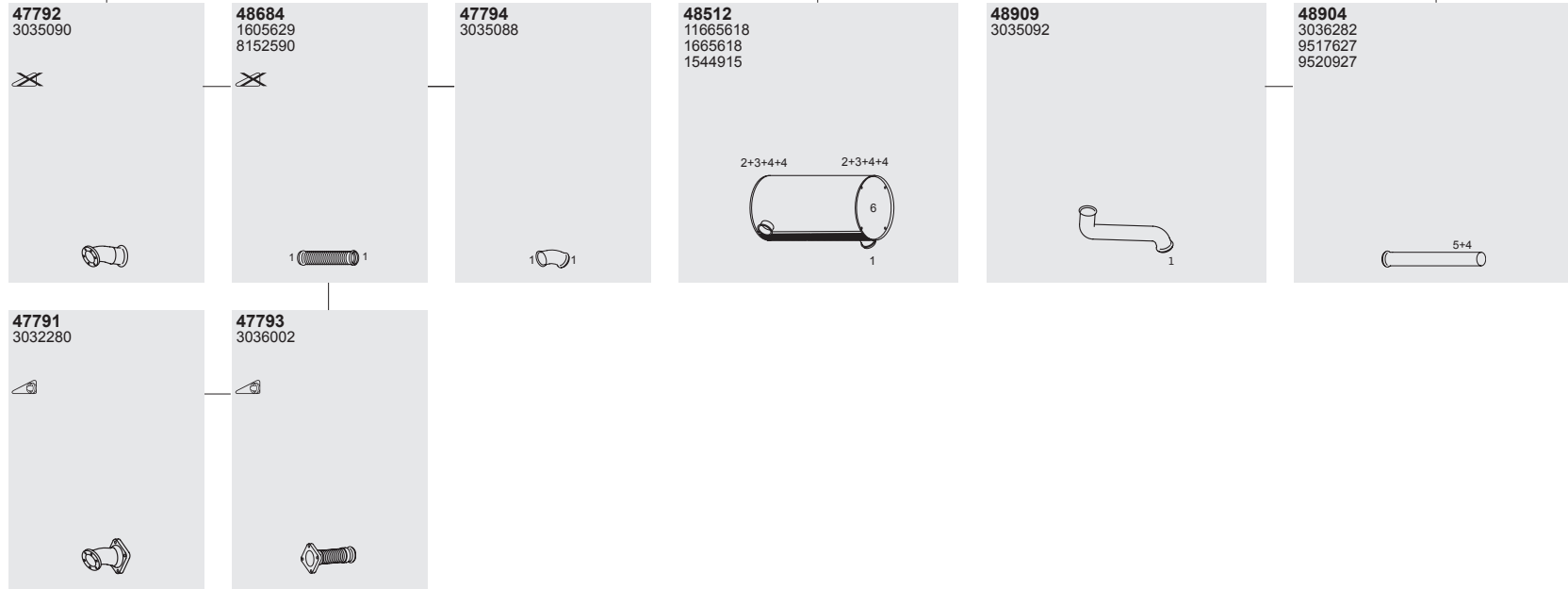

Mounting Parts

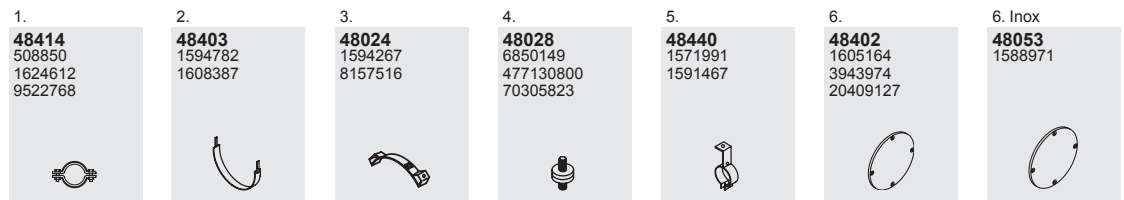

Horizontal
LHD
Standard

Series B10 B

Type

Eure I



B10B

623 ▶CHno 2696

THD 101G

THD 102K

THD 103K

9,6l tr.

6 cyl.

160 KW/218 HP

203 KW/276 HP

210 KW/285 HP

235 KW/320 HP

2697 ▶CHno 2700

THD 104K

9,6l tr.

6 cyl.

180 KW/245 HP

210 KW/285 HP

2704 ▶CHno 2709

THD 104K

9,6l tr.

6 cyl.

180 KW/245 HP

210 KW/285 HP

Front pipe

48684
1605629
8152590

LeftSide outlet
Rear outlet with
3150 mm Rear overhang
Length = 365 mm

47660
9517561

LeftSide outlet
Rear outlet
Standard Rear overhang
2475 ▶CHno

47735
9515170

Rear outlet
Standard Rear overhang
▶CHno 2474
Length= 220 mm

47794
3035088

Rear outlet
Standard Rear overhang
▶CHno 2474

47627
9521631

Standard Rear overhang
2475 ▶CHno
Length= 310 mm

Silencer

48512
11665618
1665618
1544915

2+3+4+4 2+3+4+4

18581

CAT

2+3+4+4 2+3+4+4

48909
3035092

47368
9517566

LeftSide outlet.
765 ▶CHno

Tail pipe

48904
3036282
9517627
9520927
Rear outlet

Mounting Parts

1.
48414
508850
1624612
9522768

2.
48403
1594782
1608387

3.
48024
1594267
8157516

4.
48028
6850149
477130800
70305823

5.
48440
1571991
1591467

6.
48402
1605164
3943974
20409127

6. Inox
48053
1588971

Horizontal
LHD
Standard

Series B10 B

Type

Euro I



B10B

THD 102K
9,6l tr.
6 cyl.
203 KW/276 HP
235 KW/320 HP

Excluding
THG 103K

2697 ▶CHno

Front pipe

48684
1605629
8152590

Lefts ide outlet
Length= 365 mm



47660
9517561



47627
9521631

Rear outlet
With shortr ear
overhang 3150 mm
Length= 310 mm



Silencer

48512
11665618
1665618
1544915

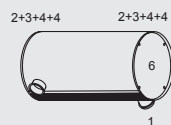

18581

CAT

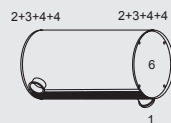

48909
3035092

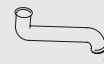

47368
9517566

Lefts ide outlet



Tail pipe

48904
3036282
9517627
9520927

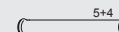

Mounting Parts

1.

48414
508850
1624612
9522768



2.

48403
1594782
1608387



3.

48024
1594267
8157516



4.

48028
6850149
477130800
70305823



5.

48440
1571991
1591467



6.

48402
1605164
3943974
20409127



6. Inox

48053
1588971



Horizontal
LHD
Standard

Series B10 BLE

Type

Euro I



THD 101G
9,6l tr.
6 cyl.
160 KW/218 HP
180 KW/245 HP

THD 102K
9,6l tr.
6 cyl.
158 KW/215 HP
180 KW/245 HP
210 KW/286 HP
252 KW/343 HP

►CHno622

Front pipe

47792
3035090

48684
1605629
8152590

47794
3035088

47791
3032280

47793
3036002

Silencer

48512
11665618
1665618
1544915

48909
3035092

48904
3036282
9517627
9520927

Mounting Parts

1.
48414
508850
1624612
9522768

2.
48403
1594782
1608387

3.
48024
1594267
8157516

4.
48028
6850149
477130800
70305823

5.
48440
1571991
1591467

6.
48402
1605164
3943974
20409127

6. Inox
48053
1588971

Horizontal
LHD
Standard

Series B10 BLE

Type

Euro II



THD 101G
9,6l tr.
6 cyl.
160 KW/218 HP
180 KW/245 HP

THD 102K
9,6l tr.
6 cyl.
158 KW/215 HP
180 KW/245 HP
210 KW/286 HP
252 KW/343 HP

THD 103K
9,6l tr.
6 cyl.
180 KW/245 HP
210 KW/286 HP
250 KW/340 HP

THD 104K
9,6l tr.
6 cyl.
180 KW/245 HP
210 KW/286 HP

623 ▶CHno 2696

2697 ▶CHno 2700

2704 ▶CHno 2709

Front pipe

48684
1605629
8152590

LeftSide and Rear
Length= 365 mm

47660
9517561

LeftSide outlet
Rear Outlet
StandardR ear Overhang
2475 ▶CHno

47735
9515170

Rear Outlet
StandardR ear Overhang
▶CHno 2474
Length= 220 mm

47794
3035088

Rear Outlet
StandardR ear Overhang
▶CHno 2474

47627
9521631

StandardR ear Overhang
2475 ▶CHno
Length= 310 mm

Silencer

48512
11665618
1665618
1544915

18581

CAT

Tail pipe

48909
3035092

48904
3036282
9517627
9520927

Rear Outlet

47368
9517566

Leftside outlet.
765 ▶CHno

Mounting Parts

1.
48414
508850
1624612
9522768

2.
48403
1594782
1608387

3.
48024
1594267
8157516

4.
48028
6850149
477130800
70305823

5.
48440
1571991
1591467

6.
48402
1605164
3943974
20409127

6. Inox
48053
1588971

Horizontal
LHD
Standard

Series B10 BLE

Type

Euro I



THD 102K
9.6l tr.
6 cyl.
158 KW/215 HP
180 KW/245 HP
210 KW/286 HP
252 KW/343 HP

THD 103K
9.6l tr.
6 cyl.
180 KW/245 HP
210 KW/286 HP
250 KW/340 HP

2697 ▶CHno

Front pipe

48684
1605629
8152590

Lefts ide outlet
Length= 365 mm

47660
9517561

47627
9521631

Rear outlet
With shortr ear
overhang 3150 mm
Length= 310 mm

Silencer

48512
11665618
1665618
1544915

2+3+4+4 2+3+4+4

18581

CAT

2+3+4+4 2+3+4+4

Tail pipe

48909
3035092

48904
3036282
9517627
9520927

Rear outlet

47368
9517566

Lefts ide outlet

Mounting Parts

1.
48414
508850
1624612
9522768

2.
48403
1594782
1608387

3.
48024
1594267
8157516

4.
48028
6850149
477130800
70305823

5.
48440
1571991
1591467

6.
48402
1605164
3943974
20409127

6. Inox
48053
1588971

Horizontal
LHD
Standard

Series B10 L

Type

Euro II



GH10

9,6l tr.
6 cyl.
180 KW/245 HP
210 KW/285 HP

THD 103K

9,6l tr.
6 cyl.
180 KW/245 HP
210 KW/285 HP
250 KW/340 HP

THD 104K

9,6l tr.
6 cyl.
180 KW/245 HP
210 KW/285 HP

Front pipe

46780
3112951



47703
8152562
1078120
20442238



Silencer

48115
3112861

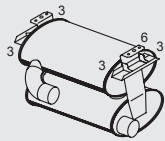

Tail pipe

47331
3112952



47335
3113953
3112953



Mounting Parts

1.
00768
1589141



2.
00572/T
3943850
9957387



3.
48028
6850149
477130800
70305823



4.
48414
508850
1624612
9522768



5.
08768
1581047
1581046



6.
48046
3112875



7.
48045
3118102



Horizontal
LHD
Standard

Series B10 L

Type

Euro II



GH10

9,6l tr.
6 cyl.
180 KW/245 HP
210 KW/290 HP

THD 103K

9,6l tr.
6 cyl.
180 KW/245 HP
210 KW/286 HP
250 KW/340 HP

THD 104K

9,6l tr.
6 cyl.
180 KW/245 HP
210 KW/286 HP

Inox System

Front pipe

47636
3177221
3118791
9522247



47703
8152562
1078120
20442238



Silencer

48116
3118792

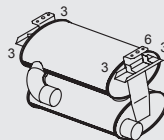

Tail pipe

47315
3118790



47316
3118789



Mounting Parts

1.
00768
1589141



2.
00572/T
3943850
9957387



3.
48028
6850149
477130800
70305823



4.
48414
508850
1624612
9522768



5.
08768
1581047
1581046



6.
48046
3112875



7.
48045
3118102



Horizontal
LHD
Standard

Series B10 LA

Type

Euro II



GH10

9,6l tr.
6 cyl.
180 KW/245 HP
210 KW/285 HP

THD 103K

9,6l tr.
6 cyl.
180 KW/245 HP
210 KW/286 HP
250 KW/340 HP

THD 104K

9,6l tr.
6 cyl.
180 KW/245 HP
210 KW/286 HP

Front pipeT

46780
3112951



47703
8152562
1078120
20442238



Silencer

48115
3112861

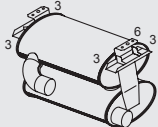

ail pipe

47331
3112952



47335
3113953
3112953



Mounting Parts

1.
00768
1589141



2.
00572/T
3943850
9957387



3.
48028
6850149
477130800
70305823



4.
48414
508850
1624612
9522768



5.
08768
1581047
1581046



6.
48046
3112875



7.
48045
3118102



Horizontal
LHD
Standard

Series B10 LA

Type

Euro II



GH10

9,6l tr.
6 cyl.
180 KW/245 HP
210 KW/285 HP

THD 103K

9,6l tr.
6 cyl.
180 KW/245 HP
210 KW/286 HP
250 KW/340 HP

THD 104K

9,6l tr.
6 cyl.
180 KW/245 HP
210 KW/286 HP

Inox System

Front pipe

47636
3177221
3118791
9522247



47703
8152562
1078120
20442238



Silencer

48116
3118792

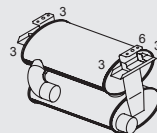

Tail pipe

47315
3118790



47316
3118789



Mounting Parts

1.
00768
1589141



2.
00572/T
3943850
9957387



3.
48028
6850149
477130800
70305823



4.
48414
508850
1624612
9522768



5.
08768
1581047
1581046



6.
48046
3112875



7.
48045
3118102



Horizontal
LHD
Standard

Series B10 M

Type

1983 →



B10M

WB 6000, 6090
6500



Excl.

Front pipe

Silencer

Tail pipe

48726
1136099

WaterJ acket

48728
1190648

WB 6000

48562
1136344

48286
1136107

48569
1136349

48384
1136108

48710
1136100

48727
1190200

WB 6090, 6500

18585

CAT

Mounting Parts

1.
00801

2.
48491
1137986

3.
48028
6850149
477130800
70305823

4.
48492
1137987

Horizontal
LHD
Standard

Series B10 M

Type

→ 1983



④X②

B10M

WB 5500



Excl.

▶CHno4853

Front pipe

Silencer

Tail pipe

48281
1136090



N.A.
1136094

48561
1136113

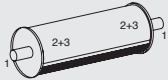

48288
1136096



48562
1136344

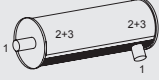

48388
1136097

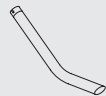

N.A.
1136092

18585
CAT

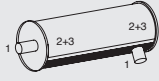

Mounting Parts

1.
00801



2.
48495
1137988



3.
48028
6850149
477130800
70305823



Horizontal
LHD
Standard

Series B10 M

Type

→ 1983



④X②

B10M

WB 5500



WB 5639



Excl.

▶CHno4853

Front pipe

48281
1136090



N.A.
1136094

N.A.
1136092
WaterJ acket

48796
1136106

WB 5639

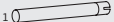

Silencer

48561
1136113

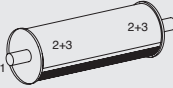

Tail pipe

N.A.
1137745
LHD

Mounting Parts

1.
00801



2.
48495
1137988



3.
48028
6850149
477130800
70305823



Horizontal
LHD
Standard

Series B10 M

Type

→ 1983



④X②

B10M

WB 6000
6090 6500

WB 5639

~~WB 5500~~

Excl.

▶CHno4853

Front pipe

Silencer

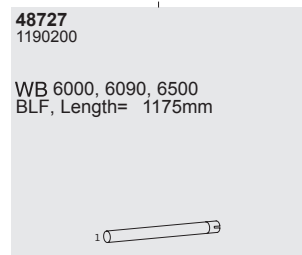
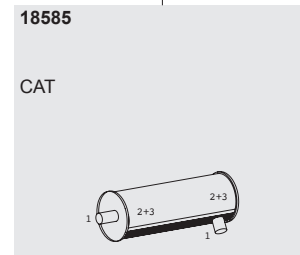
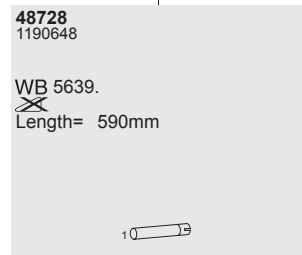
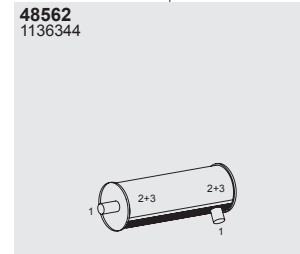
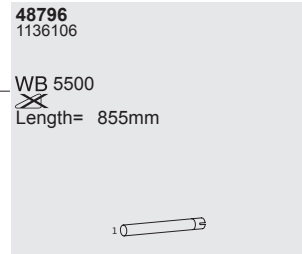
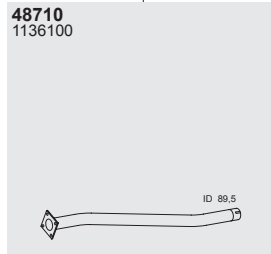

Mounting Parts

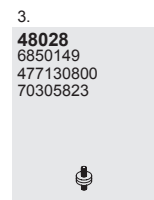
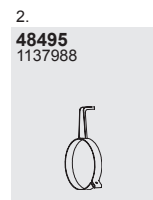

Horizontal
LHD
Standard

Series B10 M

Type

1983 →



4X2

B10M

WB 5500
Incl.e lectrical
brake

4854 ▶CHno

Front pipe

48282
3034693
1191958

48730
1191973

OD 88,9

48729
1608108
1588638
20422024

48724
1190974

Silencer

48553
1135958

Tail pipe

48365
1193867

48798
1193534

Mounting Parts

1.
00640T

2.
00801

3.
48495
1137988

4.
48028
6850149
477130800
70305823

Horizontal
LHD
Standard

Series B10 M

Type

1983 →



B10M

WB 550
Incl.e lectrical
brake

4854 ▶CHno

Front pipe

Silencer

Tail pipe

48730
1191973

48729
1608108
1588638
20422024

48724
1190974

48560
1135940

48287
1136394

48553
1135958

48366
1191526

48798
1193534

Mounting Parts

1.
00640T

2.
00801

3.
48495
1137988

4.
48028
6850149
477130800
70305823

Horizontal
LHD
Standard

Series B10 M

Type

1983 →



B10M

WB 5500, 6000,
6096, 6500, 7000

Excl.e lectrical
brake
Excl.R etarder



4854 ▶CHno

Front pipe

48282
3034693
1191958

48730
1191973

48729
1608108
1588638
20422024

48735
1193055

WB 5500, Uelbroms

48739
1193054

WB 6500

48798
1193534

48731
1193030

WB 5500, Uelbroms

48734
1193032

WB 6500

Mounting Parts

1.
00640T

2.
00801

3.
48495
1137988

4.
48028
6850149
477130800
70305823

5.
48442
1136606

6.
48026
1206468

48732
1193053

WB 6000

48673
1195455

WB 6096

48733
1193031

WB 6000

48679
1196334

WB 7000

Silencer

48562
1136344

18585

CAT

48285
1193061

48560
1135940

Tail pipe

48362
1193065

48363
1193066

Horizontal
LHD
Standard

Series B10 M

Type



 B10M
 WB 4600,5 000
 20001 ▶CHno
 39999

Horizontal
 LHD
 Standard

Front pipe

48666
 3027630
 3035172



48612
 3034101
 3027631
 3035864
 MVA, 



48661
 3027632
 3035890
 9517151
 UVA, 



48684
 1605629
 8152590



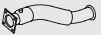

47619
 9523431
 Inox



48611
 3035892
 9523323
 MVA, 
 26167 ▶CHno



48613
 3035189
 3035891
 9517152
 UVA, 



47610
 9523323
 Inox





Silencer

48656
 3033353
 WB 4600

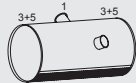

48536
 3032260



48663
 3032258
 WB 5000



48277
 3028909



48531
 3027616

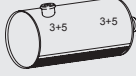

Tail pipe

48347
 3028914

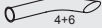

Mounting Parts

1.
48078
 3033054
 9522798



2.
48414
 508850
 1624612
 9522768



3.
48028
 6850149
 477130800
 70305823



4.
48026
 1206468



5.
48080
 3027663



6.
48076
 3033362



7.
10476



Series B10 M

Type

Euro I



Mark III

THD 101GD
9,6l tr.
6 cyl.
160 KW/218 HP

THD 101GC
9,6l tr.
6 cyl.
180 KW/245 HP

20001 ▶CHno
39999

Page 1/2
Next page:
(syst. 280100058)

Horizontal
LHD
Standard

Front pipe

48666
3027630
3035172

48612
3034101
3027631
3035864
For bus with water
jacked exhaust
system.

48661
3027632
3035890
9517151

48684
1605629
8152590

48669
3036287
3027633
WB 5500

48652
3036289
3028913
WB 6250

48535
3027940

47619
9523431
Inox

48655
3032028
WB 6000
20955 ▶CHno

48653
3033548
3027637
WB 6500

18586
CAT

48611
3035892
9523323
For bus with water
jacked exhaust
system.

48613
3035189
3035891
9517152

48651
3027634
WB 6000,
▶CHno 20954

48659
3033550
3027638
WB 7000

47610
9523323
Inox

Mounting Parts

1.
48078
3033054
9522798

2.
48414
508850
1624612
9522768

3.
48028
6850149
477130800
70305823

4.
48080
3027663

5.
10476

Series B10 M

Type

Euro III



Mark III

THD 101GD
9,6l tr.
6 cyl.
160 KW/218 HP

THD 101GC
9,6l tr.
6 cyl.
180 KW/245 HP

20001 ▶CHno
39999

Silencer

Tail pipe

48535
3027940

48283
3027646

WB 5500, 6000, 6250,
6500, 7000
▶CHno 29436

48533
3030046

▶CHno 29436

47354
3034480

18586

CAT

48284
3031992

WB 5500, 5600, 5800,
6000, 6250, 6500, 7000
29437 ▶CHno

48532
3032081

29437 ▶CHno

48399
3033415
3033416

Mounting Parts

1.
48078
3033054
9522798

2.
48028
6850149
477130800
70305823

3.
48026
1206468

4.
48080
3027663

5.
48076
3033362

Page 2/2
Previous page:
(syst. 280100057)

Horizontal
LHD
Standard

Series B10 M

Type

Euro II



Mark IV

THD 100EA
9,6l tr.
6 cyl.
133 KW/180 HP

THD 100D
9,6l tr.
6 cyl.
133 KW/181 HP
160 KW/218 HP
203 KW/276 HP

40000 ▶CHno
41082

Singles ilencer
system

Front pipe

47737
9515063

Water Jacket

48684
1605629
8152590

Excl. WB 5000
Lenght = 365 mm

47675
9515103
9517947

WB 6200, 6500, 7000

47680
9515097
9518194

WB 5000

47677
9515101

WB 6000, 7000

47736
9515068

47735
9515170

WB 5000
Lenght = 220 mm

47678
9515099

WB 5500, 6500

Silencer

48178
9515113

18566

CAT

Tail pipe

47370
9515115

Mounting Parts

1.
48414
508850
1624612
9522768

2.
48403
1594782
1608387

3.
48024
1594267
8157516

4. Inox
48053
1588971

4. Alu.
48402
1605164
3943974
20409127

5.
08768
1581047
1581046

6.
48028
6850149
477130800
70305823

7.
48036
9515953

8.
48026
1206468

Horizontal
LHD
Standard

Series B10 M

Type

Euro I



Mark IV

THD 100EA
9,6l tr.
6 cyl.
133 KW/180 HP

THD 100D
9,6l tr.
6 cyl.
133 KW/181 HP
160 KW/218 HP
203 KW/276 HP

40000 ▶CHno
41082

Twins ilencer
system

Front pipe

Silencer

Tail pipe

47737
9515063

Water Jacket

48684
1605629
8152590

47671
9515070

WB 5500, 6500

48535
3027940

48261
9515086

48177
3037196

47373
9515090

47736
9515068

47675
9515103
9517947

WB 6500, 7000

47672
9515072

WB 6000, 7000

18586

CAT

47673
9516488
9517945

WB 6200

Mounting Parts

1.
48414
508850
1624612
9522768

2.
48028
3033054
9522798

3.
08768
1581047
1581046

4.
48028
6850149
477130800
70305823

5.
48080
3027663

6.
48076
3033362

7.
48026
1206468

Horizontal
LHD
Standard

Series B10 M

Type

Euro I



THD 100 EA
9,6l tr.
6 cyl.
133 KW/180 HP

THD 100D
9,6l tr.
6 cyl.
133 KW/181 HP
160 KW/218 HP
203 KW/276 HP

41083 CHno

Singles ilencer system

Front pipe

47666
9520417
9957603

Front pipes CHno 43109
not available
Water Jacket

47661
8152558
1608080
22442237

47668
9517985

WB 4800

N.A.

9517979
WB 5500

47678
9515099

WB 6500

48178
9515113

47370
9515115

47665
9520418
9957595

Front pipes CHno 43109
not available

47662
9517947

WB 6200, 6500, 7000

47680
9515097
9518194

WB 5000

47670
9517981

WB 6000

47677
9515101

WB 7000

18566

CAT

Mounting Parts

1.
48414
508850
1624612
9522768

2.
48403
1594782
1608387

3.
48024
1594267
8157516

4.
48402
1605164
3943974
20409127

5.
08768
1581047
1581046

6.
48028
6850149
477130800
70305823

7.
48036
9515953

8.
48026
1206468

9.
48497
1083681
1587517
3943850

Horizontal
LHD
Standard

Series B10 M

Type

Euro II



Mark IV

THD 100EA
9,6l tr.
6 cyl.
133 KW/180 HP

THD 100D
9,6l tr.
6 cyl.
133 KW/181 HP
160 KW/218 HP
203 KW/276 HP

41083 ▶CHno

Twins ilencer system

Horizontal
LHD
Standard

Front pipe

47666
9520417
9957603

Front pipes ▶CHno
43109 not available
Water jacket

47665
9520418
9957595

Front pipes ▶CHno
43109 not available

47661
8152558
1608080
22442237

47662
9517947

WB 6500, 7000

47663
9518430

WB 5500

47669
9517944

WB 6000

47664
9517945

WB 6200

47671
9515070

WB 6500
Only with 81225

47672
9515072

WB 7000
Only with 81225

Silencer

48535
3027940

18586

CAT

48261
9515086

48177
3037196

Tail pipe

47373
9515090

Mounting Parts

1.
48414
508850
1624612
9522768

2.
48078
3033054
9522798

3.
08768
1581047
1581046

4.
48028
6850149
477130800
70305823

5.
48080
3027663

6.
48076
3033362

7.
48026
1206468

8.
48497
1083681
1587517
3943850

Series B10 R

Type



B10R

►CHno3111

Silencer

48566
367372
1134343

Mounting Parts

1.
00789Horizontal
LHD
Standard

Series B10 R

Type



B10R

3112 ▶CHno

Front pipe

Silencer

Tail pipe

48714
1136392

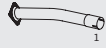

48560
1135940

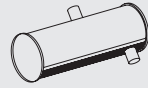

48287
1136394



48560
1135940

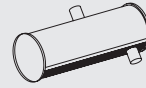

48389
1136395



Mounting Parts

1.
00801



Horizontal
LHD
Standard

Series B10 R

Type

Euro I



THD102 KF
9,6l tr.
6 cyl.
180 KW/245 HP

D10A 360
9,6l tr.
6 cyl.
295 KW/360 HP

Front pipe

48684
1605629
8152590



47657
3034034



Silencer

48512
11665618
1665618
1544915

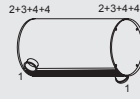

18581

CAT

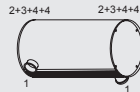

Tail pipe

47367
3034036



Mounting Parts

1.

48414
508850
1624612
9522768



2.

48403
1594782
1608387



3.

48024
1594267
8157516



4.

48028
6850149
477130800
70305823



5.

08768
1581047
1581046



Horizontal
LHD
Standard

Series B12

Type

Euro II



TD 122FH/FL
12,0l tr.
6 cyl.
287 KW/390 HP
291 KW/396 HP

TD 123E/ES
12,0l tr.
6 cyl.
262 KW/390 HP
298 KW/405 HP

1 ▶CHno 4999

Front pipe

Silencer

Tail pipe

48684
1605629
8152590



47795
3035409
9521557



48176
3034185

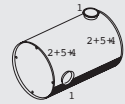

48903
3034992



Mounting Parts

1.
48414
508850
1624612
9522768



2.
48403
1594782
1608387



3.
48440
1571991
1591467



4.
48028
6850149
477130800
70305823



5.
48024
1594267
8157516



Horizontal
LHD
Standard

Series B12

Type

Euro II



TD 122FH/FL
9,6l tr.
6 cyl.
287 KW/390 HP
291 KW/396 HP

TD 123E/ES
9,6l tr.
6 cyl.
262 KW/356 HP
298 KW/405 HP

5000 ▶CHno
99999

Front pipe

Silencer

Tail pipe

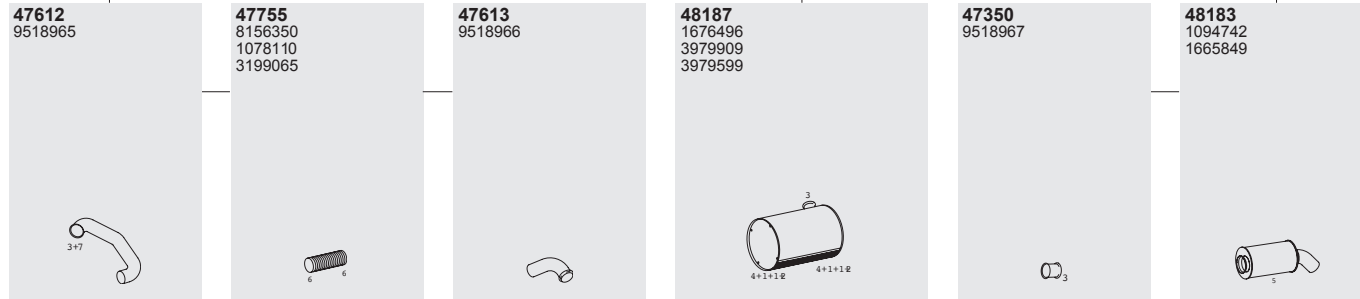

Mounting Parts

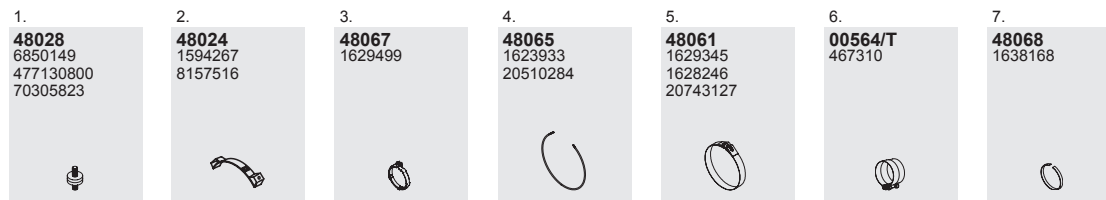

Horizontal
LHD
Standard

Series B12 B

Type

Euro III



TD 122FH
12,0l tr.
6 cyl.
262 KW/356 HP

D 12A420
12,1l tr.
6 cyl.
309 KW/420 HP

Front pipe

Silencer

Tail pipe

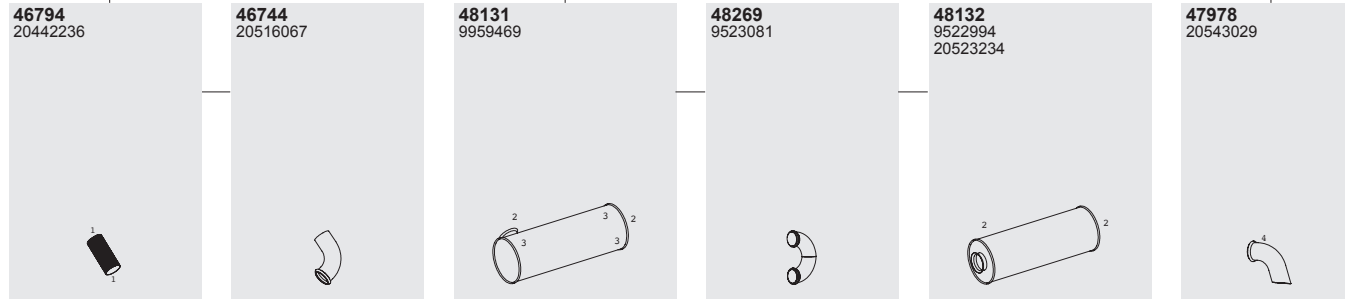

Mounting Parts

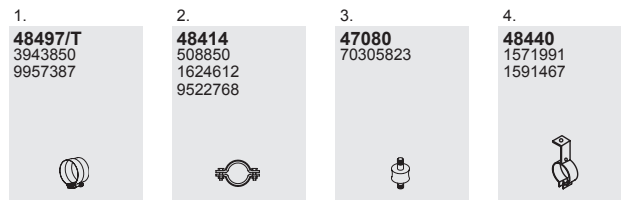

Horizontal
LHD
Standard

Series B12 M

Type

Euro III



TD 122FH
12,0l tr.
6 cyl.
262 KW/356 HP

D 12A420
12,1l tr.
6 cyl.
309 KW/420 HP

Front pipe

Silencer

Tail pipe

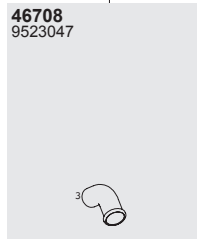
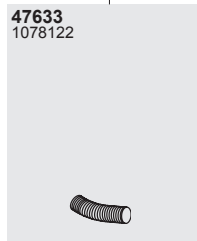
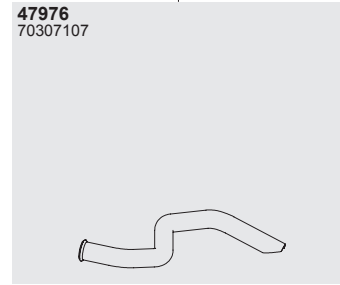
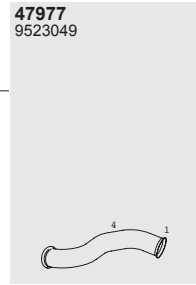
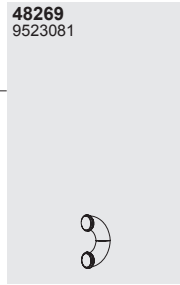
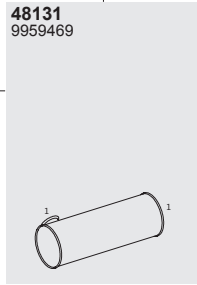
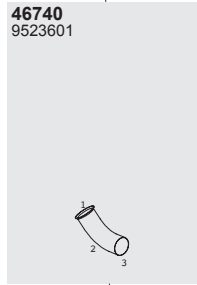

Mounting Parts

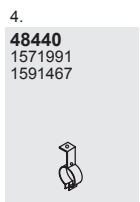
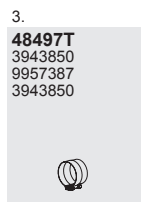
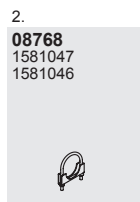

Horizontal
LHD
Standard

Series B54

Type



B54

D5 0
 5,1l tr.
 6 cyl.
 79 KW/107 HP
 86 KW/117 HP

Horizontal
 LHD
 Standard

Front pipe

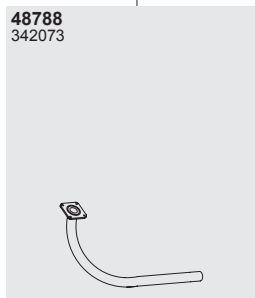

Silencer

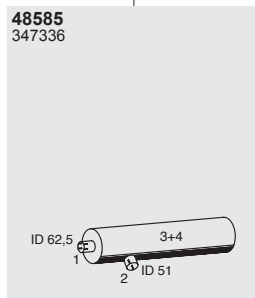

Mounting Parts

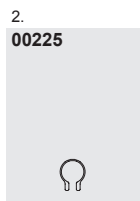
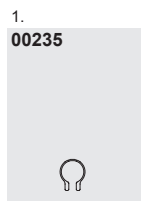

Series B54

Type



B54

D5 0
 5,1l tr.
 6 cyl.
 79 KW/107 HP
 86 KW/117 HP

5021 ▶CHno

Front pipe



Silencer

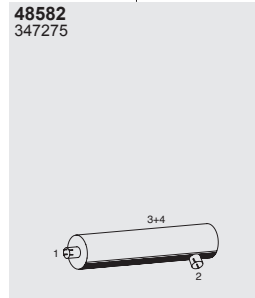

Mounting Parts

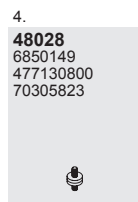
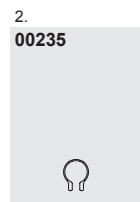
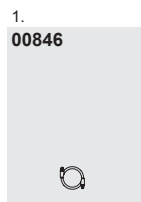

Horizontal
 LHD
 Standard

Series B57

Type



B57

TD70

Silencer

48583
347057
1194359



Mounting Parts

1.
00801

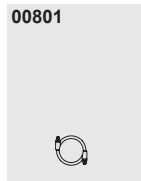

2.
00846

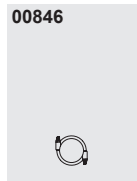

Horizontal
LHD
Standard

Series B58

Type

→ 1977

B58

TD 100

▶CHno9764

Front pipeT

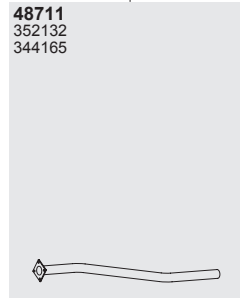

Silencer

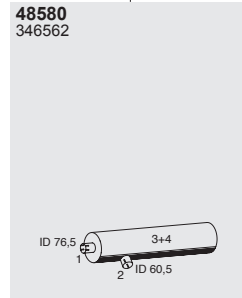

ail pipe



Mounting Parts

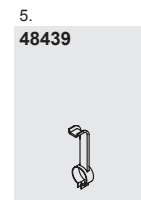
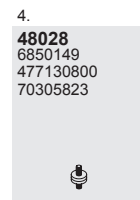
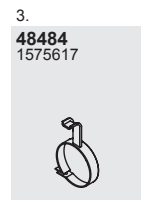
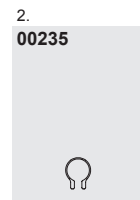
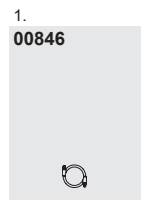

Horizontal
LHD
Standard

Series B58

Type

1977 →



4X2

B58

WB 5500, 6000
6100, 6500

9765 ▶CHno

Front pipeT

Silencer

ail pipe

48720
365629

WB 6500
Length= 1070 mm

48566
367372
1134343

48368
1130057

WB 5500, With Telma

48719
365461

WB 6000
Length= 570 mm

48386
1130055

WB 5500, 6000, 6500

Mounting Parts

1.
00789

2.
48796
1132037

3.
48446
365738

Horizontal
LHD
Standard

Series B59

Type

1977 →



4X2

B59

WB 5500, 6000
6100, 6500

9765 ▶CHno

Front pipe

Silencer

Tail pipe

48720
365629

WB 6500
Length= 1070 mm

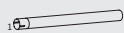

48566
367372
1134343



48368
1130057

WB 5500, WithTelma



48719
365461

WB 6000
Length= 570 mm



48386
1130055

WB 5500, 6000, 6500

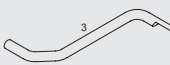

Mounting Parts

1.
00789



2.
48469
1132037



3.
48446
365738



Horizontal
LHD
Standard

Series DH 10A

Type



DH 10A

623 ▶CHno 2696

THD 101G

THD 102K

THD 103K

2697 ▶CHno 2700

THD 104K

2704 ▶CHno 2709

THD 104K

Front pipe

Silencer

Tail pipe

48684
1605629
8152590

LeftS ideO outlet
Rear Outlet With
3150mmR ear Overhang
Length = 365 mm

47660
9517561

LeftS ideO outlet
Rear Outlet
StandardR ear Overhang
2475 ▶CHno

48512
11665618
1665618
1544915

48909
3035092

48904
3036282
9517627
9520927

Rear Outlet

47735
9515170

Rear Outlet
StandardR ear Overhang
▶CHno 2474
Length = 220 mm

47794
3035088

Rear Outlet
StandardR ear Overhang
▶CHno 2474

18581

CAT

47627
9521631

StandardR ear Overhang
2475 ▶CHno
Length = 310 mm

Mounting Parts

1.
48414
508850
1624612
9522768

2.
48403
1594782
1608387

3.
48024
1594267
8157516

4.
48028
6850149
477130800
70305823

5.
48440
1571991
1591467

6. Inox
48053
1588971

6.
48402
1605164
3943974
20409127

Horizontal
LHD
Standard

SOYLU / OTOBÜS

VW



LT

578

Crafter

591

Series LT

Type

Euro 1
08/88 → 12/95



4X4

1S
2,4 ltr.
6 cyl.
51 KW/70 HP
08/88 → 07/92

4X2

ACT
2,4 ltr.
6 cyl.
51 KW/70 HP
08/92 → 12/95

Front pipe Silencer Tail pipe

91714
073253101J

WB 2500/3650

91574
075253411D

91283
075253681AA

281, 282, 291, 292,
21A, 21B, 21D, 21E

91283
075253101L

WB 2950

91778
075253681R

283-286, 293,
296, 21C, 21F, 21G,
21H, 21K

Mounting Parts

1.
91468
076253117A

2.
91467
076253225

3.
91466
433253115

4.
91479

5.
91461
855253137A

6.
91424
447253137

7.
28083
8A0253147A

8.
91470
075253457

Horizontal
LHD/RHD
Standard

Series LT

Type

12/82 → 07/92



4X2
4X4

DW
2,4l tr.
6 cyl.
55 KW/75H P

HS
2,4l tr.
6 cyl.
62 KW/82H P

Front pipeT

Silencer

ail pipe

91714
073253101J

WB 2500/3650

91574
075253411D

DW, CH A, 4X2, 4X4

91286
073253681D

Truck, 281, 282, 291, 292

91288
073253681F

DW: 291, 21A, 21B, 21D, 2 1F.H S.
4X2, 4X4

91777
075253101H

Allw heel drive(DW)

91551
075253411A

HS: 4X4

91285
073253681N

Truck, HS+DW: 283, 286, 293, 296. DW

91284
075253681AC

DW: 4X4

91778
075253101L

WB 2950

91552
075253411C

DW: 4X2, 4X4

91287
073253681G

Truck, 281, 282, 291, 292, 21A-B, 21D-E

91281
073253681E

DW: 293, 295, 21C, 2 1F, 21G, 21H, 21K.
HS: 4X2, 4X4

91289
075253681R

Truck

91278
075253681E

DW

Mounting Parts

1.
91468
076253117A

2.
91467
076253225

3.
91466
433253115

4.
91479

5. (50/50)
91461
855253137A

6.
28083
8A0253147A

7.
91470
075253457

8. (60/60)
91424
447253137

9.
91473
291253881A

Horizontal
LHD/RHD
Standard

Series LT

Type

08/88 → 07/92



④X②
④X④

1G
2,4l tr.
6 cyl.
68 KW/92H P

Front pipeT

Silencer

ail pipe

91779
075253101D

④X④

91557
075253411G

91273
075253681S

④, 283-286, 293-296;
M350/M512: 293-296

91773
075253101M

WB 2650
Total weight: up to 4.600 kg

91275
075253681AB

④, 281, 282, 291, 292

91774
075253101P

WB 2500/2950

91772
075253101B

Total weight: from 4.600 kg

Mounting Parts

1.
91479

2.
28083
8A0253147A

3.
91470
075253457

4.
91474
075253115

5.
91424
447253137

6. (70/70)
91471
075253137

7.
91473
291253881A

Horizontal
LHD/RHD
Standard

Series LT

Type

Euro 1
08/91 → 12/95



ACL
2.4l tr.
6 cyl.
70 KW/95H P

Front pipe

Silencer

Tail pipe

91774
075253101P

WB 2500/2950/3650
Total weight: from 4.600 kg

91557
075253411G

91275
075253681AB

281, 282, 291, 292, 21A, 21B, 21D, 21E

91770
075253101S

WB 2950
Total weight: up to 4.600 kg

91553
075253411B

4x4

91273
075253681S

285, 286, 295, 296, 21C, 21F, 21G, 21H, 21K.

91768
075253101R

All wheel drive

91553
075253411B

4x4

91278
075253681E

285, 286, 295, 296, 21C, 21F, 21G, 21H, 21K. 4x4

91384
075253681AC

291, 21A, 21B, 21D, 21E. 4x4

Mounting Parts

1.
91474
075253115

2.
91479

3.
91424
447253137

4.
28083
8A0253147A

5.
91470
075253457

6.
91471
075253137

7. 291 292 21A 21B 21D 21E: (1E DV) (59,5mm)

91473
291253881A

7. 291 292 21A 21B 21D 21E AD V

91475
291253881B

Horizontal
LHD/RHD
Standard

Series LT

Type

12/82 → 07/92



④X②
④X④

DV
2,4l tr.
6 cyl.
75 KW/102 HP

Front pipe

Silencer

Tail pipe

91772
075253101B

Total weight: from 4 .600 kg

91553
075253411B

91282
075253681D

Truck, M 512: 291, 292

91284
075253681AC

291 ④X④

91773
075253101M

WB 2950
Total weight: up to 4 .600 kg

91289
075253681R

Truck, 283-286, M512: 293-296

91279
075253681E

293, 295 ④X④

91779
075253101D

④X④

91283
075253681AA

Truck, 281, 282, M512: 291, 292

91271
075253681L

Truck, CH: M 512: 291, 292

91557
075253411G

91272
075253681K

Truck, CH: M 512: 293-296

Mounting Parts

1.
91479

2.
28083
8A0253147A

3.
91470
075253457

4.

5.
91424
447253137

6. (60/60)
91424
447253137

7. (70/70)
91471
075253137

8. (291,292)
91473
291253881A

9. (291, 292, A, (21B, 21D, 21E)
91475
291253881B

Horizontal
LHD/RHD
Standard

Series LT

Type

Euro 3
05/96 → 04/01



AGX
2,5l tr.
5 cyl.
55 KW/75H P

OPO -R ear
outlet
OP1 -S ide outlet

Front pipe

91763
2D0253091F



91515
2D0131701EX

CAT



Silencer

91511
2D0253409L

OPO

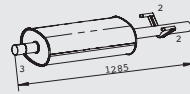

Tail pipe

91266
2D0253681AL

WB 3000



91267
2D0253681AD

WB 4025
Total weight: 4.600 kg

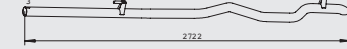

91265
2D0253681AE

WB 3550
Total weight: 4.600 kg

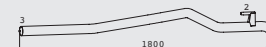

91263
2D0253681AJ

WB 4025
Total weight: 3.500 kg



91261
2D0253681AK

WB 3550



91513
2D0253409M

OP1

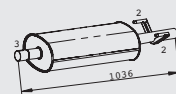

91269
2D0253681AR

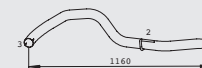

Mounting Parts

1.

91415
021253115



2.

28042
2D0253144
2D0253144A



3.

00232
535253139



4.

91758
357253141A
7H0253141A



Horizontal
LHD/RHD
Standard

Series LT

Type

Euro 3
05/99 →



APA
2,5l tr.
5 cyl.
66 KW/90H P

OPO -R ear
outlet
OP1 -S ide outlet

Front pipe

91517
2D0253208KX

CAT
2D-1H013770 ▶CHno

91262
2D0253091J
2D0254300B

▶CHno 2D-1H013769

91516
2D0131701FX

CAT
▶CHno 2D-1H013769

Mounting Parts

1.
91458
2D0253115A

2.
28042
2D0253144
2D0253144A

3.
00232
535253139

4.
91763
893253139B

Horizontal
LHD/RHD
Standard

Silencer

91511
2D0253409L

OPO

91513
2D0253409M

OP1

Tail pipe

91266
2D0253681AL

WB 3000

91265
2D0253681AE

WB 3550
Total weight: 4 .600 kg

91261
2D0253681AK

WB 3550

91269
2D0253681AR

91263
2D0253681AJ

WB 4025

91267
2D0253681AD

WB 4025
Total weight: 4 .600 kg

Series LT

Type

Euro 3
04/01 →



BBE
2,5l tr.
5 cyl.
61 KW/83H P

BBF
2,5l tr.
5 cyl.
70 KW/95H P

OPO -R ear
outlet
OP1 -S ide outlet

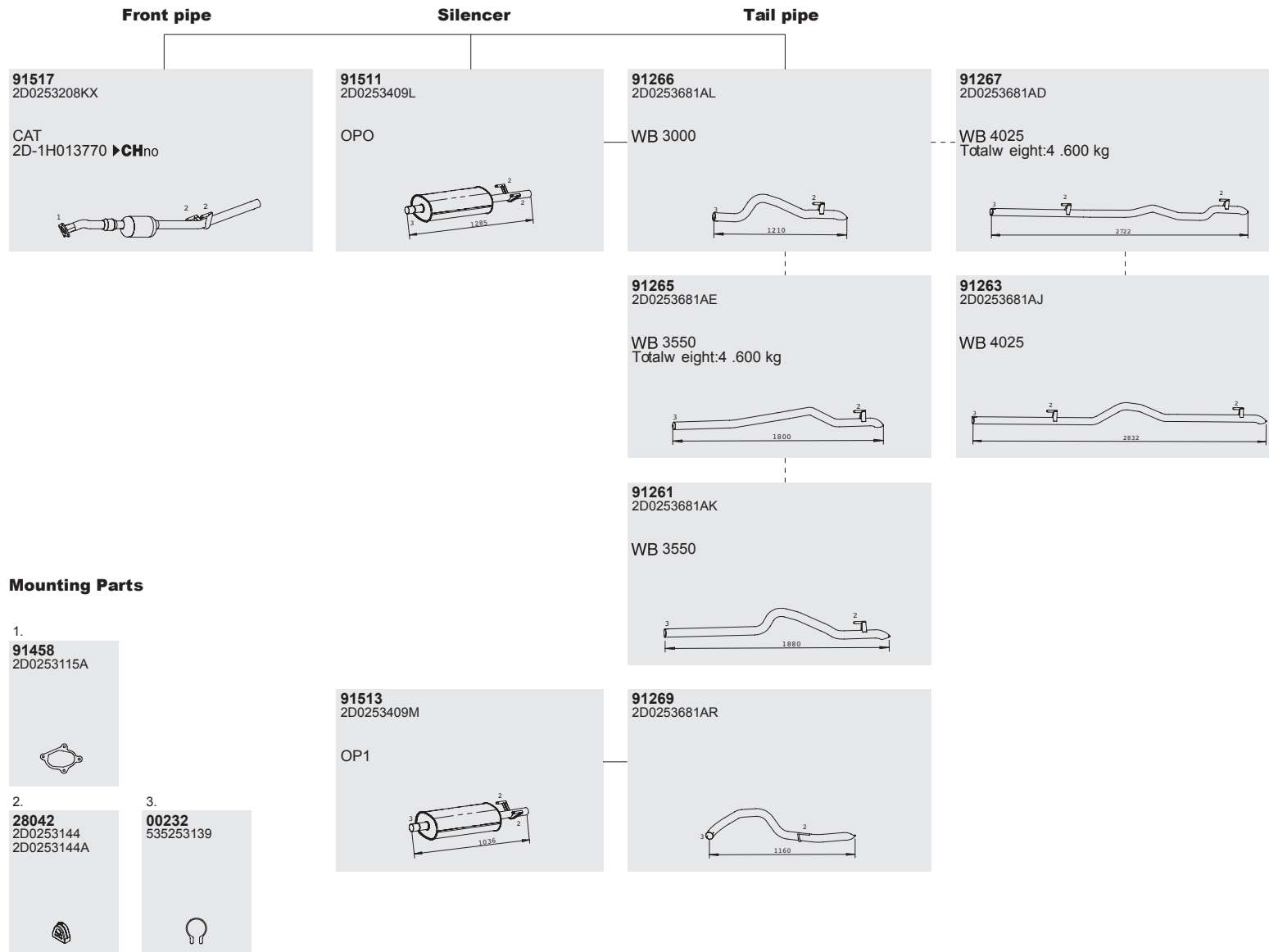

Horizontal
LHD/RHD
Standard

Series LT

Type

Euro 2
05/96 → 05/99



AHD
2,5l tr.
5 cyl.
75 KW/102 HP

OPO -R ear
outlet
OP1 -S ide outlet

Front pipe

91762
2D0253091J
2D0254300B

▶CHno 2D-1H013769



91516
2D0131701FX

CAT
▶CHno 2D-1H013769

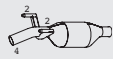

Silencer

91511
2D0253409L

OPO

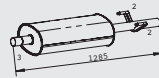

Tail pipe

91266
2D0253681AL

WB 3000

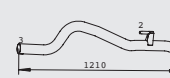

91263
2D0253681AJ

WB 4025

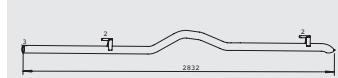

91264
2D0253681AK

WB 3550

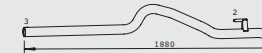

91267
2D0253681AD

WB 4025
Totalw eight:4 .600 kg

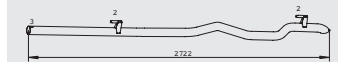

91265
2D0253681AE

WB 3550
Totalw eight:4 .600 kg

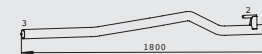

Mounting Parts

1.
91458
2D0253115A



2.
28042
2D0253144
2D0253144A



3.
00232
535253139



4.
91760
893253139B



91513
2D0253409M

OP1

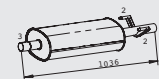

91269
2D0253681AR

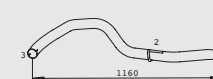

Horizontal
LHD/RHD
Standard

Series LT

Type

Euro 3
05/99 →



ANJ
2,5l tr.
5 cyl.
80 KW/109 HP

OPO -R ear
outlet
OP1 -S ide outlet

Front pipe

91518
2D0253208LX
2D0253208SX

CAT
2D-1H013770 ▶CHno

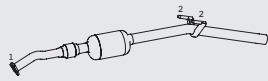

91764
2D0253091G
2D0254300C

▶CHno 2D-1H013769



91516
2D0131701FX

CAT
▶CHno 2D-1H013769

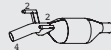

Mounting Parts

1.
91419
6N0253115B



2.
28042
2D0253144
2D0253144A



3.
00232
535253139



Silencer

91511
2D0253409L

OPO

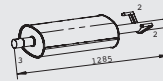

91513
2D0253409M

OP1

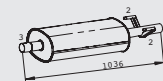

Tail pipe

91266
2D0253681AL

WB 3000

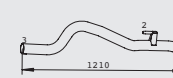

91261
2D0253681AK

WB 3550



91265
2D0253681AE

WB 3550
Totalw eight:4 .600 kg

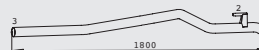

91269
2D0253681AR



91267
2D0253681AD

WB 4025
Totalw eight:4 .600 kg

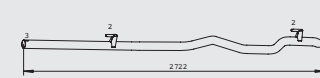

91263
2D0253681AJ

WB 4025

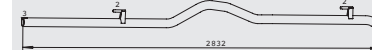

Horizontal
LHD/RHD
Standard

Series LT

Type

Euro 2
07/97 → 12/98



AGK
2,8l tr.
4 cyl.
92 KW/125 HP

OPO -R ear
outlet
OP1 -S ide outlet

Front pipeT

91769
2D0253091L

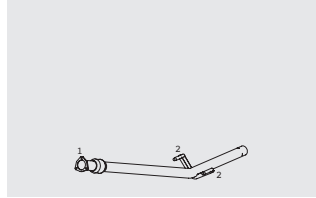

Silencer

91511
2D0253409L

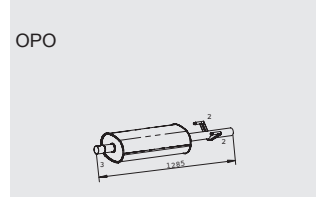

ail pipe

91266
2D0253681AL

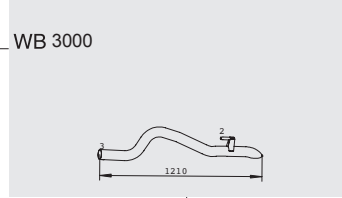

91267
2D0253681AD

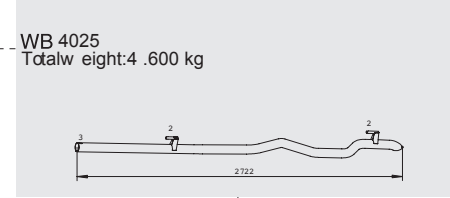

91265
2D0253681AE

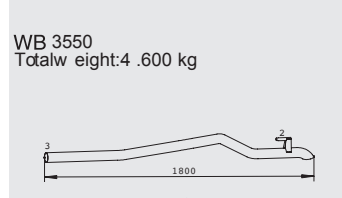

91263
2D0253681AJ

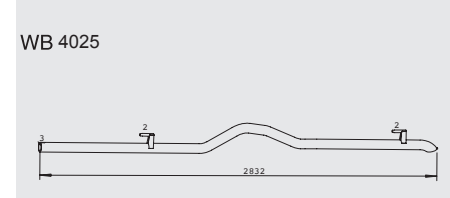

91261
2D0253681AK

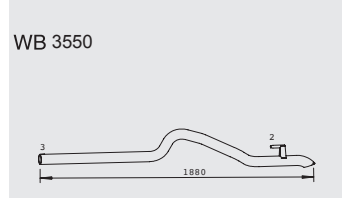

Mounting Parts

1.
91411
1H0253115

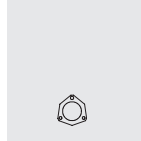

2.
28042
2D0253144
2D0253144A



3. (64,5)
00235

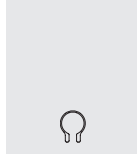

91513
2D0253409M

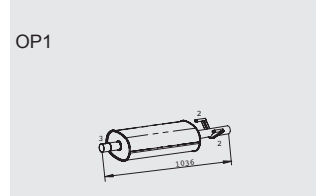

91269
2D0253681AR

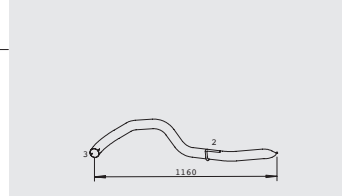

Horizontal
LHD/RHD
Standard

Series LT

Type

Euro 3
01/99 →



ATA
2,8l tr.
4 cyl.
96 KW/130 HP

OPO -R ear
outlet
OP1 -S ide outlet

Front pipe

91769
2D0253091L

Silencer

91511
2D0253409L

OPO

Tail pipe

91266
2D0253681AL

WB 3000

91267
2D0253681AD

WB 4025
Total weight: 4.600 kg

91265
2D0253681AE

WB 3550
Total weight: 4.600 kg

91263
2D0253681AJ

WB 4025

Mounting Parts

1.
91411
1H0253115

2.
28042
2D0253144
2D0253144A

3.
00232
535253139

91513
2D0253409M

OP1

91261
2D0253681AK

WB 3550

91269
2D0253681AR

Horizontal
LHD/RHD
Standard

Series LT

Type

Euro 3
02/02 →



AUH
2,8l tr.
4 cyl.
116K W/158 HP

OPO -R ear
outlet
OP1 -S ide outlet

Front pipeT Silencer ail pipe

91769
2D0253091L

91511
2D0253409L

OPO

91266
2D0253681AL

WB 3000

91267
2D0253681AD

WB 4025
Totalw eight:4 .600 kg

91265
2D0253681AE

WB 3550
Totalw eight:4 .600 kg

91263
2D0253681AJ

WB 4025

91261
2D0253681AK

WB 3550

Mounting Parts

1.
91411
1H0253115

2.
28042
2D0253144
2D0253144A

3.
00232
535253139

91513
2D0253409M

OP1

91269
2D0253681AR

Horizontal
LHD/RHD
Standard

Series CRAFTER

Type

Euro 3/4
04/2006 →



Front pipeT	Silencer	ail pipe	
<p>91575 2E0254700GX</p> <p>DPF Euro 4</p>	<p>91584 2E0253409L</p> <p>Total weight: 3.500 kg</p>	<p>91381 2E053681</p> <p>WB 3250</p>	<p>91378 2E0253681F</p> <p>WB 4325</p>
<p>91588 2E0254200AX</p> <p>CAT Euro 3</p>	<p>91586 2E0253409J</p>	<p>91382 2E0253681A</p> <p>WB 3665</p>	<p>91375 2E0253681K 2E0253681AG 2E0253681AF</p> <p>WB 4325 Total weight: 5.000 kg</p>
	<p>91577 2E0253409M</p>	<p>91377 2E0253681H</p> <p>WB 3665 Total weight: 5.000 kg</p>	<p>91376 2E0253681J</p> <p>WB 4325 Total weight: 5.000 kg</p>

Mounting Parts

<p>1. 91489 7H0253115B 7H0253115T</p>	<p>2. 91480 7H0253725A</p>	<p>3. 28042 2D0253144 2D0253144A</p>	<p>4. 91478 2E0253653 2E0253653D</p>	<p>5. 00897 2E0253139</p>	<p>6. 91477 2E0253725</p>
--	---	---	---	--	--

Horizontal
LHD/RHD
Standard

Series CRAFTER

Type

Euro 4
04/2006 →



BJL
2,5ltr.T DI
5 cyl.
100 KW/136 HP

Front pipeT

91575
2E0254700GX

DPF

Silencer

91584
2E0253409L

ail pipe

91371
2E0253681L

WB 3250

91373
2E0253681S

WB 4325

91383
2E0253681AC

WB 3665
Total weight: 5.000 kg

91379
2E0253681T

WB 4325
Total weight: 5.000 kg

91372
2E0253681M

WB 3665

91389
2E0253681AD

WB 4325
Total weight: 5.000 kg

Mounting Parts

1.
91477
2E0253725

2.
00897
2E0253139

3.
28042
2D0253144
2D0253144A

4.
91478
2E0253653
2E0253653D

5.
91489
7H0253115B
7H0253115T

6.
91480
7H0253725A

91384
2E0253681AE

WB 3665
Total weight: 5.000 kg

Horizontal
LHD/RHD
Standard

Series CRAFTER

Type

Euro 4
04/2006 →



BJJ
2,5l tr.T DI
5 cyl.
65 KW/88H P

Front pipe

91575
2E0254700GX

DPF



Silencer

91576
2E0253409N

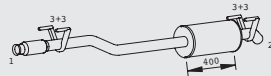

Tail pipe

91374
2E0253681B

WB 3665

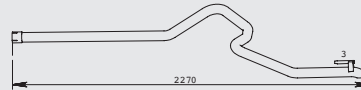

91368
2E0253681D

WB 4325

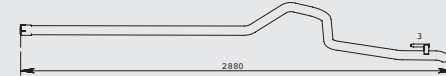

91370
2E0253681C

WB 3665

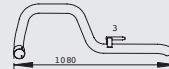

91367
2E0253681E

WB 4325

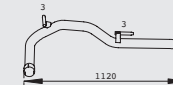

Mounting Parts

1.
91477
2E0253725



2.
00897
2E0253139



3.
28042
2D0253144
2D0253144A



4.
91478
2E0253653
2E0253653D



5.
91489
7H0253115B
7H0253115T



6.
91480
7H0253725A



Horizontal
LHD/RHD
Standard

Series CRAFTER

Type

Euro 4
04/2006 →



BJL
2,5l tr. CDI
5 cyl.
100 KW/136 HP

Front pipe

91575
2E0254700GX

DPF

Silencer

91589
2E0253409K

Tail pipe

91361
2E0253681Q

WB 3665

91366
2E0253681N

WB 4325

91365
2E0253681P

WB 3665

91362
2E0253681R

WB 4325

Mounting Parts

1.
91477
2E0253725

2.
00897
2E0253139

3.
28042
2D0253144
2D0253144A

4.
91478
2E0253653
2E0253653D

5.
91489
7H0253115B
7H0253115T

6.
91480
7H0253725A

Horizontal
LHD/RHD
Standard

Series CRAFTER

Type

Euro 3/4
04/2006 →



BJM
2,5l tr.T DI
5 cyl.
120 KW/163 HP

Front pipeT

Silencer

ail pipe

91575
2E0254700GX

DPF
Euro 4



91586
2E0253409J

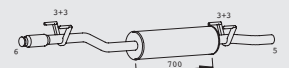

91371
2E0253681L

WB 3250

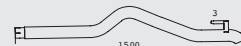

91373
2E0253681S

WB 4325

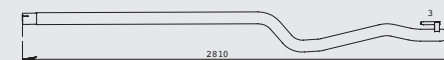

91588
2E0254200AX

CAT
Euro 3



91584
2E0253409L

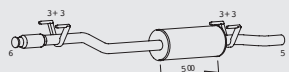

91372
2E0253681M

WB 3665



91379
2E0253681T

WB 4325
Total weight: 5.000 kg

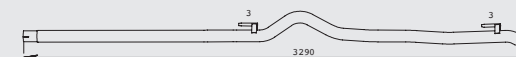

Mounting Parts

1.
91489
7H0253115B
7H0253115T



2.
91480
7H0253725A



3.
28042
2D0253144
2D0253144A



4.
91478
2E0253653
2E0253653D



5.
00897
2E0253139



6.
91477
2E0253725



91383
2E0253681AC

WB 3665
Total weight: 5.000 kg



91384
2E0253681AE

WB 3665
Total weight: 5.000 kg

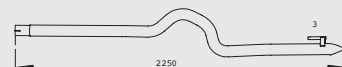

91389
2E0253681AD

WB 4325
Total weight: 5000 kg

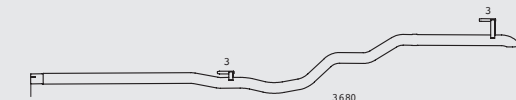

Horizontal
LHD/RHD
Standard

Series CRAFTER

Type

Euro 3/4
04/2006 →



BJM
2,5l tr.T DI
5 cyl.
120 KW/163 HP

Front pipe

Silencer

Tail pipe

91575
2E0254700GX

DPF
Euro 4

91587
2E0253409H

Total weight: 3.500 kg

91361
2E0253681Q

WB 3665

91366
2E0253681N

WB 4325

91588
2E0254200AX

CAT
Euro 3

91589
2E0253409K

91365
2E0253681P

WB 3665

91362
2E0253681R

WB 4325

Mounting Parts

1.
91489
7H0253115B
7H0253115T

2.
91480
7H0253725A

3.
28042
2D0253144
2D0253144A

4.
91478
2E0253653
2E0253653D

5.
00897
2E0253139

6.
91477
2E0253725

Horizontal
LHD/RHD
Standard

Series CRAFTER

Type

Euro 3/4
04/2006 →



BJK
2,5l tr.
5 cyl.
80 KW/109 HP

Front pipeT

Silencer

ail pipe

91575
2E0254700GX

DPF
Euro 4

91587
2E0253409H

Total weight: 3.500 kg

91374
2E0253681B

WB 3665

91368
2E0253681D

WB 4325

91588
2E0254200AX

CAT
Euro 3

91589
2E0253409K

Total weight: 3500 kg

91370
2E0253681C

WB 3665

91367
2E0253681E

WB 4325

91576
2E0253409N

Mounting Parts

1.
91489
7H0253115B
7H0253115T

2.
91480
7H0253725A

3.
28042
2D0253144
2D0253144A

4.
91478
2E0253653
2E0253653D

5.
00897
2E0253139

6.
91477
2E0253725

Horizontal
LHD/RHD
Standard

**SOYLU EGZOZ YEDEK PARÇA
SAN. VE TİC. LTD. ŞTİ.**

İkitelli OSB. Dolapdere Sanayi Sitesi 5. Ada No: 8-10
İkitelli 34306 Başakşehir İstanbul Türkiye
T +90 212 671 12 27 - 28 - 77
F +90 212 671 12 29
info@soylu.com www.soylu.com

HER KİLOMETREDE YENİ / NEWER IN EVERY MILE

